

**LOW POWER DUAL OPERATIONAL AMPLIFIERS**

- INTERNALLY FREQUENCY COMPENSATED
- LARGE DC VOLTAGE GAIN : 100dB
- WIDE BANDWIDTH (unity gain) : 1.1MHz (temperature compensated)
- VERY LOW SUPPLY CURRENT/AMPLI (500µA) - ESSENTIALLY INDEPENDENT OF SUPPLY VOLTAGE
- LOW INPUT BIAS CURRENT : 20nA (temperature compensated)
- LOW INPUT OFFSET VOLTAGE : 2mV
- LOW INPUT OFFSET CURRENT : 2nA
- INPUT COMMON-MODE VOLTAGE RANGE INCLUDES GROUND
- DIFFERENTIAL INPUT VOLTAGE RANGE EQUAL TO THE POWER SUPPLY VOLTAGE
- LARGE OUTPUT VOLTAGE SWING 0V TO (V<sub>CC</sub> - 1.5V)

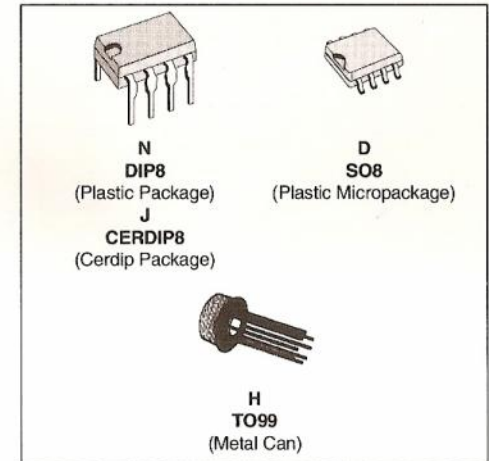

**DESCRIPTION**

These circuits consist of two independent, high gain, internally frequency compensated which were designed specifically to operate from a single power supply over a wide range of voltages. The low power supply drain is independent of the magnitude of the power supply voltage.

Application areas include transducer amplifiers, dc gain blocks and all the conventional op-amp circuits which now can be more easily implemented in single power supply systems. For example, these circuits can be directly operated off the standard +5V power supply voltage which is used in logic systems and will easily provide the required interface electronics without requiring any additional power supply.

In the linear mode the input common-mode voltage range includes ground and the output voltage can also swing to ground, even though operated from only a single power supply voltage.

The gain-bandwidth product is temperature compensated.

**ORDER CODES**

Part Number	Temperature Range	Package			
		H	N	J	D
LM158/A	-55°C, +125°C	•	•	•	•
LM258/A	-40°C, +105°C	•	•	•	•
LM358/A	0°C, +70°C	•	•	•	•
LM2904	-40°C, +105°C	•	•	•	•

Examples : LM158H, LM258N, LM2904D

**PIN CONNECTIONS (top views)**

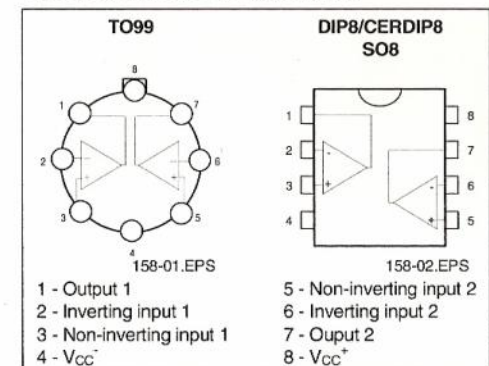

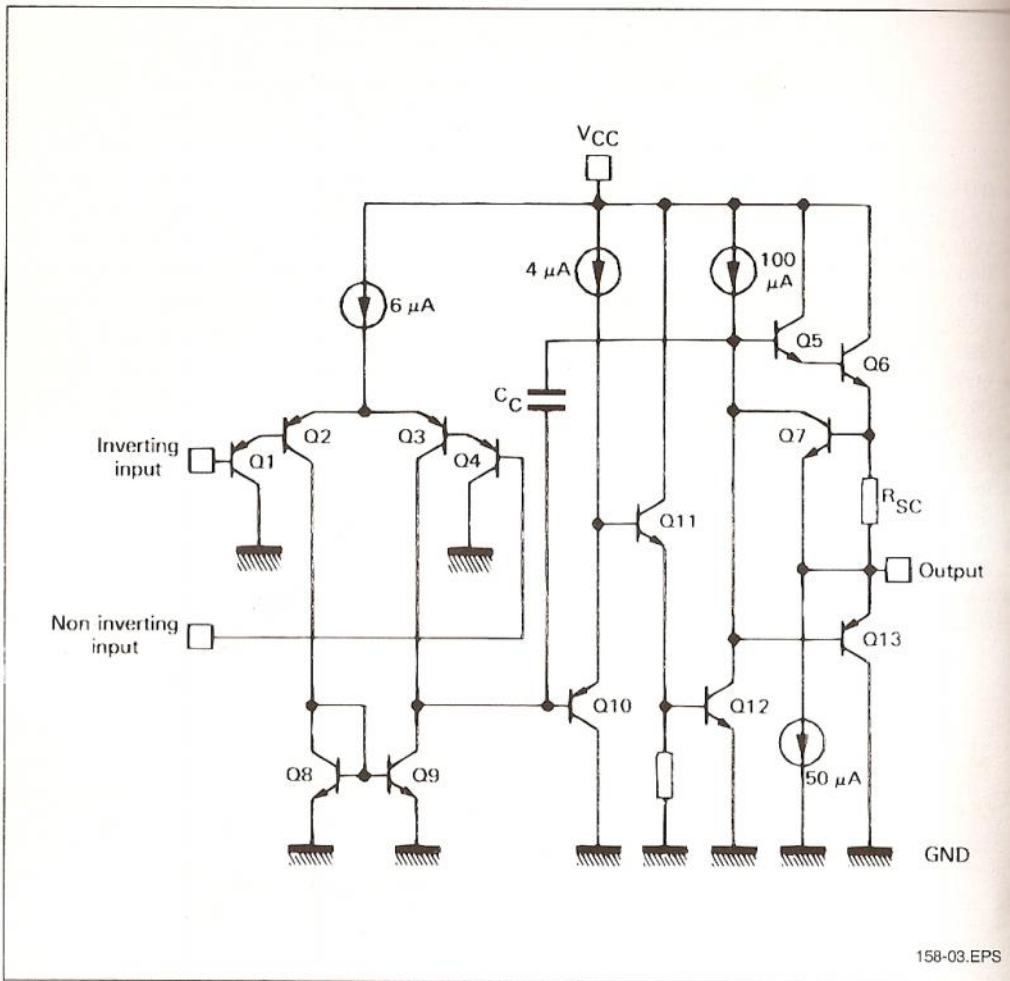

ABSOLUTE MAXIMUM RATINGS

Symbol	Parameter	LM158,A	LM258,A LM2904	LM358,A	Unit
V <sub>CC</sub>	Supply Voltage	+32	+32	+32	V
V <sub>i</sub>	Input Voltage	-0.3 to +32	-0.3 to +32	-0.3 to +32	V
V <sub>id</sub>	Differential Input Voltage	+32	+32	+32	V
	Output Short-circuit Duration - (note 2)	Infinite			
P <sub>tot</sub>	Power Dissipation	500	500	500	mW
I <sub>in</sub>	Input Current - (note 1)	50	50	50	mA
T <sub>oper</sub>	Operating Free-air Temperature Range	-55 to +125	-40 to +105	0 to +70	°C
T <sub>stg</sub>	Storage Temperature Range	-65 to +150	-65 to +150	-65 to +150	°C

ELECTRICAL CHARACTERISTICS

V<sub>CC</sub><sup>+</sup> = +5V, V<sub>CC</sub><sup>-</sup> = Ground, V<sub>O</sub> = 1.4V, T<sub>amb</sub> = 25°C (unless otherwise specified)

Symbol	Parameter	LM158A LM258A LM358A			LM158 - LM258 LM358 - LM2904			Unit
		Min.	Typ.	Max.	Min.	Typ.	Max.	
V <sub>io</sub>	Input Offset Voltage - (note 3) T <sub>amb</sub> = 25°C LM158, LM258 LM158A T <sub>min.</sub> ≤ T <sub>amb</sub> ≤ T <sub>max.</sub> LM158, LM258		1	3	2	7	5	mV
I <sub>io</sub>	Input Offset Current T <sub>amb</sub> = 25°C T <sub>min.</sub> ≤ T <sub>amb</sub> ≤ T <sub>max.</sub>		2	10	2	30	40	nA
I <sub>ib</sub>	Input Bias Current - (note 4) T <sub>amb</sub> = 25°C T <sub>min.</sub> ≤ T <sub>amb</sub> ≤ T <sub>max.</sub>		20	50	20	150	200	nA
A <sub>vd</sub>	Large Signal Voltage Gain (V <sub>CC</sub> <sup>+</sup> = +15V, R <sub>L</sub> = 2kΩ, V <sub>O</sub> = 1.4V to 11.4V) T <sub>amb</sub> = 25°C T <sub>min.</sub> ≤ T <sub>amb</sub> ≤ T <sub>max.</sub>	50	100		50	100		V/mV
SVR	Supply Voltage Rejection Ratio (R <sub>S</sub> = 10kΩ) (V <sub>CC</sub> <sup>+</sup> = 5 to 30V) T <sub>amb</sub> = 25°C T <sub>min.</sub> ≤ T <sub>amb</sub> ≤ T <sub>max.</sub>	65	100		65	100		dB
I <sub>CC</sub>	Supply Current, all Amp, no Load V <sub>CC</sub> = +5V, T <sub>min.</sub> ≤ T <sub>amb</sub> ≤ T <sub>max.</sub> V <sub>CC</sub> = +30V, T <sub>min.</sub> ≤ T <sub>amb</sub> ≤ T <sub>max.</sub>		0.7	1.2	0.7	1.2	2	mA
V <sub>icm</sub>	Input Common Mode Voltage Range (V <sub>CC</sub> = +30V) - (note 6) T <sub>amb</sub> = 25°C T <sub>min.</sub> ≤ T <sub>amb</sub> ≤ T <sub>max.</sub>	0		V <sub>CC</sub> <sup>+</sup> -1.5 V <sub>CC</sub> <sup>+</sup> -2	0		V <sub>CC</sub> <sup>+</sup> -1.5 V <sub>CC</sub> <sup>+</sup> -2	V
CMR	Common-mode Rejection Ratio (R <sub>S</sub> = 10kΩ) T <sub>amb</sub> = 25°C T <sub>min.</sub> ≤ T <sub>amb</sub> ≤ T <sub>max.</sub>	70	85		70	85		dB
I <sub>O</sub>	Output Short Circuit Current (V <sub>CC</sub> = +15V, V <sub>O</sub> = 2V, V <sub>id</sub> = +1V)	20	40	60	20	40	60	mA
I <sub>sink</sub>	Output Current Sink (V <sub>id</sub> = -1V) V <sub>CC</sub> = +15V, V <sub>O</sub> = 2V V <sub>CC</sub> = +15V, V <sub>O</sub> = +0.2V	10	20		10	20		mA μA
V <sub>OPP</sub>	Output Voltage Swing (R <sub>L</sub> = 2kΩ) T <sub>amb</sub> = 25°C T <sub>min.</sub> ≤ T <sub>amb</sub> ≤ T <sub>max.</sub>	0		V <sub>CC</sub> <sup>+</sup> -1.5 V <sub>CC</sub> <sup>+</sup> -2	0		V <sub>CC</sub> <sup>+</sup> -1.5 V <sub>CC</sub> <sup>+</sup> -2	V
V <sub>OH</sub>	High Level Output Voltage (V <sub>CC</sub> <sup>+</sup> = 30V) T <sub>amb</sub> = 25°C T <sub>min.</sub> ≤ T <sub>amb</sub> ≤ T <sub>max.</sub> R <sub>L</sub> = 2kΩ T <sub>amb</sub> = 25°C T <sub>min.</sub> ≤ T <sub>amb</sub> ≤ T <sub>max.</sub> R <sub>L</sub> = 10kΩ	26	27		26	27		V
V <sub>OL</sub>	Low Level Output Voltage (R <sub>L</sub> = 10kΩ) T <sub>amb</sub> = 25°C T <sub>min.</sub> ≤ T <sub>amb</sub> ≤ T <sub>max.</sub>		5	20	5	20	20	mV
SR	Slew Rate (V <sub>CC</sub> = 15V, V <sub>i</sub> = 0.5 to 3V, R <sub>L</sub> = 2kΩ, C <sub>L</sub> = 100pF, T <sub>amb</sub> = 25°C, unity gain)	0.3	0.6		0.3	0.6		V/μs

ELECTRICAL CHARACTERISTICS (continued)

Symbol	Parameter	LM158A LM258A LM358A			LM158 - LM258 LM358 - LM2904			Unit
		Min.	Typ.	Max.	Min.	Typ.	Max.	
GBP	Gain Bandwidth Product ( $V_{CC} = 30V, f = 100kHz, T_{amb} = 25^{\circ}C,$ $V_{in} = 10mV, R_L = 2k\Omega, C_L = 100pF$ )	0.7	1.1		0.7	1.1		MHz
THD	Total Harmonic Distortion ( $f = 1kHz, A_v = 20dB, R_L = 2k\Omega, V_{CC} = 30V,$ $C_L = 100pF, T_{amb} = 25^{\circ}C, V_O = 2 PP$ )		0.02			0.02		%
$e_n$	Equivalent Input Noise voltage ( $f = 1kHz, R_s = 100\Omega, V_{CC} = 30V$ )		55			55		$\frac{nV}{\sqrt{Hz}}$
$DV_{io}$	Input Offset Voltage Drift		7	15		7	30	$\mu V/^{\circ}C$
$DI_{io}$	Input Offset Current Drift		10	200		10	300	$pA/^{\circ}C$
$V_{O1}/V_{O2}$	Channel Separation (note 5) $1kHz \leq f \leq 20kHz$		120			120		dB

- Notes :
- This input current only exist when the voltage at any of the input leads is driven negative. It is due to the collector-base junction of the input PNP transistor becoming forward biased and thereby acting as input diode clamps. In addition to this diode action, there is also NPN parasitic action on the IC chip. This transistor action can cause the output voltages of the Op-amps to go to the  $V_{CC}$  voltage level (or to ground for a large overdrive) for the time duration that an input is driven negative. This is not destructive and normal output will set up again for input voltage higher than  $-0.3V$ .
  - Short-circuits from the output to  $V_{CC}$  can cause excessive heating if  $V_{CC} > 15V$ . The maximum output current is approximately 40mA independent of the magnitude of  $V_{CC}$ . Destructive dissipation can result from simultaneous short-circuits on all amplifiers.
  - $V_O = 1.4V, R_s = 0\Omega, 5V < V_{CC} < 30V, 0 < V_{ic} < V_{CC} - 1.5V$ .
  - The direction of the input current is out of the IC. This current is essentially constant, independent of the state of the output so no loading change exists on the input lines.
  - Due to the proximity of external components insure that coupling is not originating via stray capacitance between these external parts. This typically can be detected as this type of capacitance increases at higher frequencies.
  - The input common-mode voltage of either input signal voltage should not be allowed to go negative by more than 0.3V. The upper end of the common-mode voltage range is  $V_{CC} - 1.5V$ . But either or both inputs can go to +32V without damage.

OPEN LOOP FREQUENCY RESPONSE (Note 3)

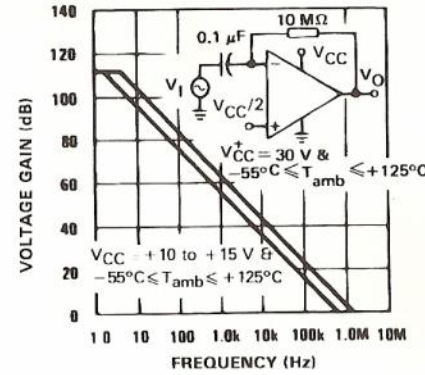

LARGE SIGNAL FREQUENCY RESPONSE

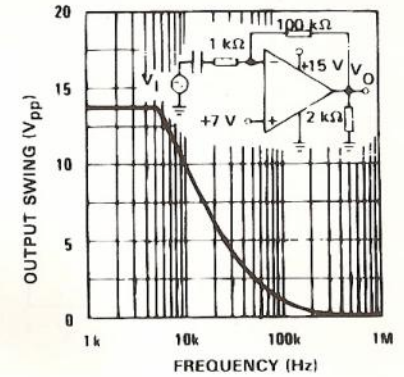

VOLTAGE FOLLOWER PULSE RESPONSE

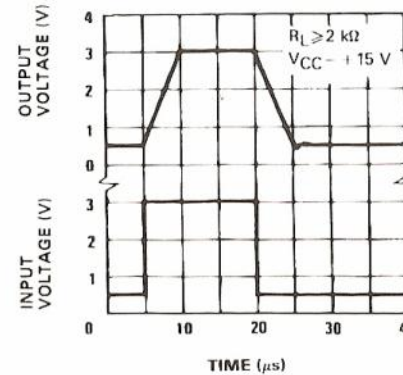

OUTPUT CHARACTERISTICS

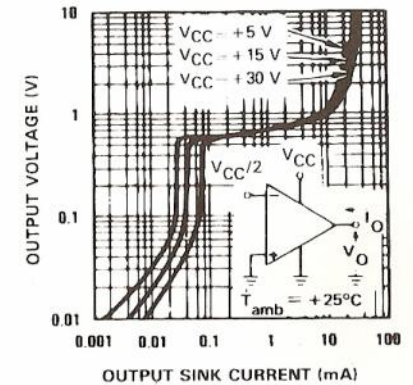

158-04.EPS

COMMON-MODE REJECTION RATIO

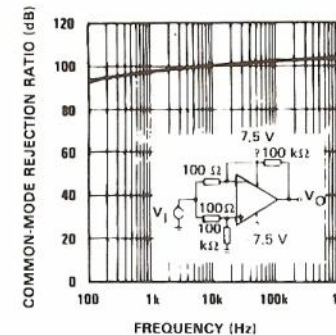

158-05.EPS

VOLTAGE FOLLOWER PULSE RESPONSE (SMALL SIGNAL)

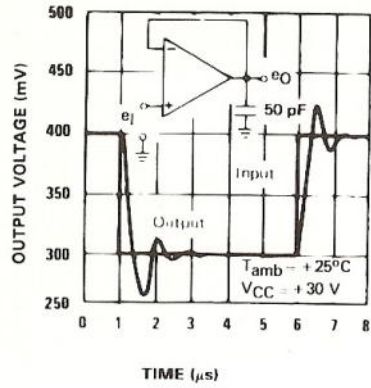

OUTPUT CHARACTERISTICS

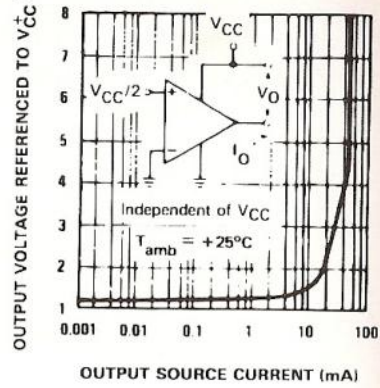

VOLTAGE GAIN

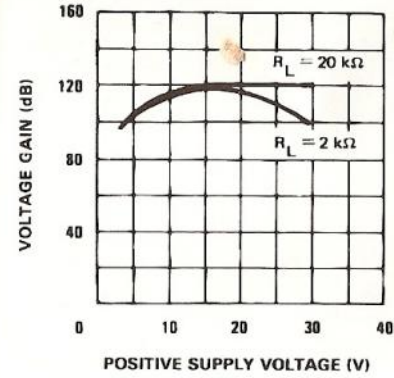

158-07.EPS

INPUT CURRENT

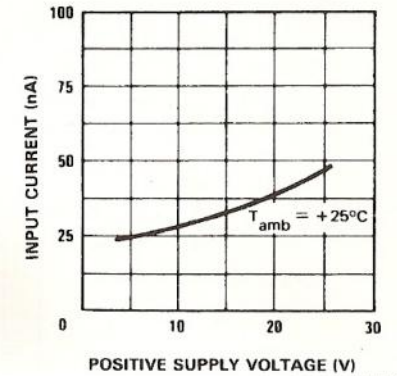

158-08.EPS

INPUT CURRENT (Note 1)

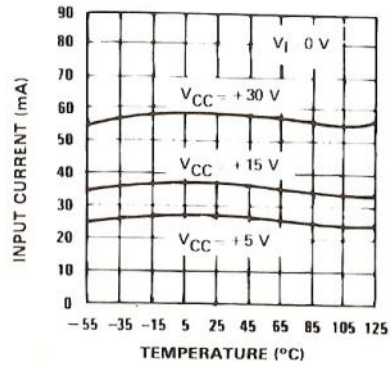

CURRENT LIMITING (Note 1)

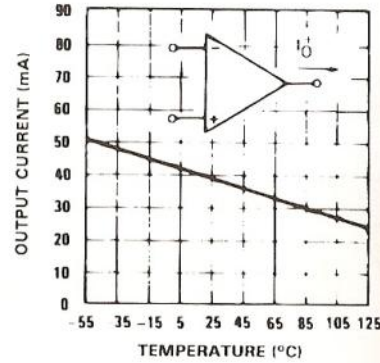

VOLTAGE GAIN

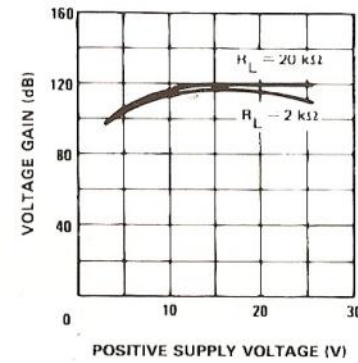

158-09.EPS

GAIN BANDWIDTH PRODUCT

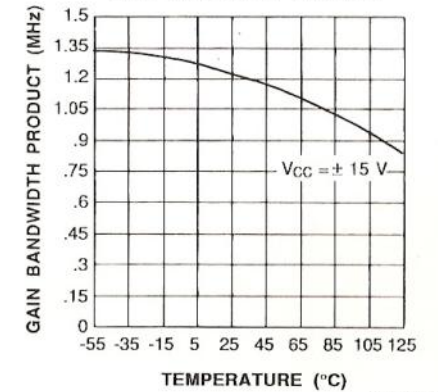

158-10.EPS

INPUT VOLTAGE RANGE

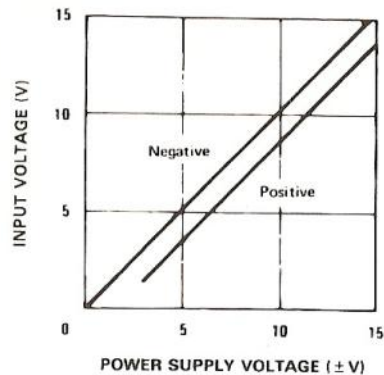

SUPPLY CURRENT

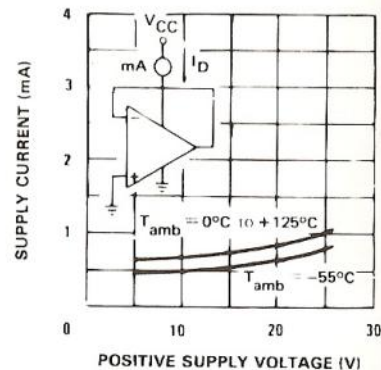

158-06.EPS

POWER SUPPLY REJECTION RATIO

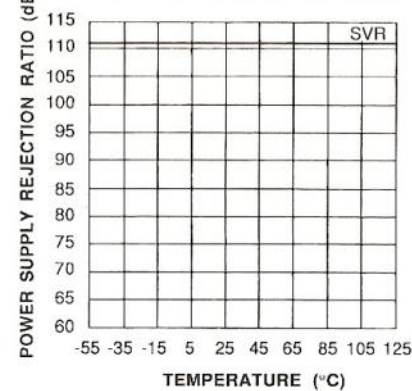

158-11.EPS

COMMON MODE REJECTION RATIO

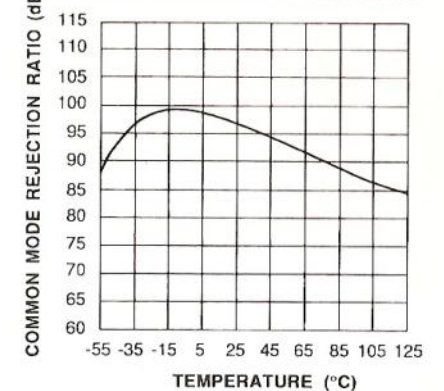

158-12.EPS