

SoniCrest

PIEZO SOUND GENERATORS



HPA29AX

Dimension

Unit : mm
Tolerance : ±0.3mm

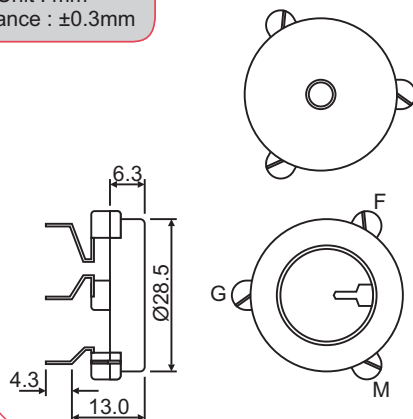

Characteristics Response

Measuring Temperature : 25°C
Measuring Distance : 30cm

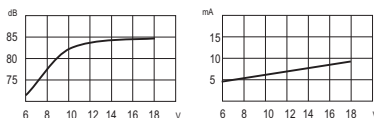

Specification (all data taken at 25°C unless otherwise specified)

HPA29AX	Rated Voltage (VDC)	Operating Voltage (VDC)	★Rated Current (mA)	★Sound Output at 30cm (dB)	★Generated Frequency (Hz)	Operating Temperature (°C)	Storage Temperature (°C)
	12	3 ~ 28	≤ 8	≥ 80	3000 ± 500	-20 ~ +60	-30 ~ +70

★Value Applying Rated Voltage, DC