

PLEASE CHECK WWW.MOLEX.COM FOR LATEST PART INFORMATION

Part Number: [0675810002](#)
Status: **Active**
Overview: [serial_ata_products](#)
Description: 1.27mm (.050") Pitch Serial ATA Crimp Terminal for Power Cable Receptacle, 0.38µm (15µ") Gold (Au) Plating, with Reel Direction - Type 1, Lead free

Documents:

[3D Model](#) [Product Specification PS-67490-002 \(PDF\)](#)
[Drawing \(PDF\)](#) [RoHS Certificate of Compliance \(PDF\)](#)

General

Product Family	Crimp Terminals
Series	67581
Crimp Quality Equipment	Yes
Overview	serial_ata_products
Product Name	Serial ATA

Physical

Durability (mating cycles max)	50
Gender	Female
Material - Metal	Phosphor Bronze
Material - Plating Mating	Gold
Material - Plating Termination	Tin
Packaging Type	Reel
Plating min: Mating (µin)	15
Plating min: Mating (µm)	0.38
Plating min: Termination (µin)	73.82
Plating min: Termination (µm)	1.85
Termination Interface: Style	Crimp or Compression
Wire Insulation Diameter	2.20-1.60mm(0.087-0.063)
Wire Size AWG	18, 20, 22
Wire Size mm²	3.79-2.00

Electrical

Current - Maximum per Contact	1.5A
Voltage - Maximum	15V DC

Solder Process Data

Lead-free Process Capability	Wave Capable (TH only)
------------------------------	------------------------

Material Info

Reference - Drawing Numbers

Packaging Specification	PK-67581-001
Product Specification	PS-67490-002
Sales Drawing	SD-67581-001

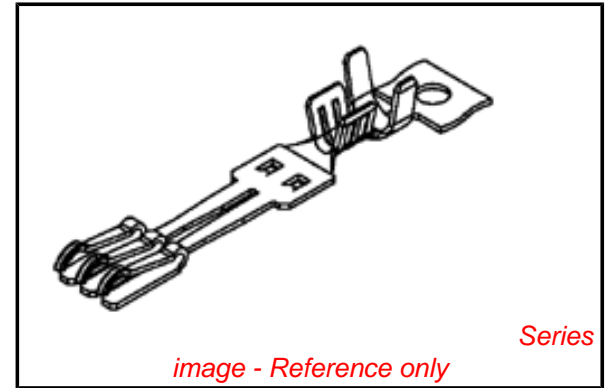

image - Reference only

EU RoHS

**ELV and RoHS
Compliant**
REACH SVHC
 Not Reviewed
**Halogen-Free
Status**

China RoHS



**Need more information on product
environmental compliance?**

Email productcompliance@molex.com
 For a multiple part number RoHS Certificate of Compliance, [click here](#)

Please visit the [Contact Us](#) section for any non-product compliance questions.

Search Parts in this Series

[67581Series](#)

Use With

[67582 Crimp Housing](#)

10 9 8 7 6 5 4 3 2 1

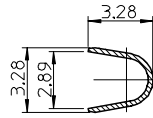
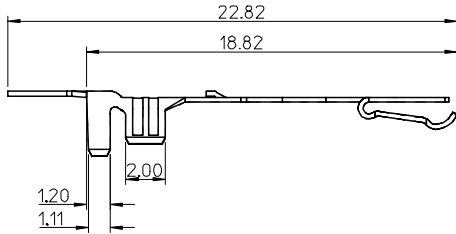

Section I-I

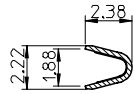

Section C-C

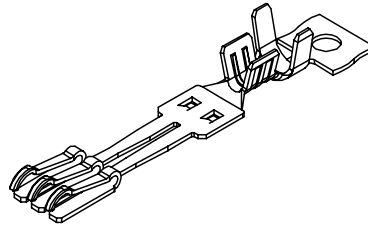
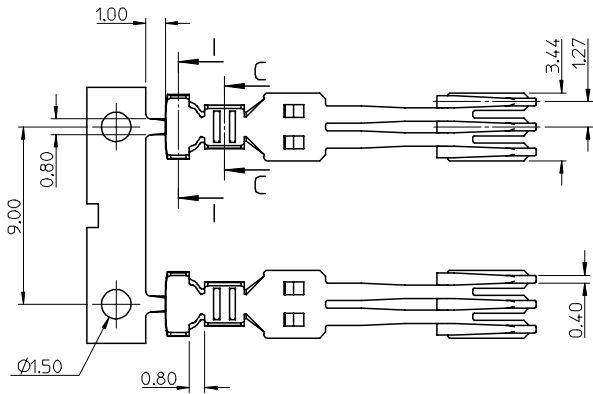

NOTES:

- MATERIAL :
PHOSPHOR BRONZE, THICKNESS = 0.25mm
- PLATING :
CONTACT AREA: (A) GOLD FLASH
(B) GOLD PLATED 0.76 MICRON.
(C) GOLD PLATED 0.38 MICRON.
CRIMPING AREA: TIN PLATED 1.875 MICRON MINIMUM.
UNDER PLATE: NICKELPLATED 1.25 MICRON MINIMUM.
- TO BE USED WITH 67582, 5 SETS TERMINAL PER HOUSING
- PRODUCT SPECIFICATION REFER TO PS-67490-002
- PACKAGE SPECIFICATION REFER TO PK-67581-001
- CRIMPING SPECIFICATION REFER TO CS-67581-001
- RECOMMEND WIRE SIZE: 18/20/22AWG
- PRODUCT COMPLIANT TO RoHS DIRECTIVE 2002/95/EC AND ELV DIRECTIVE 2000/53/EC.

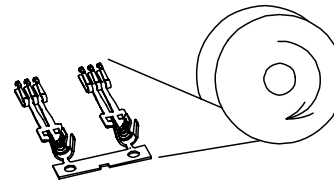

BEFORE CRIMPING
TYPE I

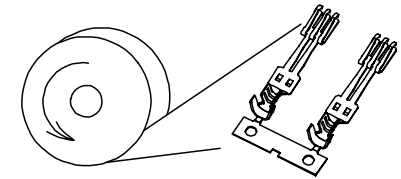

BEFORE CRIMPING
TYPE II

P/N	CONTACT AREA GOLD PLATING	TYPE
67581-0000	GOLD FLASH	TYPE I
67581-0001	0.76 MICRON GOLD PLATING	
67581-0002	0.38 MICRON GOLD PLATING	
67581-0010	GOLD FLASH	TYPE II
67581-0011	0.76 MICRON GOLD PLATING	
67581-0012	0.38 MICRON GOLD PLATING	

NEW RELEASE EC NO: SH2007-0312 DRWN: BCHENZ6 CHKD: JTIAN APPR: JNCHEN	2006/11/01 2006/11/03 2006/11/07	QUALITY SYMBOLS	GENERAL TOLERANCES (UNLESS SPECIFIED)	DIMENSION STYLE	SCALE	DESIGN UNITS	THIRD ANGLE PROJECTION
		▽=0 ▽=0	mm INCH 4 PLACES ± --- ± --- 3 PLACES ± --- ± --- 2 PLACES ± 0.25 ± .010 1 PLACE ± 0.25 ± .010 ANGULAR ± 3 °	MM ONLY	4:1	METRIC	DRAWN BY DATE GRATE MA 2003/08/15 CHECKED BY DATE YA JUN 2003/08/15 APPROVED BY DATE SAM 2003/08/15
		DESCRIPTION	TITLE	TERMINAL FOR SATA POWER CABLE RECEPTACLE			
		DRAFT WHERE APPLICABLE MUST REMAIN WITHIN DIMENSIONS	MATERIAL NO. SEE TABLE	DOCUMENT NO. SD-67581-001	MOLEX INCORPORATED		
REV	SIZE	THIS DRAWING CONTAINS INFORMATION THAT IS PROPRIETARY TO MOLEX INCORPORATED AND SHOULD NOT BE USED WITHOUT WRITTEN PERMISSION					

9 8 7 6 5 4 3 2 1