

PLEASE CHECK WWW.MOLEX.COM FOR LATEST PART INFORMATION

Part Number: [0459846482](#)
Status: **Active**
Overview: extreme_lphpower
Description: 1.27mm (.050"), 12.00mm (.472") Pitch, EXTreme LPHPower™ Receptacle Header, Right Angle, 6 Power Contacts, 40 Signal Contacts, Select Gold (Au) Plating, for 2.36mm (.093") Thick PC Board, with Guide Posts, with Press-fit Plastic Pegs

Documents:

[3D Model](#) [Product Specification PS-45984-001 \(PDF\)](#)
[Drawing \(PDF\)](#) [RoHS Certificate of Compliance \(PDF\)](#)

Agency Certification

CSA LR19980
 UL E29179

General

Product Family PCB Receptacles
 Series [45984](#)
 Application Board-to-Board
 Overview extreme_lphpower
 Product Name EXTreme LPHPower™

Physical

Circuits (Loaded) 46
 Circuits (maximum) 46
 Circuits Detail 6 Power, 40 Signal
 Color - Resin Black
 Durability (mating cycles max) 250
 Flammability 94V-0
 Glow-Wire Compliant No
 Guide to Mating Part Yes
 Keying to Mating Part Yes
 Lock to Mating Part No
 Material - Metal High Performance Alloy (HPA), Phosphor Bronze
 Material - Plating Mating Gold
 Material - Plating Termination Tin
 Material - Resin High Temperature Thermoplastic
 Number of Rows 2
 Orientation Right Angle
 PC Tail Length (in) 0.142 In
 PC Tail Length (mm) 3.60 mm
 PCB Locator Yes
 PCB Retention Yes
 PCB Thickness Recommended (in) 0.093 In
 PCB Thickness Recommended (mm) 2.36 mm
 Packaging Type Tray
 Pitch - Mating Interface (in) 0.050 In, 0.472 In
 Pitch - Mating Interface (mm) 1.27 mm, 12.00 mm
 Plating min: Mating (µin) 30
 Plating min: Mating (µm) 0.75
 Plating min: Termination (µin) 150, 75
 Plating min: Termination (µm) 1.875, 3.75
 Polarized to Mating Part Yes
 Polarized to PCB Yes
 Stackable No
 Surface Mount Compatible (SMC) Yes

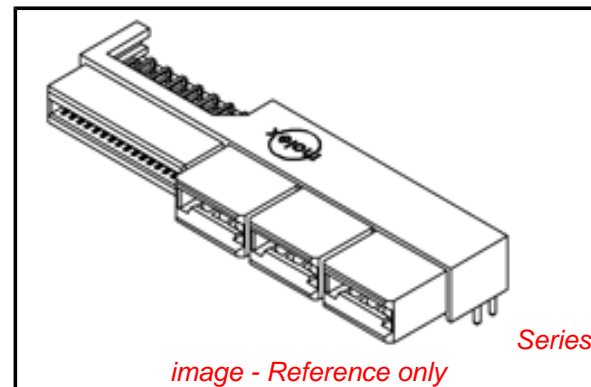

image - Reference only

EU RoHS

ELV and RoHS Compliant
REACH SVHC Contains SVHC: No
Halogen-Free Status

China RoHS



Need more information on product environmental compliance?

Email productcompliance@molex.com
 For a multiple part number RoHS Certificate of Compliance, [click here](#)

Please visit the [Contact Us](#) section for any non-product compliance questions.

Search Parts in this Series

[45984Series](#)

Mates With

[45985](#) EXTreme LPHPower™ Headers, 1.57mm (.062") Card Edge

Temperature Range - Operating -40°C to +105°C
Termination Interface: Style Through Hole

Electrical

Current - Maximum per Contact 27A
Grounding to PCB No
Voltage - Maximum 250V AC (RMS)/DC

Solder Process Data

Duration at Max. Process Temperature (seconds) 20
Lead-free Process Capability Wave Capable (TH only)
Max. Cycles at Max. Process Temperature 3
Process Temperature max. C 260

Material Info

Reference - Drawing Numbers

Packaging Specification PK-45984-001
Product Specification PS-45984-001
Sales Drawing SD-45984-600

This document was generated on 05/21/2010

PLEASE CHECK WWW.MOLEX.COM FOR LATEST PART INFORMATION



- NOTES:
1. MATERIAL HOUSING: LCP, 94V-0, COLOR-BLACK.
CONTACT: COPPER ALLOY.
 2. FINISH: SELECT GOLD - .76µM/30 MI MIN. CONTACT AREA.
SELECT TIN - 3.81µM/150 MI MIN. TAIL AREA.
BOTH OVER NICKEL - 1.27µM/50 MI MIN.
 3. POWER TERMINALS LUBRICATED IN CONTACT AREA.
 4. PRODUCT SPECIFICATION: PS-45984-001.
 5. PACKAGING: TRAY PER PK-45984-001.
 6. SEE SHEET 5 FOR CKT IDENTIFICATION.
 7. PARTS ARE RoHS COMPLIANT.
 8. PEG HOLES ARE OPTIONAL - SEE SHEETS 3 & 4.
 9. MATES TO 1.57/.062 CARD EDGE OR MOLEX P/N 45985-6***.

| NO OF SIGNAL | MATERIAL NUMBER | DIM A | DIM P | PCB THK |
|--------------|-----------------|-------|-------|---------|
| 12 | 45984-6111 | 47.5 | 4.50 | 3.18 |
| 16 | 45984-6121 | 50.0 | | |
| 20 | 45984-6131 | 52.6 | | |
| 24 | 45984-6141 | 55.1 | | |
| 28 | 45984-6151 | 57.6 | | |
| 32 | 45984-6161 | 60.2 | 3.60 | 2.36 |
| 36 | 45984-6171 | 62.7 | | |
| 40 | 45984-6181 | 65.3 | | |
| 12 | 45984-6112 | 47.5 | | |
| 16 | 45984-6122 | 50.0 | | |
| 20 | 45984-6132 | 52.6 | 2.90 | 1.57 |
| 24 | 45984-6142 | 55.1 | | |
| 28 | 45984-6152 | 57.6 | | |
| 32 | 45984-6162 | 60.2 | | |
| 36 | 45984-6172 | 62.7 | | |
| 40 | 45984-6182 | 65.3 | | |
| 12 | 45984-6113 | 47.5 | 2.90 | 1.57 |
| 16 | 45984-6123 | 50.0 | | |
| 20 | 45984-6133 | 52.6 | | |
| 24 | 45984-6143 | 55.1 | | |
| 28 | 45984-6153 | 57.6 | | |
| 32 | 45984-6163 | 60.2 | 2.90 | 1.57 |
| 36 | 45984-6173 | 62.7 | | |
| 40 | 45984-6183 | 65.3 | | |

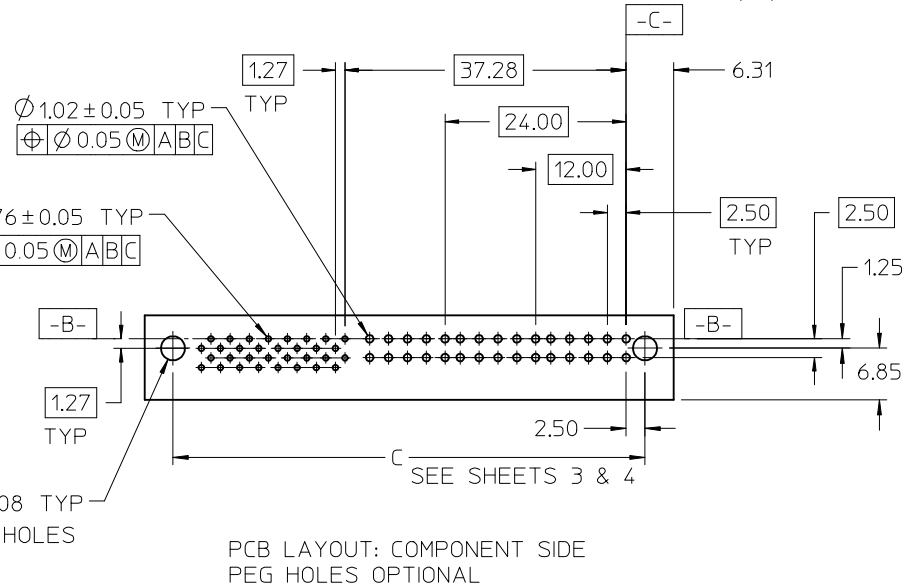
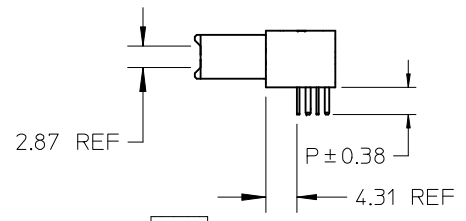
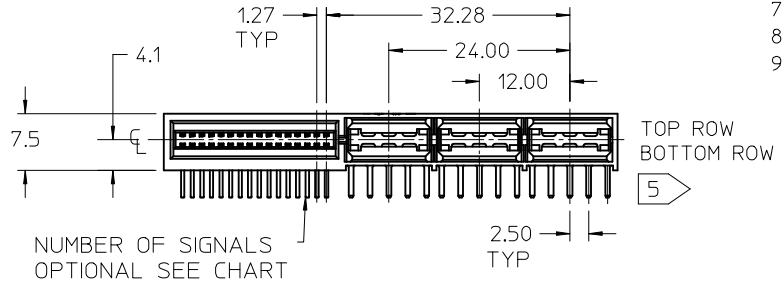

PCB LAYOUT: COMPONENT SIDE
PEG HOLES OPTIONAL

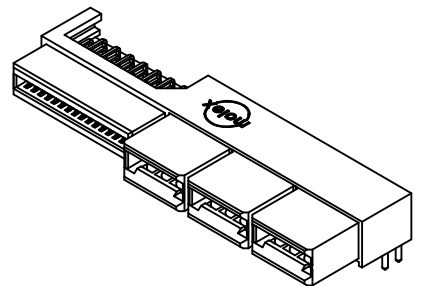

| | | | | |
|---------------|---------------------|-------------|-------------|------------|
| REVISED | EC NO: UCP2009-0971 | 2008/11/13 | 2008/11/14 | 2008/11/17 |
| DRWN:MBANDURA | CHKD: | APPR:APATEL | DESCRIPTION | REV |

| | |
|--|--------------|
| GENERAL TOLERANCES (UNLESS SPECIFIED) | |
| | mm INCH |
| 4 PLACES | ± --- ± --- |
| 3 PLACES | ± --- ± --- |
| 2 PLACES | ± 0.25 ± --- |
| 1 PLACE | ± --- ± --- |
| ANGULAR ± 1/2° | |
| DRAFT WHERE APPLICABLE MUST REMAIN WITHIN DIMENSIONS | |

| | |
|-----------------|------------|
| DIMENSION STYLE | |
| MM ONLY | |
| DRAWN BY | DATE |
| SAMIEC | 2005/05/13 |
| CHECKED BY | DATE |
| SAMIEC | 2005/05/13 |
| APPROVED BY | DATE |
| MARGULIS | 2005/05/13 |
| MATERIAL NO. | |

| | | |
|---|--------------|------------------------|
| SCALE | DESIGN UNITS | THIRD ANGLE PROJECTION |
| 1:1 | METRIC | |
| TITLE | | |
| LPH RECEPTACLE ASSEMBLY RT ANGLE 6 CIRCUIT POWER CONNECTOR | | |
| MOLEX INCORPORATED | | |
| DOCUMENT NO. | SHEET NO. | |
| SD-45984-600 | 1 OF 5 | |
| THIS DRAWING CONTAINS INFORMATION THAT IS PROPRIETARY TO MOLEX INCORPORATED AND SHOULD NOT BE USED WITHOUT WRITTEN PERMISSION | | |

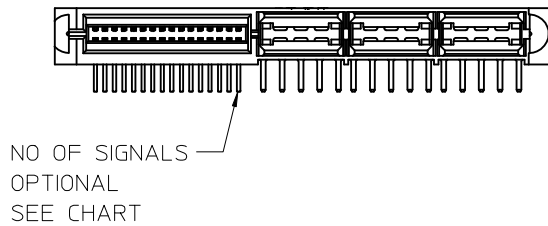
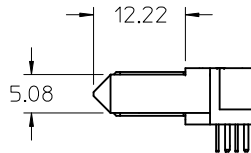
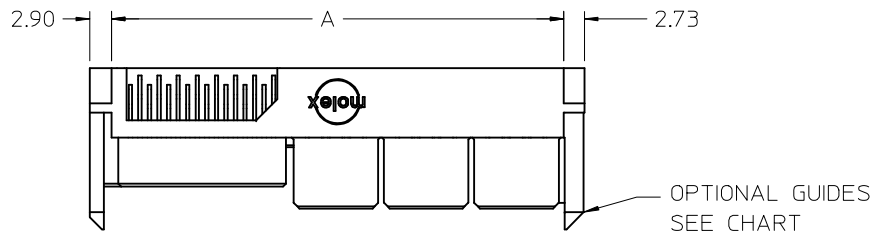

GUIDE POST OPTIONS

| NO OF SIGNAL | MATERIAL NUMBER | DIM A | DIM P | PCB THK |
|--------------|-----------------|-------|-------|---------|
| 12 | 45984-6211 | 47.5 | 4.50 | 3.18 |
| 16 | 45984-6221 | 50.0 | | |
| 20 | 45984-6231 | 52.6 | | |
| 24 | 45984-6241 | 55.1 | | |
| 28 | 45984-6251 | 57.6 | | |
| 32 | 45984-6261 | 60.2 | | |
| 36 | 45984-6271 | 62.7 | 3.60 | 2.36 |
| 40 | 45984-6281 | 65.3 | | |
| 12 | 45984-6212 | 47.5 | | |
| 16 | 45984-6222 | 50.0 | | |
| 20 | 45984-6232 | 52.6 | | |
| 24 | 45984-6242 | 55.1 | | |
| 28 | 45984-6252 | 57.6 | 2.90 | 1.57 |
| 32 | 45984-6262 | 60.2 | | |
| 36 | 45984-6272 | 62.7 | | |
| 40 | 45984-6282 | 65.3 | | |
| 12 | 45984-6213 | 47.5 | | |
| 16 | 45984-6223 | 50.0 | | |
| 20 | 45984-6233 | 52.6 | | |
| 24 | 45984-6243 | 55.1 | | |
| 28 | 45984-6253 | 57.6 | | |
| 32 | 45984-6263 | 60.2 | | |
| 36 | 45984-6273 | 62.7 | | |
| 40 | 45984-6283 | 65.3 | | |

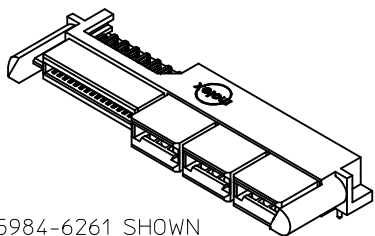

45984-6261 SHOWN FOR REF ONLY SEE CHART

| | |
|--------------------------|-------------|
| REVISED | DESCRIPTION |
| EC NO: UCP2009-0971 | |
| DRWN:MBANDURA 2008/11/13 | |
| CHKD: 2008/11/14 | |
| APPR:APATEL 2008/11/17 | |
| REV | |

GENERAL TOLERANCES (UNLESS SPECIFIED)

| | mm | INCH |
|---------------|--------|-------|
| 4 PLACES | ± --- | ± --- |
| 3 PLACES | ± --- | ± --- |
| 2 PLACES | ± 0.25 | ± --- |
| 1 PLACE | ± --- | ± --- |
| ANGULAR ±1/2° | | |

DRAFT WHERE APPLICABLE MUST REMAIN WITHIN DIMENSIONS

DIMENSION STYLE
MM ONLY

| | |
|--------------|------------|
| DRAWN BY | DATE |
| SAMIEC | 2005/05/13 |
| CHECKED BY | DATE |
| SAMIEC | 2005/05/13 |
| APPROVED BY | DATE |
| MARGULIS | 2005/05/13 |
| MATERIAL NO. | |

SIZE
A

THIS DRAWING CONTAINS INFORMATION THAT IS PROPRIETARY TO MOLEX INCORPORATED AND SHOULD NOT BE USED WITHOUT WRITTEN PERMISSION

SCALE
1:1

DESIGN UNITS
METRIC

THIRD ANGLE PROJECTION

TITLE
LPH RECEPTACLE ASSEMBLY
RT ANGLE 6 CIRCUIT
POWER CONNECTOR

MOLEX MOLEX INCORPORATED

DOCUMENT NO. SD-45984-600 SHEET NO. 2 OF 5

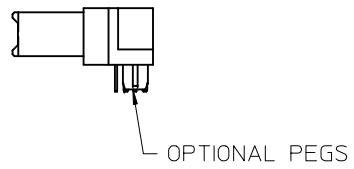
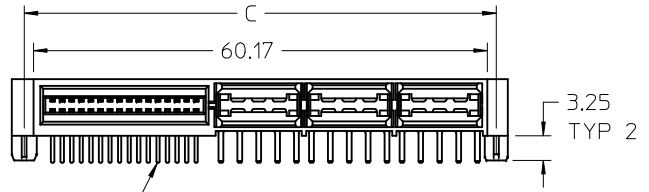
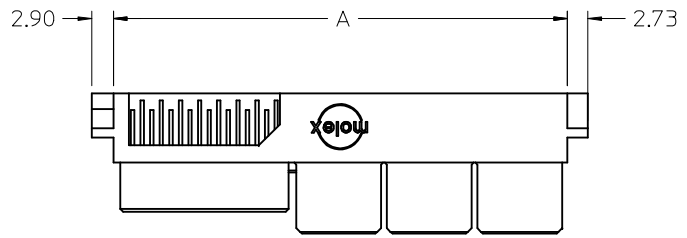

NO OF SIGNALS
OPTIONAL
SEE CHART

MOUNTING PEG OPTIONS

| NO OF SIGNAL | MATERIAL NUMBER | DIM A | DIM C | DIM P | PCB THK |
|--------------|-----------------|-------|-------|-------|---------|
| 12 | 45984-6311 | 47.5 | 49.90 | 4.50 | 3.18 |
| 16 | 45984-6321 | 50.0 | 52.44 | | |
| 20 | 45984-6331 | 52.6 | 54.98 | | |
| 24 | 45984-6341 | 55.1 | 57.52 | | |
| 28 | 45984-6351 | 57.6 | 60.06 | | |
| 32 | 45984-6361 | 60.2 | 62.60 | | |
| 36 | 45984-6371 | 62.7 | 65.14 | 3.60 | 2.36 |
| 40 | 45984-6381 | 65.3 | 67.68 | | |
| 12 | 45984-6312 | 47.5 | 49.90 | | |
| 16 | 45984-6322 | 50.0 | 52.44 | | |
| 20 | 45984-6332 | 52.6 | 54.98 | | |
| 24 | 45984-6342 | 55.1 | 57.52 | | |
| 28 | 45984-6352 | 57.6 | 60.06 | 2.90 | 1.57 |
| 32 | 45984-6362 | 60.2 | 62.60 | | |
| 36 | 45984-6372 | 62.7 | 65.14 | | |
| 40 | 45984-6382 | 65.3 | 67.68 | | |
| 12 | 45984-6313 | 47.5 | 49.90 | | |
| 16 | 45984-6323 | 50.0 | 52.44 | | |
| 20 | 45984-6333 | 52.6 | 54.98 | | |
| 24 | 45984-6343 | 55.1 | 57.52 | | |
| 28 | 45984-6353 | 57.6 | 60.06 | | |
| 32 | 45984-6363 | 60.2 | 62.60 | | |
| 36 | 45984-6373 | 62.7 | 65.14 | | |
| 40 | 45984-6383 | 65.3 | 67.68 | | |

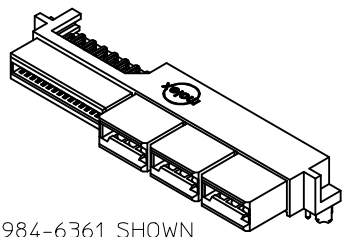

45984-6361 SHOWN
FOR REF ONLY
SEE CHART

| | | | | | |
|---------|---------------------|---------------|-------|-------------|-------------|
| REVISED | EC NO: UCP2009-0971 | DRWN:MBANDURA | CHKD: | APPR:APATEL | DESCRIPTION |
| | 2008/11/13 | 2008/11/14 | | 2008/11/17 | |
| REV | | | | | |

| | | |
|--|--------|-------|
| GENERAL TOLERANCES (UNLESS SPECIFIED) | | |
| | mm | INCH |
| 4 PLACES | ± --- | ± --- |
| 3 PLACES | ± --- | ± --- |
| 2 PLACES | ± 0.25 | ± --- |
| 1 PLACE | ± --- | ± --- |
| ANGULAR ±1/2° | | |
| DRAFT WHERE APPLICABLE MUST REMAIN WITHIN DIMENSIONS | | |

| | |
|-----------------|------------|
| DIMENSION STYLE | |
| MM ONLY | |
| DRAWN BY | DATE |
| SAMIEC | 2005/05/13 |
| CHECKED BY | DATE |
| SAMIEC | 2005/05/13 |
| APPROVED BY | DATE |
| MARGULIS | 2005/05/13 |
| MATERIAL NO. | |

| | | |
|---|--------------|------------------------|
| SCALE | DESIGN UNITS | THIRD ANGLE PROJECTION |
| 1:1 | METRIC | |
| TITLE | | |
| LPH RECEPTACLE ASSEMBLY RT ANGLE 6 CIRCUIT POWER CONNECTOR | | |
| MOLEX INCORPORATED | | |
| DOCUMENT NO. | SHEET NO. | |
| SD-45984-600 | 3 OF 5 | |
| THIS DRAWING CONTAINS INFORMATION THAT IS PROPRIETARY TO MOLEX INCORPORATED AND SHOULD NOT BE USED WITHOUT WRITTEN PERMISSION | | |

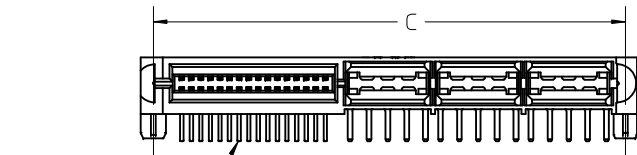
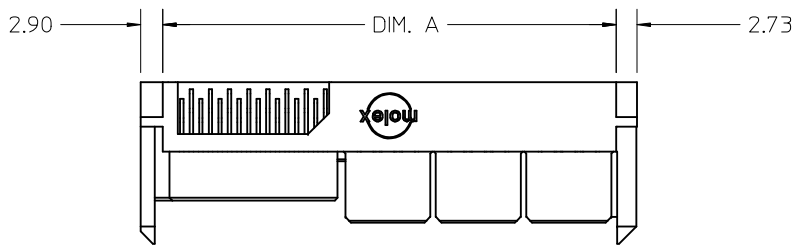

NO OF SIGNALS
OPTIONAL
SEE CHART

OPTIONAL GUIDES

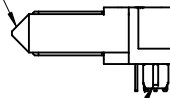

OPTIONAL PEGS

GUIDE POST & MOUNTING PEG OPTIONS

| NO OF SIGNAL | MATERIAL NUMBER | DIM A | DIM C | DIM P | PCB THK |
|--------------|-----------------|-------|-------|-------|---------|
| 12 | 45984-6411 | 47.5 | 49.90 | 4.50 | 3.18 |
| 16 | 45984-6421 | 50.0 | 52.44 | | |
| 20 | 45984-6431 | 52.6 | 54.98 | | |
| 24 | 45984-6441 | 55.1 | 57.52 | | |
| 28 | 45984-6451 | 57.6 | 60.06 | | |
| 32 | 45984-6461 | 60.2 | 62.60 | | |
| 36 | 45984-6471 | 62.7 | 65.14 | 3.60 | 2.36 |
| 40 | 45984-6481 | 65.3 | 67.68 | | |
| 12 | 45984-6412 | 47.5 | 49.90 | | |
| 16 | 45984-6422 | 50.0 | 52.44 | | |
| 20 | 45984-6432 | 52.6 | 54.98 | | |
| 24 | 45984-6442 | 55.1 | 57.52 | | |
| 28 | 45984-6452 | 57.6 | 60.06 | 2.90 | 1.57 |
| 32 | 45984-6462 | 60.2 | 62.60 | | |
| 36 | 45984-6472 | 62.7 | 65.14 | | |
| 40 | 45984-6482 | 65.3 | 67.68 | | |
| 12 | 45984-6413 | 47.5 | 49.90 | | |
| 16 | 45984-6423 | 50.0 | 52.44 | | |
| 20 | 45984-6433 | 52.6 | 54.98 | 2.90 | 1.57 |
| 24 | 45984-6443 | 55.1 | 57.52 | | |
| 28 | 45984-6453 | 57.6 | 60.06 | | |
| 32 | 45984-6463 | 60.2 | 62.60 | | |
| 36 | 45984-6473 | 62.7 | 65.14 | | |
| 40 | 45984-6483 | 65.3 | 67.68 | | |

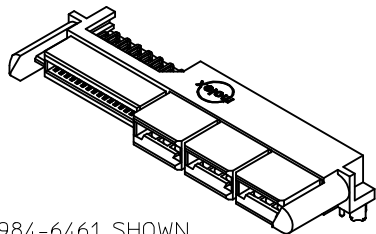

45984-6461 SHOWN
FOR REF ONLY
SEE CHART

| | | | | |
|---------------|---------------------|-------------|-------------|------------|
| REVISED | EC NO: UCP2009-0971 | 2008/11/13 | 2008/11/14 | 2008/11/17 |
| DRWN:MBANDURA | CHKD: | APPR:APATEL | DESCRIPTION | |
| REV | | | | |

| | | |
|--|--------|-------|
| GENERAL TOLERANCES (UNLESS SPECIFIED) | | |
| | mm | INCH |
| 4 PLACES | ± --- | ± --- |
| 3 PLACES | ± --- | ± --- |
| 2 PLACES | ± 0.25 | ± --- |
| 1 PLACE | ± --- | ± --- |
| ANGULAR ±1/2° | | |
| DRAFT WHERE APPLICABLE MUST REMAIN WITHIN DIMENSIONS | | |

| | |
|-----------------|------------|
| DIMENSION STYLE | |
| MM ONLY | |
| DRAWN BY | DATE |
| SAMIEC | 2005/05/13 |
| CHECKED BY | DATE |
| SAMIEC | 2005/05/13 |
| APPROVED BY | DATE |
| MARGULIS | 2005/05/13 |
| MATERIAL NO. | |
| SIZE | A |

| | | | |
|---|--------------|------------------------|-----------|
| SCALE | DESIGN UNITS | THIRD ANGLE PROJECTION | |
| 1:1 | METRIC | | |
| TITLE | | | |
| LPH RECEPTACLE ASSEMBLY RT ANGLE 6 CIRCUIT POWER CONNECTOR | | | |
| MOLEX INCORPORATED | | | |
| DOCUMENT NO. | | | SHEET NO. |
| SD-45984-600 | | | 4 OF 5 |
| THIS DRAWING CONTAINS INFORMATION THAT IS PROPRIETARY TO MOLEX INCORPORATED AND SHOULD NOT BE USED WITHOUT WRITTEN PERMISSION | | | |

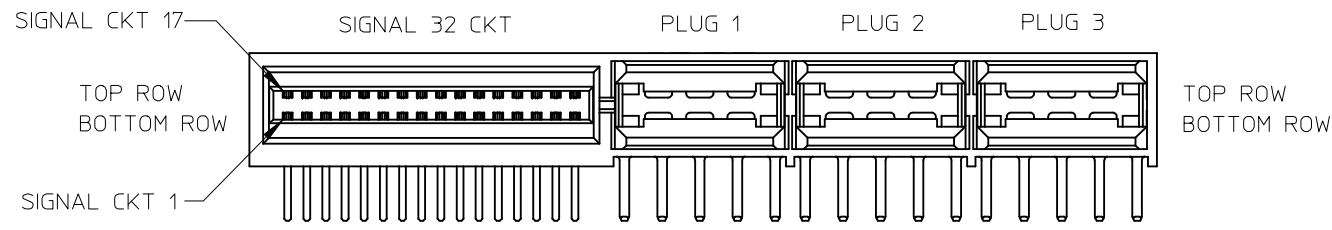

| NO. OF SIGNAL | DIM. D |
|---------------|--------|
| 12 | 8.00 |
| 16 | 10.54 |
| 20 | 13.08 |
| 24 | 15.62 |
| 28 | 18.16 |
| 32 | 20.70 |
| 36 | 23.24 |
| 40 | 25.78 |

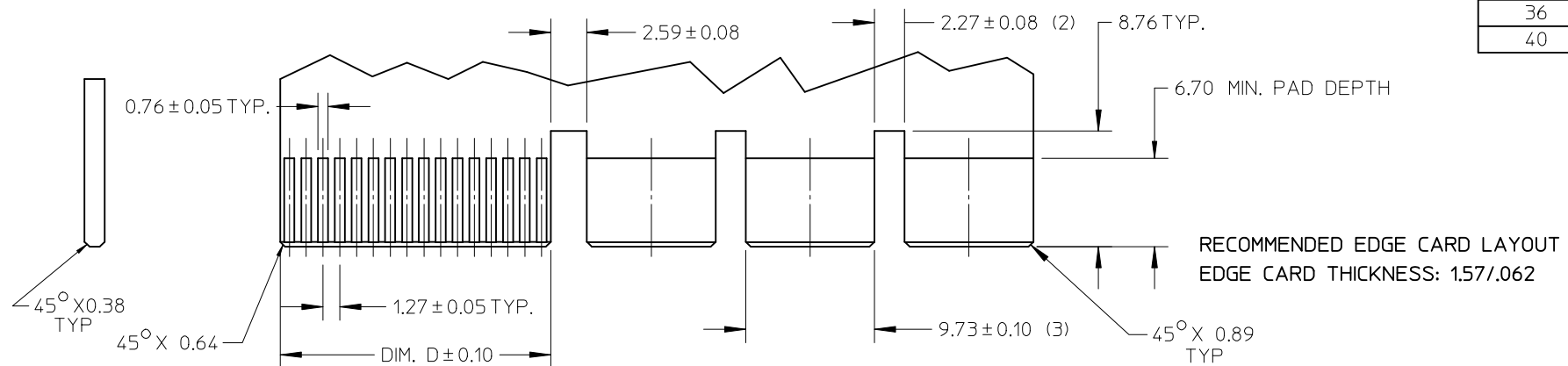

RECOMMENDED EDGE CARD LAYOUT
EDGE CARD THICKNESS: 1.57/0.62

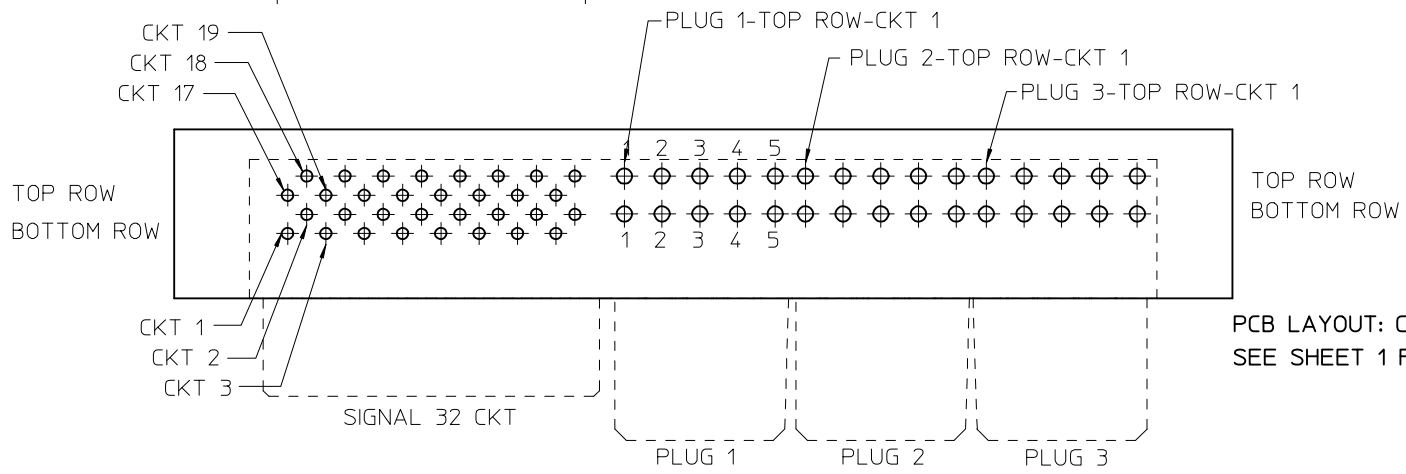

| | | | | |
|---------------|---------------------|-------------|-------------|------------|
| REVISED | EC NO: UCP2009-0971 | 2008/11/13 | 2008/11/14 | 2008/11/17 |
| DRWN:MBANDURA | CHKD: | APPR:APATEL | DESCRIPTION | REV |

| GENERAL TOLERANCES (UNLESS SPECIFIED) | | |
|--|--------|-------|
| | mm | INCH |
| 4 PLACES | ± --- | ± --- |
| 3 PLACES | ± --- | ± --- |
| 2 PLACES | ± 0.25 | ± --- |
| 1 PLACE | ± --- | ± --- |
| ANGULAR ±1/2° | | |
| DRAFT WHERE APPLICABLE MUST REMAIN WITHIN DIMENSIONS | | |

| DIMENSION STYLE | |
|-----------------|------------|
| MM ONLY | |
| DRAWN BY | DATE |
| SAMIEC | 2005/05/13 |
| CHECKED BY | DATE |
| SAMIEC | 2005/05/13 |
| APPROVED BY | DATE |
| MARGULIS | 2005/05/13 |
| MATERIAL NO. | |

| | | |
|---|--------------|------------------------|
| SCALE | DESIGN UNITS | THIRD ANGLE PROJECTION |
| 2:1 | METRIC | |
| TITLE | | |
| LPH RECEPTACLE ASSEMBLY RT ANGLE 6 CIRCUIT POWER CONNECTOR | | |
| MOLEX INCORPORATED | | |
| DOCUMENT NO. | SHEET NO. | |
| SD-45984-600 | 5 OF 5 | |
| THIS DRAWING CONTAINS INFORMATION THAT IS PROPRIETARY TO MOLEX INCORPORATED AND SHOULD NOT BE USED WITHOUT WRITTEN PERMISSION | | |