

FMCE-1528 EMI Input Filters

28 VOLT INPUT – 15 AMP

FEATURES

Attenuation to 70 dB at 500 kHz, typical

- Operating temperature -55° to +125°C
- Nominal 28 V input, -0.5 to 50 V operation
- Transient rating -0.5 to 80 V for 1 second
- Up to 15 A throughput current over the full input voltage range of -0.5 to 50 V
- Compliant to
 - MIL-STD-461C,CE03
 - MIL-STD-461D, E and F CE102
 - MIL-STD-461C CS01
 - MIL-STD-461D, E and F CS101
- Compatible with MIL-STD-704 A-E 28 VDC power bus



INPUT VOLTAGE AND CURRENT

Input (V)	Current (A)
28	15

DESCRIPTION

The FMCE-1528™ EMI filters are specifically designed to reduce the reflected input ripple current of Interpoint's high frequency DC/DC converters. FMCE-1528 filters minimize electromagnetic interference (EMI) for the MFL, MOR, MTR, MHV, and MHF+ Series of converters. These filters are intended for use in 28 volt applications which must meet MIL-STD-461C CE03 and CS01 and/or MIL-STD-461D, E and F CE102 and CS101 levels of conducted emissions. One filter can be used with multiple converters up to the rated output current of the filter.

INPUT RIPPLE AND EMI

Switching DC/DC converters naturally generate two noise components on the power input line: differential noise and common mode noise. Input ripple current refers to both of these components. Differential noise occurs between the positive input and input common. Most Interpoint converters have an input filter that reduces differential noise which is sufficient for many applications. Common mode noise occurs across stray capacitances between the converter's power train components and the baseplate (bottom of the package) of the converter.

Where low noise currents are required to meet MIL-STD-461, a power line filter is needed. The FMCE-1528 EMI power line filters reduce the common mode and differential noise generated by the converters. FMCE-1528 filters reduce input ripple current by as much as 70 dB at 500 kHz and 1 MHz when used in conjunction with Interpoint's DC/DC converters.

Place the filter as close as possible to the converter for optimum performance. The baseplates of the filter and the converter should be connected with the shortest and widest possible conductors.

TRANSIENTS

A transient of -0.5 to +80 volts (0.5 ohm source impedance) will not damage the filter but will be passed on to the converter:

OPERATION OVER TEMPERATURE

The FMCE-1528 Series filters are rated for full power operation from -55°C to +125°C case temperature. Current is derated linearly to 80% at +135°C case temperature.

INSERTION LOSS

The maximum dc insertion loss at full load and nominal input voltage represents a power loss of less than 4%.

PACKAGING

FMCE-1528 filters are sealed in metal hermetic side-leaded packages. See cases U, V, W, Y, and Z.

FMCE-1528 EMI Input Filters

28 VOLT INPUT – 15 AMP

OPERATING CONDITIONS AND CHARACTERISTICS

Input Voltage Range

- Continuous -0.5 to 50 VDC
- Transient -0.5 to 80 V for 1 second

Lead Soldering Temperature (10 sec per lead)

- 300°C

Storage Temperature Range (Case)

- -65°C to +150°C

Case Operating Temperature (T_C)

- -55°C to +125°C full power
- -55°C to +135°C absolute

Derating Input/Output Current

- Linearly from 100% at 125°C to 80% at 135°C

Isolation ($T_C = 25^\circ\text{C}$)

- 100 megohm minimum at 500 VDC
- Any pin to case

Electrostatic Discharge (ESD) Sensitivity per MIL-PRF-38534

- Classification 3B, 8000 V

MECHANICAL AND ENVIRONMENTAL

Size (maximum)

- Case U
3.005 x 1.505 x 0.400 inches (76.33 x 38.23 x 10.16 mm)
The image on page one shows Case U (flanged, short leads)
- Also available:
 - Flanged: leads bent down (case V)
 - Tabbed: leads bent up (case W)
 - Tabbed: short leads (case Y)
 - Tabbed: leads bent down (case Z)
- See cases U, V, W, Y, and Z for dimensions and options

Weight (maximum)

- 86 grams all cases (U, V, W, Y, and Z)

Screening

The FMCE-1528 EMI Input filter offers Standard, /ES or 883, Class H, QML screening. See Screening Tables 1 and 2 for more information.

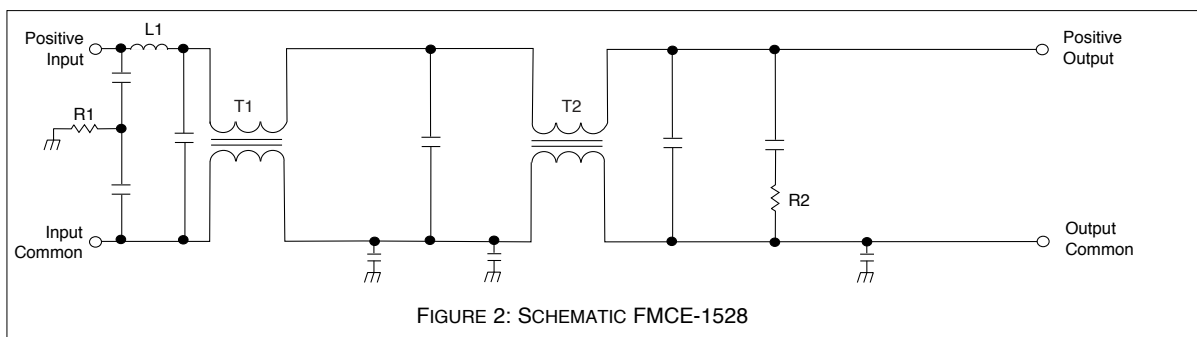
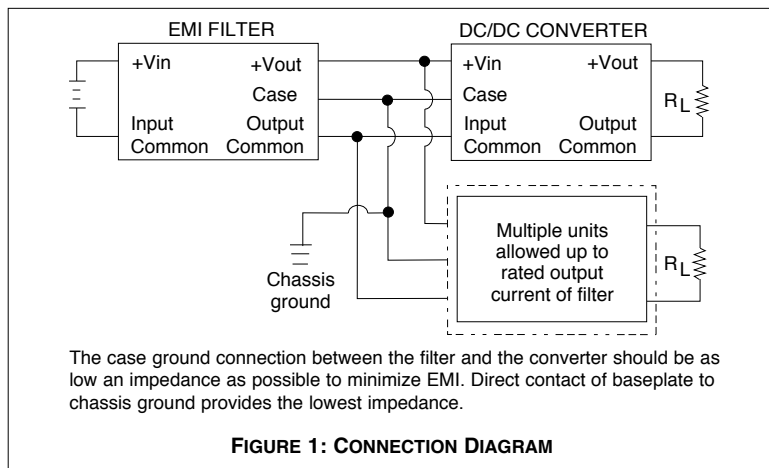

FMCE-1528 EMI Input Filters

28 VOLT INPUT – 15 AMP

PIN OUT

PIN OUT	
Pin	Designation
1, 2, 3	Positive Input
4, 5, 6	Input Common
7, 8, 9	Output Common
10, 11, 12	Positive Output
Bottom of case	Case Ground

- Notes
1. All pins must be connected.
 2. The baseplate is the only case ground connection and should directly contact chassis ground.

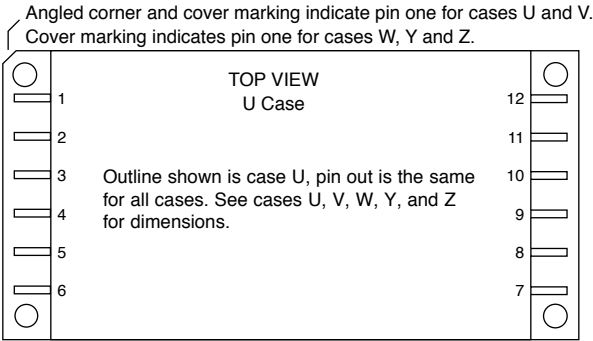
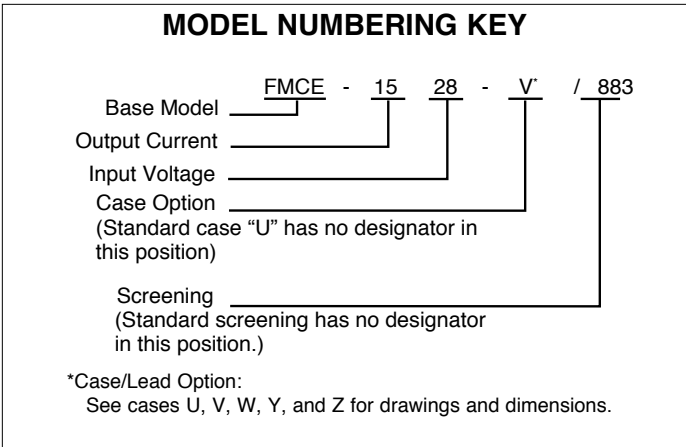

FIGURE 3: PIN OUT

FMCE-1528 EMI Input Filters

28 VOLT INPUT – 15 AMP



DSCC NUMBERS	
DSCC DRAWING (5915)	FMCE-1528 SIMILAR PART
10018-01HTC	FMCE-1528-W/883
10018-01HUC	FMCE-1528-V/883
10018-01HXC	FMCE-1528/883
10018-01HYC	FMCE-1528-Y/883
10018-01HZC	FMCE-1528-Z/883
For exact specifications for a DSCC product, refer to the DSCC drawing. DSCC drawings can be downloaded from: http://www.dsccl.dla.mil/programs/smc	

Case Options: DSCC Cross Referenced to Interpoint	
DSCC Case Option	Interpoint Case Option
T	W
U	V
X	(standard case, no option required)
Y	Y
Z	Z

MODEL SELECTION ON THE LINES BELOW, ENTER ONE SELECTION FROM UNDER EACH CATEGORY TO DETERMINE THE MODEL NUMBER.			
CATEGORY	FMCE-1528 BASE MODEL AND INPUT VOLTAGE	- _____ CASE/LEAD OPTION ¹	/ _____ SCREENING ²
SELECTION	"FMCE-1528" is the only available selection	(STANDARD CASE U leave blank) V W Y Z	(STANDARD leave blank) ES 883 (Class H, QML)
Notes: 1. Case U is the standard, side-leaded, flanged case. Leave the option blank for case U. Refer to the case drawings on pages 8 - 12 for other case options. 2. Leave blank for standard screening. Use "ES" for "ES" screening and "883" for Class H screening. See screening Tables 1 and 2 for more information.			

FMCE-1528 EMI Input Filters

28 VOLT INPUT – 15 AMP

Electrical Characteristics: -55° to +125°C T_C, nominal Vin, unless otherwise specified.

PARAMETER	MODEL	FMCE-1528			UNITS
		MIN	TYP	MAX	
INPUT VOLTAGE	CONTINUOUS	-0.5	28	50	VDC
	TRANSIENT, 1 sec ^{1, 2}	-0.5	—	80	V
NOISE REJECTION	500 KHZ	60	70	—	dB
	1 MHZ	60	70	—	
DC RESISTANCE (R _{DC}) AT MAXIMUM CURRENT	T _C = 25°C	—	—	0.06	Ω
	T _C = 125°C ¹	—	—	0.07	
CAPACITANCE	ANY PIN TO CASE T _C = 25°C	50,000	60,000	70,000	pF
OUTPUT VOLTAGE ³	STEADY STATE	$V_{OUT} = V_{IN} - I_{IN} (R_{DC})$			VDC
OUTPUT CURRENT	STEADY STATE V _{IN} = -0.5 - 50 VDC	—	—	15	A
POWER DISSIPATION AT MAXIMUM CURRENT ¹	T _C = 25°C	—	—	13.5	W
	T _C = 125°C	—	—	15.75	

Note

1. **Guaranteed by design, not tested.**
2. 0.5 ohm source impedance
3. Typical applications result in Vout within 4% of Vin.

FMCE-1528 EMI Input Filters

28 VOLT INPUT – 15 AMP

Typical Performance Curves: 25°C T_C, nominal Vin, unless otherwise specified.

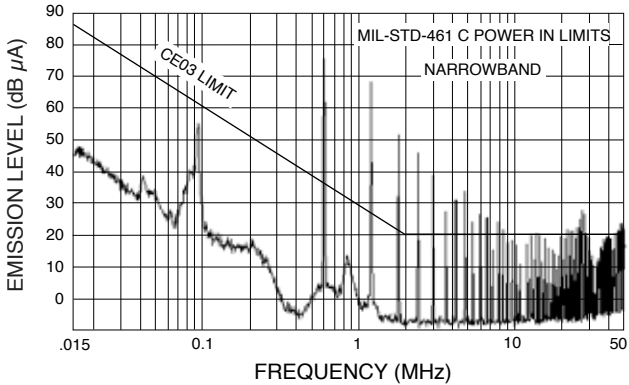

Three paralleled and synchronized MFL2815D converters without filtering.

FIGURE 4

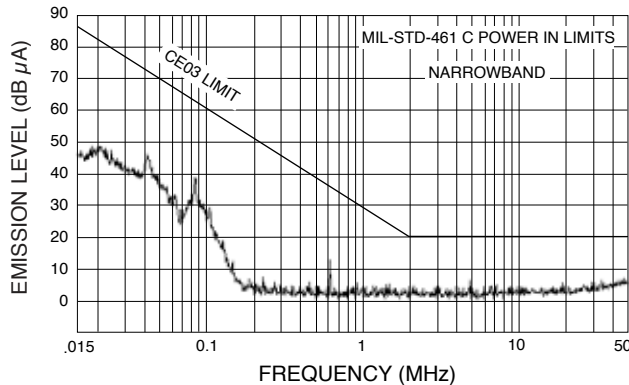

CE03: Three paralleled and synchronized MFL2815D converters with an FMCE-1528.

FIGURE 5

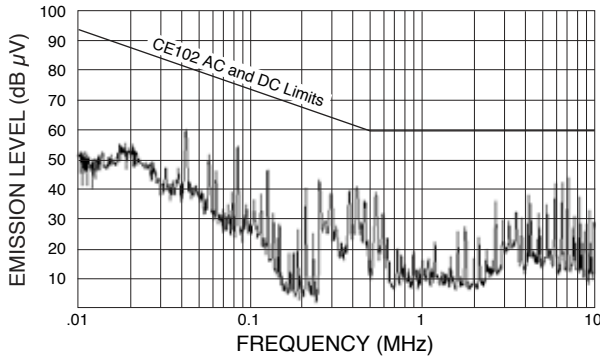

CE102: Three paralleled and synchronized MFL2815D converters with an FMCE-1528.

FIGURE 6

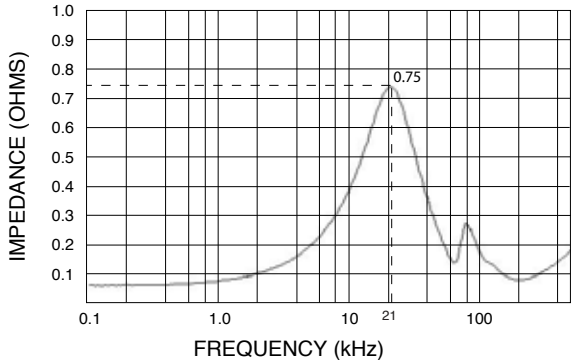

FMCE-1528 Output Impedance (measured at the output with input pins shorted)

FIGURE 7

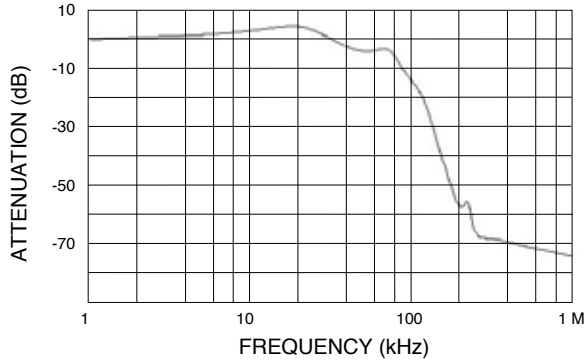

FMCE-1528 Attenuation

FIGURE 8

FMCE-1528 EMI Input Filters – Cases

28 VOLT INPUT – 15 AMP

TOP VIEW CASE U* Flanged case, short-leaded

*Does not require designator in Case Option position of model number.

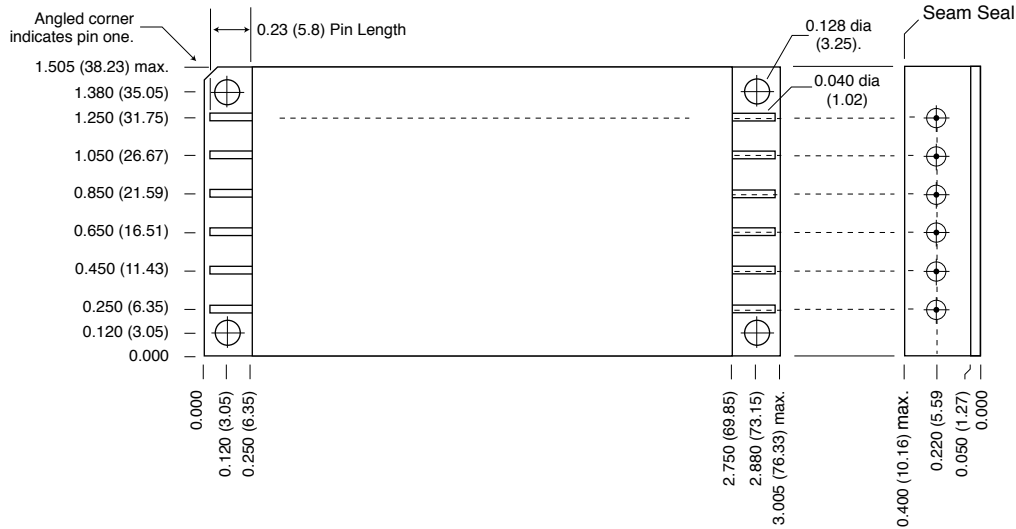

Case dimensions in inches (mm)
 Tolerance ± 0.005 (0.13) for three decimal places
 ± 0.01 (0.3) for two decimal places
 unless otherwise specified

CAUTION
 Heat from reflow or wave soldering may damage the device. Solder pins individually with heat application not exceeding 300°C for 10 seconds per pin.

Materials
 Header Cold Rolled Steel/Nickel/Gold
 Cover Kovar/Nickel
 Pins #52 alloy/Gold, compression glass seal
 Seal Hole: 0.100 ± 0.002 (2.54 ± 0.05)

Case U, Rev F, 20100503

FIGURE 9: CASE U

FMCE-1528 EMI Input Filters – Cases

28 VOLT INPUT – 15 AMP

TOP VIEW CASE V* Flanged case, down leaded

*Designator "V" required in Case Option position of model number.

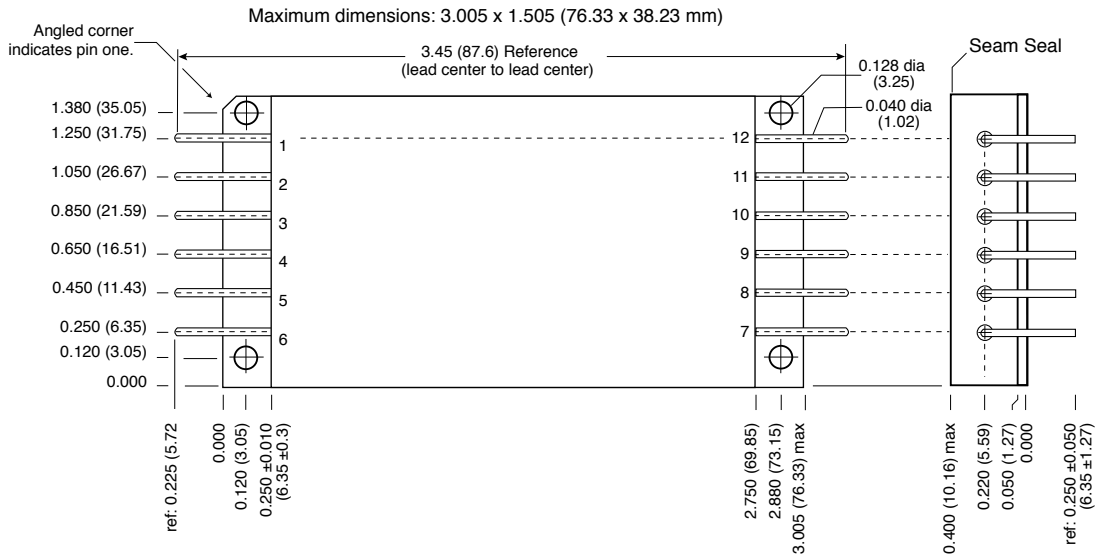

Case dimensions in inches (mm)

Tolerance ± 0.005 (0.13) for three decimal places
 ± 0.01 (0.3) for two decimal places
 unless otherwise specified

CAUTION

Heat from reflow or wave soldering may damage the device. Solder pins individually with heat application not exceeding 300°C for 10 seconds per pin.

Materials

Header Cold Rolled Steel/Nickel/Gold
 Cover Kovar/Nickel
 Pins #52 alloy/Gold, compression glass seal
 Seal Hole: 0.120 ± 0.002 (3.05 ±0.05)

Case V, Rev F, 20100413

Please refer to the numerical dimensions for accuracy. All information is believed to be accurate, but no responsibility is assumed for errors or omissions. Interpoint reserves the right to make changes in products or specifications without notice.
 Copyright © 1999-2010 Interpoint Corp. All rights reserved.

FIGURE 10: CASE V

FMCE-1528 EMI Input Filters – Cases

28 VOLT INPUT – 15 AMP

TOP VIEW CASE W*

Tabbed case, up-lead

*Designator "W" required in Case Option position of model number.

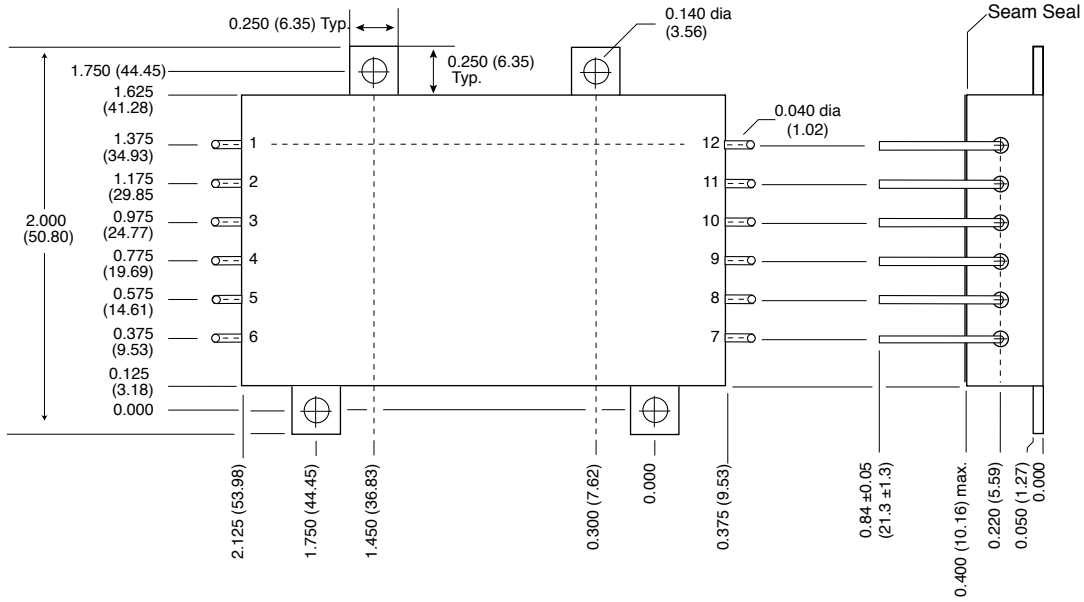

Case dimensions in inches (mm)

Tolerance ±0.005 (0.13) for three decimal places
 ±0.01 (0.3) for two decimal places
 unless otherwise specified

CAUTION

Heat from reflow or wave soldering may damage the device. Solder pins individually with heat application not exceeding 300°C for 10 seconds per pin.

Materials

- Header Cold Rolled Steel/Nickel/Gold
- Cover Kovar/Nickel
- Pins #52 alloy/Gold, compression glass seal
- Seal Hole: 0.120 ± 0.002 (3.05 ± 0.05)

Case W, Rev E, 20100413
 Please refer to the numerical dimensions for accuracy. All information is believed to be accurate, but no responsibility is assumed for errors or omissions. Interpoint reserves the right to make changes in products or specifications without notice.
 Copyright © 1999-2010 Interpoint Corp. All rights reserved.

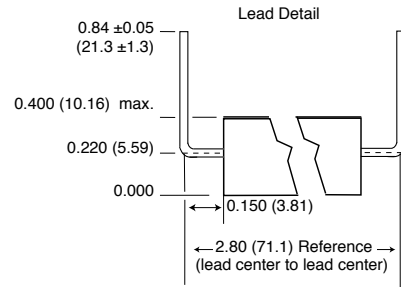

FIGURE 11: CASE W

FMCE-1528 EMI Input Filters – Cases

28 VOLT INPUT – 15 AMP

TOP VIEW CASE Y* Tabbed case, straight-leaded

*Designator "Y" required in Case Option position of model number.

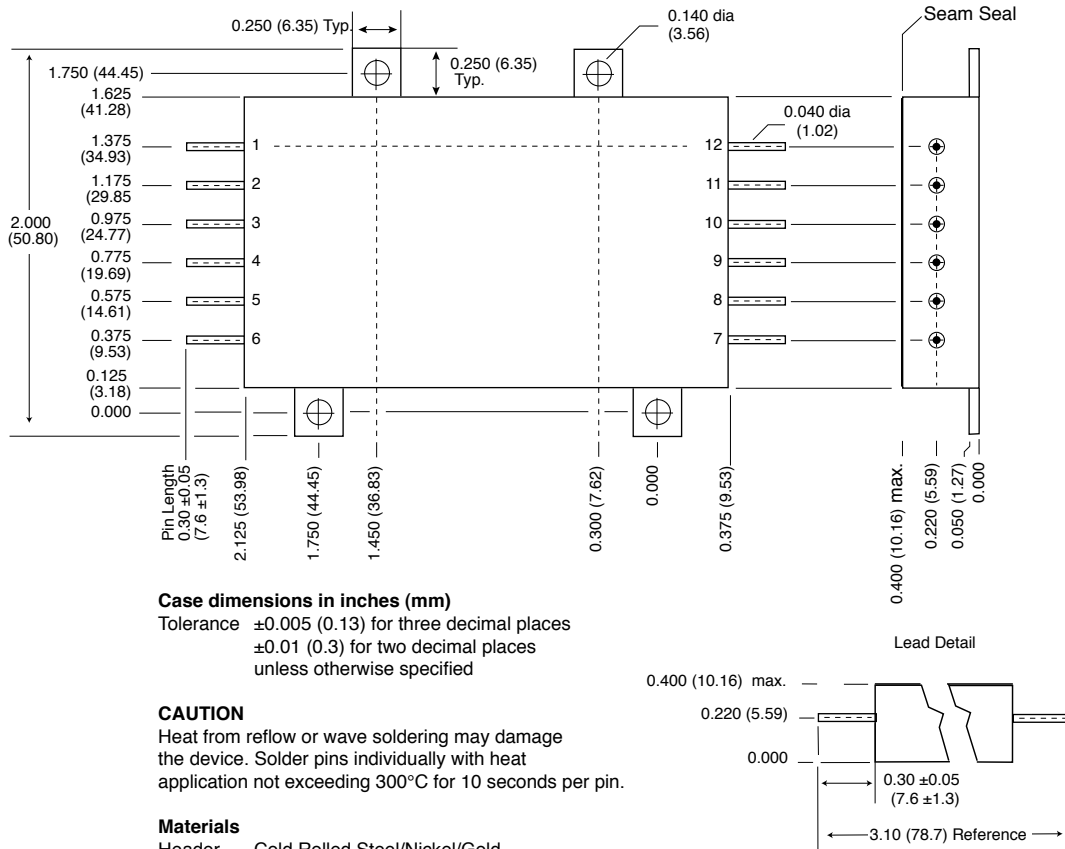

Case Y, Rev E, 20100413

Please refer to the numerical dimensions for accuracy. All information is believed to be accurate, but no responsibility is assumed for errors or omissions. Interpoint reserves the right to make changes in products or specifications without notice. Copyright © 1999-2010 Interpoint Corp. All rights reserved.

FIGURE 12: CASE Y

FMCE-1528 EMI Input Filters – Cases

28 VOLT INPUT – 15 AMP

TOP VIEW CASE Z* Tabbed case, down-leaded

*Designator "Z" required in Case Option position of model number.

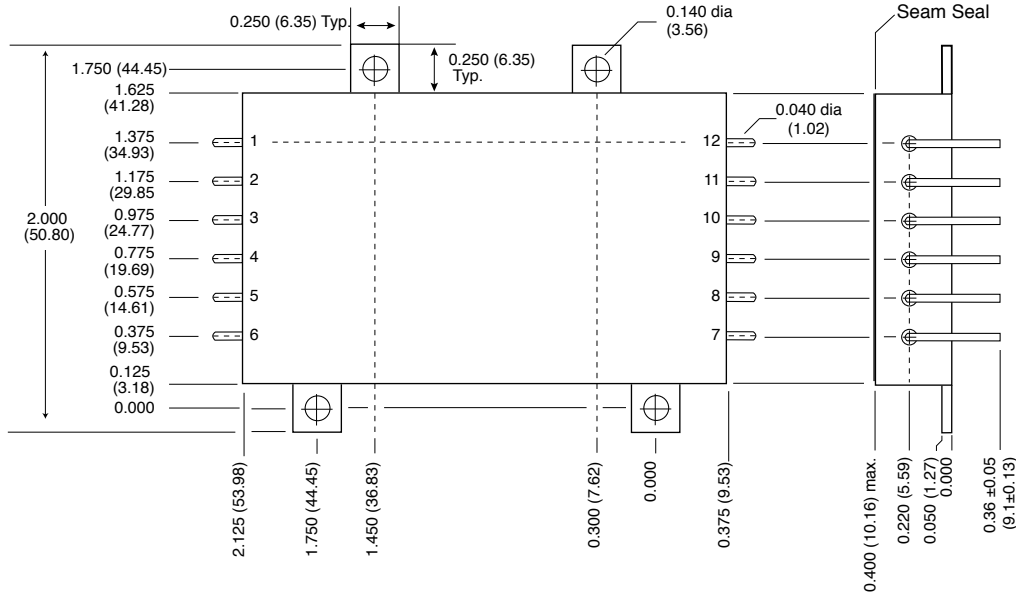

Case dimensions in inches (mm)
 Tolerance ± 0.005 (0.13) for three decimal places
 ± 0.01 (0.3) for two decimal places
 unless otherwise specified

CAUTION
 Heat from reflow or wave soldering may damage the device. Solder pins individually with heat application not exceeding 300°C for 10 seconds per pin.

Materials
 Header Cold Rolled Steel/Nickel/Gold
 Cover Kovar/Nickel
 Pins #52 alloy/Gold, compression glass seal
 Seal Hole: 0.120 ± 0.002 (3.05 ± 0.05)

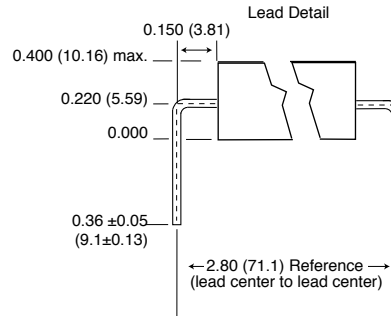

Case Z, Rev E, 20100413
 Please refer to the numerical dimensions for accuracy. All information is believed to be accurate, but no responsibility is assumed for errors or omissions. Interpoint reserves the right to make changes in products or specifications without notice.
 Copyright © 1999-2010 Interpoint Corp. All rights reserved.

FIGURE 13: CASE Z

FMCE-1528 EMI Input Filters

28 VOLT INPUT – 15 AMP

STANDARD AND /ES (NON-QML) AND /883 (CLASS H, QML) PRODUCT ELEMENT EVALUATION

COMPONENT-LEVEL TEST PERFORMED	STANDARD AND /ES NON-QML ¹		/883 CLASS H QML	
	M/S ²	P ³	M/S ²	P ³
Element Electrical (probe)	yes	no	yes	yes
Element Visual	no	no	yes	yes
Internal Visual	no	N/A	yes	N/A
Final Electrical	no	no	yes	yes
Wire Bond Evaluation ⁴	no	no	yes	yes
SLAM™/C-SAM: Input capacitors only (Add'l test, not req. by H)	no	no	no	yes

Notes:

1. Standard and /ES, non-QML products, do not meet all of the requirements of MIL-PRF-38534.
2. M/S = Active components (Microcircuit and Semiconductor Die)
3. P = Passive components
4. Not applicable to EMI filters that have no wire bonds.

Definitions:

Element Evaluation: Component testing/screening per MIL-STD-883 as determined by MIL-PRF-38534
 SLAM™: Scanning Laser Acoustic Microscopy
 C-SAM: C - Mode Scanning Acoustic Microscopy

SCREENING TABLE 1: ELEMENT EVALUATION

FMCE-1528 EMI Input Filters

28 VOLT INPUT – 15 AMP

STANDARD AND /ES (NON-QML) AND /883 (CLASS H, QML) PRODUCT ENVIRONMENTAL SCREENING

TEST PERFORMED	125°C STANDARD NON-QML ¹	125°C /ES NON-QML ¹	/883 CLASS H QML
Pre-cap Inspection Method 2017, 2032	yes	yes	yes
Temperature Cycle (10 times) Method 1010, Cond. C, -65°C to 150°C, ambient Method 1010, Cond. B, -55°C to 125°C, ambient	no no	no yes	yes no
Constant Acceleration Method 2001, 3000 g Method 2001, 500 g	no no	no yes	yes no
Burn-in ² Method 1015, 125°C case, typical 96 hours 160 hours	no no	yes no	no yes
Final Electrical Test MIL-PRF-38534, Group A Subgroups 1 through 6: -55°C, +25°C, +125°C case Subgroups 1 and 4: +25°C case	no yes	no yes	yes no
Hermeticity Test Fine Leak, Method 1014, Cond. A Gross Leak, Method 1014, Cond. C Gross Leak, Dip (1 x 10 ⁻³)	no no yes	yes yes no	yes yes no
Final visual inspection Method 2009	yes	yes	yes

Test methods are referenced to MIL-STD-883 as determined by MIL-PRF-38534.

Notes:

- Standard and /ES, non-QML products, do not meet all of the requirements of MIL-PRF-38534.
- Burn-in temperature designed to bring the case temperature to +125°C

SCREENING TABLE 2: ENVIRONMENTAL SCREENING