

DDR3 SDRAM Memory

Product Guide

SAMSUNG ELECTRONICS RESERVES THE RIGHT TO CHANGE PRODUCTS, INFORMATION AND SPECIFICATIONS WITHOUT NOTICE.

Products and specifications discussed herein are for reference purposes only. All information discussed herein is provided on an "AS IS" basis, without warranties of any kind.

This document and all information discussed herein remain the sole and exclusive property of Samsung Electronics. No license of any patent, copyright, mask work, trademark or any other intellectual property right is granted by one party to the other party under this document, by implication, estoppel or otherwise.

Samsung products are not intended for use in life support, critical care, medical, safety equipment, or similar applications where product failure could result in loss of life or personal or physical harm, or any military or defense application, or any governmental procurement to which special terms or provisions may apply.

For updates or additional information about Samsung products, contact your nearest Samsung office.

All brand names, trademarks and registered trademarks belong to their respective owners.

© 2010 Samsung Electronics Co., Ltd. All rights reserved.

1. DDR3 SDRAM MEMORY ORDERING INFORMATION

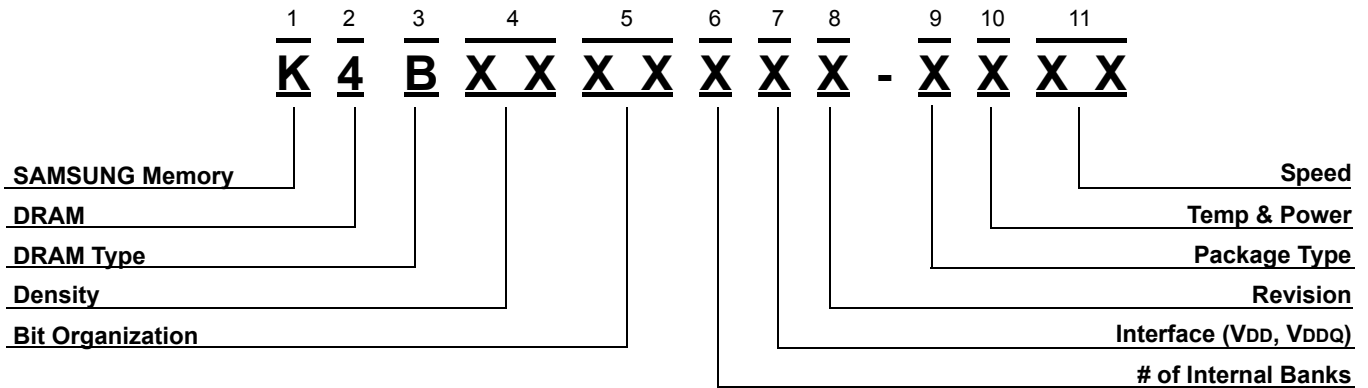

1. SAMSUNG Memory : K

2. DRAM : 4

3. DRAM Type

B : DDR3 SDRAM

4. Density

51 : 512Mb
 1G : 1Gb
 2G : 2Gb
 4G : 4Gb

5. Bit Organization

04 : x 4
 08 : x 8
 16 : x16

6. # of Internal Banks

3 : 4 Banks
 4 : 8 Banks
 5 : 16 Banks

7. Interface (VDD, VDDQ)

6 : SSTL (1.5V, 1.5V)

8. Revision

M : 1st Gen.
 A : 2nd Gen.
 B : 3rd Gen.
 C : 4th Gen.
 D : 5th Gen.
 E : 6th Gen.
 F : 7th Gen.
 G : 8th Gen.
 H : 9th Gen.

9. Package Type

Z : FBGA (Lead-free)
 H : FBGA (Halogen-free & Lead-free)
 J : FBGA (Lead-free, DDP)
 M : FBGA (Halogen-free & Lead-free, DDP)

10. Temp & Power

C : Commercial Temp.(0°C ~ 85°C) & Normal Power
 L : Commercial Temp.(0°C ~ 85°C) & Low Power
 Y : Commercial Temp.(0°C ~ 85°C) & Low VDD(1.35V)

11. Speed

F7 : DDR3-800 (400MHz @ CL=6, tRCD=6, tRP=6)
 F8 : DDR3-1066 (533MHz @ CL=7, tRCD=7, tRP=7)
 H9 : DDR3-1333 (667MHz @ CL=9, tRCD=9, tRP=9)
 K0 : DDR3-1600 (800MHz @ CL=11, tRCD=11, tRP=11)

2. DDR3 SDRAM Component Product Guide

Density	Banks	Part Number	Package & Power, Temp. (-C/-L) & Speed	Org.	VDD Voltage	PKG	Avail.	NOTE
1Gb E-die	8Banks	K4B1G0446E	HC(L)F7/F8/H9/K0	256M x 4	1.5V	78 ball FBGA	Now	
		K4B1G0846E	HC(L)F7/F8/H9/K0	128M x 8				
		K4B1G1646E	HC(L)F7/F8/H9/K0	64M x 16				
		K4B1G0446E	HYF7/F8/H9	256M x 4	1.35V	78 ball FBGA		
		K4B1G0846E	HYF7/F8/H9	128M x 8				
1Gb F-die	8Banks	K4B1G0446F	HC(L)F8/H9/K0	256M x 4	1.5V	78 ball FBGA	Now	
		K4B1G0846F	HC(L)F8/H9/K0	128M x 8				
		K4B1G0446F	HY(L)F8/H9	256M x 4	1.35V			
		K4B1G0846F	HY(L)F8/H9	128M x 8				
2Gb B-die	8Banks	K4B2G0446B	HC(L)F7/F8/H9	512M x 4	1.5V	78 ball FBGA	Now	
		K4B2G0846B	HC(L)F7/F8/H9	256M x 8		96 ball FBGA		
		K4B2G1646B	HC(L)F7/F8/H9	128M x 16				
		K4B2G0446B	HYF7/F8/H9	512M x 4	1.35V	78 ball FBGA		
		K4B2G0846B	HYF7/F8/H9	256M x 8				
2Gb C-die	8Banks	K4B2G0446C	HC(L)F8/H9/K0	512M x 4	1.5V	78 ball FBGA	Now	
		K4B2G0846C	HC(L)F8/H9/K0	256M x 8				
		K4B2G0446C	HY(L)F8/H9	512M x 4	1.35V			
		K4B2G0846C	HY(L)F8/H9	256M x 8				
DDP 2Gb E-die	8Banks	K4B2G0446E	MC(L)F7/F8/H9	512M x 4	1.5V	78 ball FBGA	Now	
		K4B2G0846E	MC(L)F7/F8/H9	256M x 8				
4Gb A-die	8Banks	K4B4G0446A	HC(L)F8/H9/K0	1G x 4	1.5V	78 ball FBGA	Now	
		K4B2G0846A	HC(L)F8/H9/K0	512M x 8				
		K4B4G0446A	HY(L)F8/H9/K0	1G x 4	1.35V			
		K4B2G0846A	HY(L)F8/H9/K0	512M x 8				
DDP 4Gb B-die	8Banks	K4B4G0446B	MC(L)F7/F8/H9	1G x 4	1.5V	78 ball FBGA	Now	
		K4B2G0846B	MC(L)F7/F8/H9	512M x 8				
DDP 4Gb C-die	8Banks	K4B4G0446C	MC(L)F7/F8/H9	1G x 4	1.5V	78 ball FBGA	Feb.'10	
		K4B2G0846C	MC(L)F7/F8/H9	512M x 8				

* NOTE : 1.35V product is 1.5V operatable.

3. DDR3 SDRAM Module Ordering Information

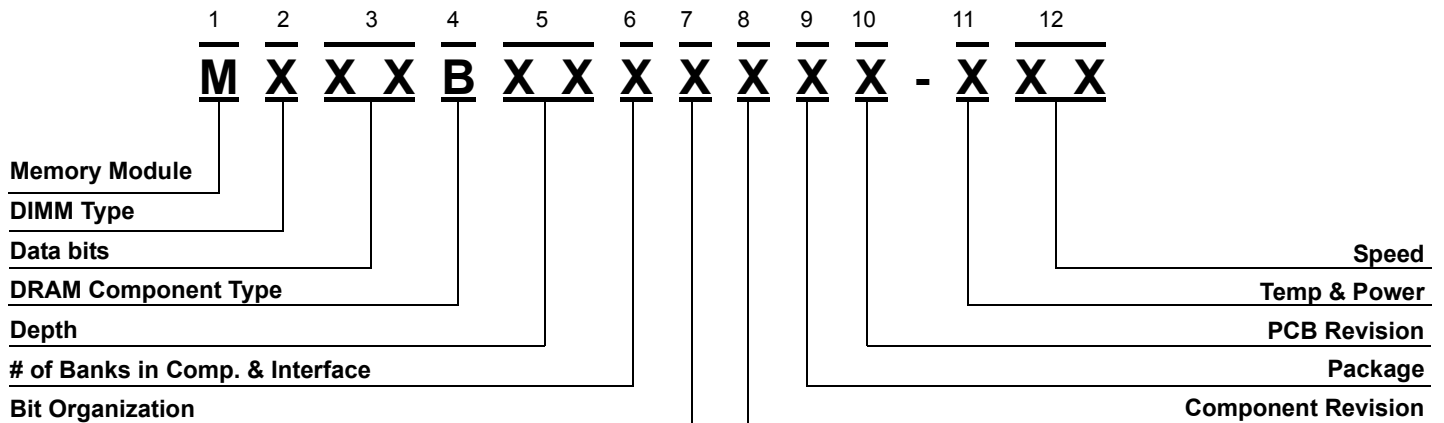

1. Memory Module : M

2. DIMM Type

- 3 : DIMM
- 4 : SODIMM

3. Data Bits

- 71 : x64 204pin Unbuffered SODIMM
- 78 : x64 240pin Unbuffered DIMM
- 91 : x72 240pin ECC unbuffered DIMM
- 92 : x72 240pin VLP Registered DIMM
- 93 : x72 240pin Registered DIMM

4. DRAM Component Type

- B : DDR3 SDRAM (1.5V VDD)

5. Depth

- 32 : 32M
- 64 : 64M
- 28 : 128M
- 56 : 256M
- 51 : 512M
- 1G : 1G
- 2G : 2G
- 33 : 32M (for 128Mb/512Mb)
- 65 : 64M (for 128Mb/512Mb)
- 29 : 128M (for 128Mb/512Mb)
- 57 : 256M (for 512Mb/2Gb)
- 52 : 512M (for 512Mb/2Gb)
- 1K : 1G (for 2Gb)
- 2K : 2G (for 2Gb)

6. # of Banks in comp. & Interface

- 7 : 8Banks & SSTL-1.5V

7. Bit Organization

- 0 : x4
- 3 : x8
- 4 : x16

8. Component Revision

- M : 1st Gen.
- B : 3rd Gen.
- D : 5th Gen.
- F : 7th Gen.
- A : 2nd Gen.
- C : 4th Gen.
- E : 6th Gen.
- G : 8th Gen.

9. Package

- Z : FBGA(Lead-free)
- H : FBGA(Lead-free & Halogen-free)
- J : FBGA(Lead-free, DDP)
- M : FBGA(Lead-free & Halogen-free, DDP)

10. PCB Revision

- 0 : None
- 2 : 2nd Rev.
- 4 : 4th Rev.
- 1 : 1st Rev.
- 3 : 3rd Rev.
- S : Reduced Layer

11. Temp & Power

- C : Commercial Temp.(0°C ~ 85°C) & Normal Power
- Y : Commercial Temp.(0°C ~ 85°C) & Low VDD(1.35V)

12. Speed

- F7 : DDR3-800 (400MHz @ CL=6, tRCD=6, tRP=6)
- F8 : DDR3-1066 (533MHz @ CL=7, tRCD=7, tRP=7)
- H9 : DDR3-1333 (667MHz @ CL=9, tRCD=9, tRP=9)
- K0 : DDR3-1600 (800MHz @ CL=11, tRCD=11, tRP=11)

NOTE: PC3-6400(DDR3-800),PC3-8500(DDR3-1066),
PC3-10600(DDR3-1333), PC3-12800(DDR3-1600)

4. DDR3 SDRAM Module Product Guide

4.1 240Pin DDR3 Unbuffered DIMM (1.5V Product)

240Pin DDR3 Unbuffered DIMM													
Org.	Density	Part Number	Speed	Raw Card	Composition	Comp. Version		Internal Banks	Rank	PKG	Height	Avail.	NOTE
128Mx 64	1GB	M378B2873EH1	CF8/H9	A(1Rx8)	128M x 8 * 8 pcs	1Gb	E-die	8	1	78 ball FBGA	30mm	Now	
		M378B2873FH0	CF8/H9/K0*		128M x 8 * 8 pcs	1Gb	F-die						
128Mx 72	1GB	M391B2873EH1	CF8/H9	D(1Rx8)	128M x 8 * 9 pcs	1Gb	E-die	8	1	78 ball FBGA	30mm	Now	
		M391B2873FH0	CF8/H9/K0*		128M x 8 * 9 pcs	1Gb	F-die						
256Mx 64	2GB	M378B5673EH1	CF8/H9	B(2Rx8)	128M x 8 * 16 pcs	1Gb	E-die	8	2	78 ball FBGA	30mm	Now	
		M378B5673FH0	CF8/H9/K0*		128M x 8 * 16 pcs	1Gb	F-die						
		M378B5773CH0	CF8/H9/K0*	A(1Rx8)	256M x 8 * 8 pcs	2Gb	C-die	8	1				
256Mx 72	2GB	M391B5673EH1	CF8/H9	E(2Rx8)	128M x 8 * 18 pcs	1Gb	E-die	8	2	78 ball FBGA	30mm	Now	
		M391B5673FH0	CF8/H9/K0*		128M x 8 * 18 pcs	1Gb	F-die						
		M391B5773CH0	CF8/H9/K0*	D(1Rx8)	256M x 8 * 9 pcs	2Gb	C-die	8	1				
512Mx 64	4GB	M378B5273BH1	CF8/H9	B(2Rx8)	256M x 8 * 16 pcs	2Gb	B-die	8	2	78 ball FBGA	30mm	Now	
		M378B5273CH0	CF8/H9/K0*		256M x 8 * 16 pcs	2Gb	C-die						
512Mx 72	4GB	M391B5273BH1	CF8/H9	E(2Rx8)	256M x 8 * 18 pcs	2Gb	B-die	8	2	78 ball FBGA	30mm	Now	
		M391B5273CH0	CF8/H9/K0*		256M x 8 * 18 pcs	2Gb	C-die						
1Gx 64	8GB	M378B1G73AH0	CF8/H9/K0*	B(2Rx8)	512M x 8 * 16 pcs	4Gb	A-die	8	2	78 ball FBGA	30mm	Now	
1Gx 72	8GB	M391B1G73AH0	CF8/H9/K0*	E(2Rx8)	512M x 8 * 18 pcs	4Gb	A-die	8	2	78 ball FBGA	30mm	Now	

* NOTE : K0(1600Mbps) will be available by ES level

4.2 240Pin DDR3 Unbuffered DIMM (1.35V Product)

240Pin DDR3 Unbuffered DIMM													
Org.	Density	Part Number	Speed	Raw Card	Composition	Comp. Version		Internal Banks	Rank	PKG	Height	Avail.	NOTE
128Mx 72	1GB	M391B2873EH1	YF8/H9	D(1Rx8)	128M x 8 * 9 pcs	1Gb	E-die	8	1	78 ball FBGA	30mm	Now	
		M391B2873FH0	YF8/H9		128M x 8 * 9 pcs	1Gb	F-die						
256Mx 72	2GB	M391B5673EH1	YF8/H9	E(2Rx8)	128M x 8 * 18 pcs	1Gb	E-die	8	2	78 ball FBGA	30mm	Now	
		M391B5673FH0	YF8/H9		128M x 8 * 18 pcs	1Gb	F-die						
		M391B5773CH0	YF8/H9	D(1Rx8)	256M x 8 * 9 pcs	2Gb	C-die	8	1				
512Mx 72	4GB	M391B5273BH1	YF8/H9	E(2Rx8)	256M x 8 * 18 pcs	2Gb	B-die	8	2	78 ball FBGA	30mm	Now	
		M391B5273CH0	YF8/H9		256M x 8 * 18 pcs	2Gb	C-die						
1Gx 72	8GB	M391B1G73AH0	YF8/H9	E(2Rx8)	512M x 8 * 18 pcs	4Gb	A-die	8	2	78 ball FBGA	30mm	Now	

* NOTE : 1.35V product is 1.5V operatable.

4.3 204Pin DDR3 SoDIMM (1.5V Product)

204Pin DDR3 SODIMM													
Org.	Density	Part Number	Speed	Raw Card	Composition	Comp. Version		Internal Banks	Rank	PKG	Height	Avail.	NOTE
128Mx 64	1GB	M471B2873EH1	CF8/H9	B(1Rx8)	128M x 8 * 8 pcs	1Gb	E-die	8	1	78 ball FBGA	30mm	Now	
		M471B2874EH1	CF8/H9	A(2Rx16)	64M x 16 * 8 pcs	1Gb	E-die	8	2	96 ball			
		M471B2873FHS	CF8/H9	B(1Rx8)	64M x 16 * 8 pcs	1Gb	F-die	8	1	78 ball FBGA			
256Mx 64	2GB	M471B5673EH1	CF8/H9	F(2Rx8)	128M x 8 * 16 pcs	1Gb	E-die	8	2	78 ball FBGA	30mm	Now	
		M471B5673FH0	CF8/H9		128M x 8 * 16 pcs	1Gb	F-die						
		M471B5773CHS	CF8/H9	B(1Rx8)	256M x 8 * 8 pcs	2Gb	C-die	8	1				
512Mx 64	4GB	M471B5273BH1	CF8/H9	F(2Rx8)	256M x 8 * 16 pcs	2Gb	B-die	8	2	78 ball FBGA	30mm	Now	
		M471B5273CH0	CF8/H9		256M x 8 * 16 pcs	2Gb	C-die						
1Gx 64	8GB	M471B1G73AH0	CF8/H9	F(2Rx8)	512M x 8 * 16 pcs	4Gb	A-die	8	2	78 ball FBGA	30mm	Now	

4.4 204Pin DDR3 SoDIMM (1.35V Product)

204Pin DDR3 SODIMM													
Org.	Density	Part Number	Speed	Raw Card	Composition	Comp. Version		Internal Banks	Rank	PKG	Height	Avail.	NOTE
128Mx 64	1GB	M471B2873FHS	YF8/H9	B(1Rx8)	128M x 8 * 8 pcs	1Gb	F-die	8	1	78 ball FBGA	30mm	Now	
256Mx 64	2GB	M471B5673FH0	YF8/H9	F(2Rx8)	128M x 8 * 16 pcs	1Gb	F-die	8	2	78 ball FBGA	30mm	Now	
		M471B5773CHS	YF8/H9	B(1Rx8)	256M x 8 * 8 pcs	2Gb	C-die	8	1				
512Mx 64	4GB	M471B5273BH1	YF8/H9	F(2Rx8)	256M x 8 * 16 pcs	2Gb	B-die	8	2	78 ball FBGA	30mm	Now	
		M471B5273CH0	YF8/H9		256M x 8 * 16 pcs	2Gb	C-die						
1Gx 64	8GB	M471B1G73AH0	YF8/H9	F(2Rx8)	512M x 8 * 16 pcs	4Gb	A-die	8	2	78 ball FBGA	30mm	Now	

* NOTE : 1.35V product is 1.5V operatable.

4.5 240Pin DDR3 Registered DIMM (1.5V Product)

240Pin DDR3 Registered DIMM													
Org.	Density	Part Number	Speed	Raw Card	Composition	Comp. Version		Internal Banks	Rank	PKG	Height	Avail.	NOTE
128Mx 72	1GB	M393B2873EH1	CF8/H9	A(1Rx8)	128M x 8 * 9 pcs	1Gb	E-die	8	1	78 ball FBGA	30mm	Now	
		M393B2873FH0	CF8/H9		128M x 8 * 9 pcs	1Gb	F-die						
256Mx 72	2GB	M393B5673EH1	CF8/H9	B(2Rx8)	128M x 8 * 18 pcs	1Gb	E-die	8	2	78 ball FBGA	30mm	Now	
		M393B5673FH0	CF8/H9		128M x 8 * 18 pcs	1Gb	F-die						
		M393B5670EH1	CF8/H9	C(1Rx4)	256M x 4 * 18 pcs	1Gb	E-die		1				
		M393B5670FH0	CF8/H9		256M x 4 * 18 pcs	1Gb	F-die						
		M393B5773CH0	CF8/H9		A(1Rx8)	256M x 8 * 9 pcs	2Gb						
512Mx 72	4GB	M393B5173EH1	CF8	H(4Rx8)	128M x 8 * 36 pcs	1Gb	E-die	8	4	78 ball FBGA	30mm	Now	
		M393B5173FH0	CF8/H9		128M x 8 * 36 pcs	1Gb	F-die						
		M393B5170EH1	CF8/H9	E(2Rx4)	256M x 4 * 36 pcs	1Gb	E-die		2				
		M393B5170FH0	CF8/H9		256M x 4 * 36 pcs	1Gb	F-die						
		M393B5273BH1	CF8/H9	B(2Rx8)	256M x 8 * 18 pcs	2Gb	B-die		2				
		M393B5273CH0	CF8/H9		256M x 8 * 18 pcs	2Gb	C-die						
		M393B5270BH1	CF8/H9	C(1Rx4)	512M x 4 * 18 pcs	2Gb	B-die		1				
		M393B5270CH0	CF8/H9		512M x 4 * 18 pcs	2Gb	C-die						
1Gx 72	8GB	M393B1G70EM1	CF8	F(4Rx4)	DDP 512M x 4 * 36 pcs	1Gb	E-die	8	4	78 ball FBGA	30mm	Now	
		M393B1K73BH1	CF8		H(4Rx8)	256M x 8 * 36 pcs	2Gb						
		M393B1K73CH0	CF8/H9	256M x 8 * 36 pcs		2Gb	C-die						
		M393B1K70BH1	CF8/H9	E(2Rx4)		512M x 4 * 36 pcs	2Gb		B-die				
		M393B1K70CH0	CF8/H9		512M x 4 * 36 pcs	2Gb	C-die						
2Gx 72	16GB	M393B2K70BM1	CF8	F(4Rx4)	DDP 1G x 4 * 36 pcs	2Gb	B-die	8	4	78 ball FBGA	30mm	Now	
		M393B2K70CM0	CF8/H9		DDP 1G x 4 * 36 pcs	2Gb	C-die						
		M393B2G70AH0	CF8/H9	E(2Rx4)	1G x 4 * 36 pcs	4Gb	A-die		2				
		M393B2G73AH0	CF8/H9	H(4Rx8)	512M x 8 * 36 pcs	4Gb	A-die						
4Gx 72	32GB	M393B4G70AH0	CF8/H9	AB(4Rx4)	DDP 2G x 4 * 36 pcs	4Gb	A-die	8	4	78 ball FBGA	30mm	Now	

4.6 240Pin DDR3 Registered DIMM (1.35V Product)

240Pin DDR3 Registered DIMM													
Org.	Density	Part Number	Speed	Raw Card	Composition	Comp. Version		Internal Banks	Rank	PKG	Height	Avail.	NOTE
128Mx 72	1GB	M393B2873EH1	YF8/H9	A(1Rx8)	128M x 8 * 9 pcs	1Gb	E-die	8	1	78 ball FBGA	30mm	Now	
		M393B2873FH0	YF8/H9		128M x 8 * 9 pcs	1Gb	F-die						
256Mx 72	2GB	M393B5673EH1	YF8/H9	B(2Rx8)	128M x 8 * 18 pcs	1Gb	E-die	8	2	78 ball FBGA	30mm	Now	
		M393B5673FH0	YF8/H9		128M x 8 * 18 pcs	1Gb	F-die						
		M393B5670EH1	YF8/H9	C(1Rx4)	256M x 4 * 18 pcs	1Gb	E-die	8	1				
		M393B5670FH0	YF8/H9		256M x 4 * 18 pcs	1Gb	F-die						
		M393B5773CH0	YF8/H9	A(1Rx8)	256M x 8 * 9 pcs	2Gb	C-die						
512Mx 72	4GB	M393B5173EH1	YF8	H(4Rx8)	128M x 8 * 36 pcs	1Gb	E-die	8	4	78 ball FBGA	30mm	Now	
		M393B5173FH0	YF8/H9		128M x 8 * 36 pcs	1Gb	F-die						
		M393B5170EH1	YF8/H9	E(2Rx4)	256M x 4 * 36 pcs	1Gb	E-die	8	2				
		M393B5170FH0	YF8/H9		256M x 4 * 36 pcs	1Gb	F-die						
		M393B5273BH1	YF8/H9	B(2Rx8)	256M x 8 * 18 pcs	2Gb	B-die	8	2				
		M393B5273CH0	YF8/H9		256M x 8 * 18 pcs	2Gb	C-die						
		M393B5270BH1	YF8/H9	C(1Rx4)	512M x 4 * 18 pcs	2Gb	B-die	8	1				
		M393B5270CH0	YF8/H9		512M x 4 * 18 pcs	2Gb	C-die						
1Gx 72	8GB	M393B1G70EM1	YF8	F(4Rx4)	DDP 512M x 4 * 36 pcs	1Gb	E-die	8	4	78 ball FBGA	30mm	Now	
		M393B1K73BH1	YF8	H(4Rx8)	256M x 8 * 36 pcs	2Gb	B-die	8	4				
		M393B1K73CH0	YF8/H9		256M x 8 * 36 pcs	2Gb	C-die						
		M393B1K70BH1	YF8/H9	E(2Rx4)	512M x 4 * 36 pcs	2Gb	B-die	8	2				
		M393B1K70CH0	YF8/H9		512M x 4 * 36 pcs	2Gb	C-die						
2Gx 72	16GB	M393B2K70BM1	YF8	F(4Rx4)	DDP 1G x 4 * 36 pcs	2Gb	B-die	8	4	78 ball FBGA	30mm	Now	
		M393B2K70CM0	YF8/H9		DDP 1G x 4 * 36 pcs	2Gb	C-die						
		M393B2G70AH0	YF8/H9	E(2Rx4)	1G x 4 * 36 pcs	4Gb	A-die						
		M393B2G73AH0	YF8/H9	H(4Rx8)	512M x 8 * 36 pcs	4Gb	A-die						
4Gx 72	32GB	M393B4G70AH0	YF8/H9	AB(4Rx4)	DDP 2G x 4 * 36 pcs	4Gb	A-die	8	4	78 ball FBGA	30mm	Now	

* NOTE : 1.35V product is 1.5V operatable.

4.7 240Pin DDR3 VLP Registered DIMM (1.5V Product)

240Pin DDR3 VLP Registered DIMM													
Org.	Density	Part Number	Speed	Raw Card	Composition	Comp. Version		Internal Banks	Rank	PKG	Height	Avail.	NOTE
128Mx 72	1GB	M392B2873EH1	CF8/H9	K(1Rx8)	128M x 8 * 9 pcs	1Gb	E-die	8	1	78 ball FBGA	18.75mm	Now	
		M392B2873FH0	CF8/H9		128M x 8 * 9 pcs	1Gb	F-die						
256Mx 72	2GB	M392B5673EH1	CF8/H9	L(2Rx8)	128M x 8 * 18 pcs	1Gb	E-die	8	2	78 ball FBGA	18.75mm	Now	
		M392B5673FH0	CF8/H9		128M x 8 * 18 pcs	1Gb	F-die						
		M392B5670EH1	CF8/H9	M(1Rx4)	256M x 4 * 18 pcs	1Gb	E-die		1				
		M392B5670FH0	CF8/H9		256M x 4 * 18 pcs	1Gb	F-die						
		M392B5773CH0	CF8/H9		K(1Rx8)	128M x 8 * 9 pcs	1Gb						
512Mx 72	4GB	M392B5170EM1	CF8/H9	N(2Rx4)	DDP 512M x 4 * 18 pcs	1Gb	E-die	8	2	78 ball FBGA	18.75mm	Now	
		M392B5170FM0	CF8/H9		DDP 512M x 4 * 18 pcs	1Gb	F-die						
		M392B5273BH1	CF8/H9	L(2Rx8)	256M x 8 * 18 pcs	2Gb	B-die		2				
		M392B5273CH0	CF8/H9		256M x 8 * 18 pcs	2Gb	C-die						
		M392B5270BH1	CF8/H9	M(1Rx4)	512M x 4 * 18 pcs	2Gb	B-die		1				
		M392B5270CH0	CF8/H9		512M x 4 * 18 pcs	2Gb	C-die						
1Gx 72	8GB	M392B1K73BM1	CF8	V(4Rx8)	DDP 512M x 8 * 18 pcs	2Gb	B-die	8	4	78 ball FBGA	18.75mm	Now	
		M392B1K73CM0	CF8/H9		DDP 512M x 8 * 18 pcs	2Gb	C-die						
		M392B1K70BM1	CF8/H9	N(2Rx4)	DDP 1G x 4 * 18 pcs	2Gb	B-die		2				
		M392B1K70CM0	CF8/H9		DDP 1G x 4 * 18 pcs	2Gb	C-die						
2Gx 72	16GB	M392B2G70AM0	CF8/H9	N(2Rx4)	DDP 2G x 4 * 18 pcs	4Gb	A-die	8	2	78 ball FBGA	18.75mm	Jun.'10	
		M392B2G73AM0	CF8/H9	V(4Rx8)	DDP 1G x 8 * 18 pcs	4Gb	A-die					4	

4.8 240Pin DDR3 VLP Registered DIMM (1.35V Product)

240Pin DDR3 VLP Registered DIMM													
Org.	Density	Part Number	Speed	Raw Card	Composition	Comp. Version		Internal Banks	Rank	PKG	Height	Avail.	NOTE
128Mx 72	1GB	M392B2873EH1	YF8/H9	K(1Rx8)	128M x 8 * 9 pcs	1Gb	E-die	8	1	78 ball FBGA	18.75mm	Now	
		M392B2873FH0	YF8/H9		128M x 8 * 9 pcs	1Gb	F-die						
256Mx 72	2GB	M392B5673EH1	YF8/H9	L(2Rx8)	128M x 8 * 18 pcs	1Gb	E-die	8	2	78 ball FBGA	18.75mm	Now	
		M392B5673FH0	YF8/H9		128M x 8 * 18 pcs	1Gb	F-die						
		M392B5670EH1	YF8/H9	M(1Rx4)	256M x 4 * 18 pcs	1Gb	E-die	8	1				
		M392B5670FH0	YF8/H9		256M x 4 * 18 pcs	1Gb	F-die						
		M392B5773CH0	YF8/H9		K(1Rx8)	512M x 4 * 9 pcs	2Gb						
512Mx 72	4GB	M392B5170EM1	YF8/H9	N(2Rx4)	DDP 512M x 4 * 18 pcs	1Gb	E-die	8	2	78 ball FBGA	18.75mm	Now	
		M392B5170FM0	YF8/H9	N(2Rx4)	512M x 4 * 18 pcs	1Gb	F-die						
		M392B5273BH1	YF8/H9	L(2Rx8)	256M x 8 * 18 pcs	2Gb	B-die	8	2				
		M392B5273CH0	YF8/H9		256M x 8 * 18 pcs	2Gb	C-die						
		M392B5270BH1	YF8/H9	M(1Rx4)	512M x 4 * 18 pcs	2Gb	B-die	8	1				
		M392B5270CH0	YF8/H9		512M x 4 * 18 pcs	2Gb	C-die						
1Gx 72	8GB	M392B1K73BM1	YF8	V(4Rx8)	DDP 512M x 8 * 18 pcs	2Gb	B-die	8	4	78 ball FBGA	18.75mm	Now	
		M392B1K73CM0	YF8		DDP 512M x 8 * 18 pcs	2Gb	C-die						
		M392B1K70BM1	YF8/H9	N(2Rx4)	DDP 1G x 4 * 18 pcs	2Gb	B-die	8	2				
		M392B1K70CM0	YF8/H9		DDP 1G x 4 * 18 pcs	2Gb	C-die						
2Gx 72	16GB	M392B2G70AM0	YF8/H9	N(2Rx4)	DDP 2G x 4 * 18 pcs	4Gb	A-die	8	2	78 ball FBGA	18.75mm	Now	
		M392B2G73AM0	YF8/H9	V(4Rx8)	DDP 1G x 8 * 18 pcs	4Gb	A-die		4			Jun.'10	

* NOTE : 1.35V product is 1.5V operatable.

5. RDIMM RCD Information

5.1 5.1 RCD Identification in JEDEC Description in Module Label

5.2 5.2 Label Example

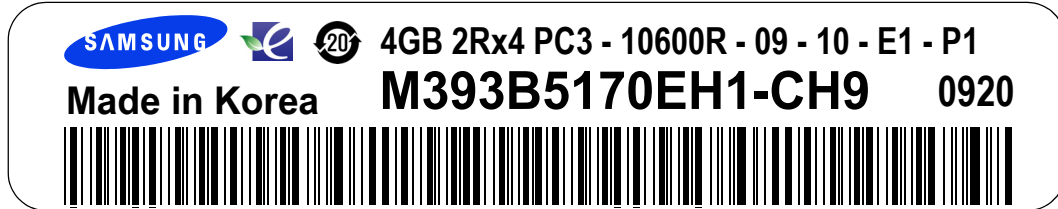

5.3 RCD Information

- Example

Voltage	Vendor	Revision	Module P/N	JEDEC Description On Label
1.5V	Inphi	LV GS02 C0	M393B5170EH1-CH9	4GB 2Rx4 PC3-10600R-09-10-E1-P1
	IDT	LV DDR3 B0	M393B5170EH1-CH9	4GB 2Rx4 PC3-10600R-09-10-E1-D2
1.35V	Inphi	LV GS02 C0	M393B5170EH1-YF8	4GB 2Rx4 PC3L-8500R-07-10-E1-P1
	IDT	LV DDR3 B0	M393B5170EH1-YF8	4GB 2Rx4 PC3L-8500R-07-10-E1-D2

6. Package Dimension

78Ball FBGA for 1Gb E-die (x4/x8) / 1Gb F-die (x4/x8) / 2Gb C-die (x4/x8)

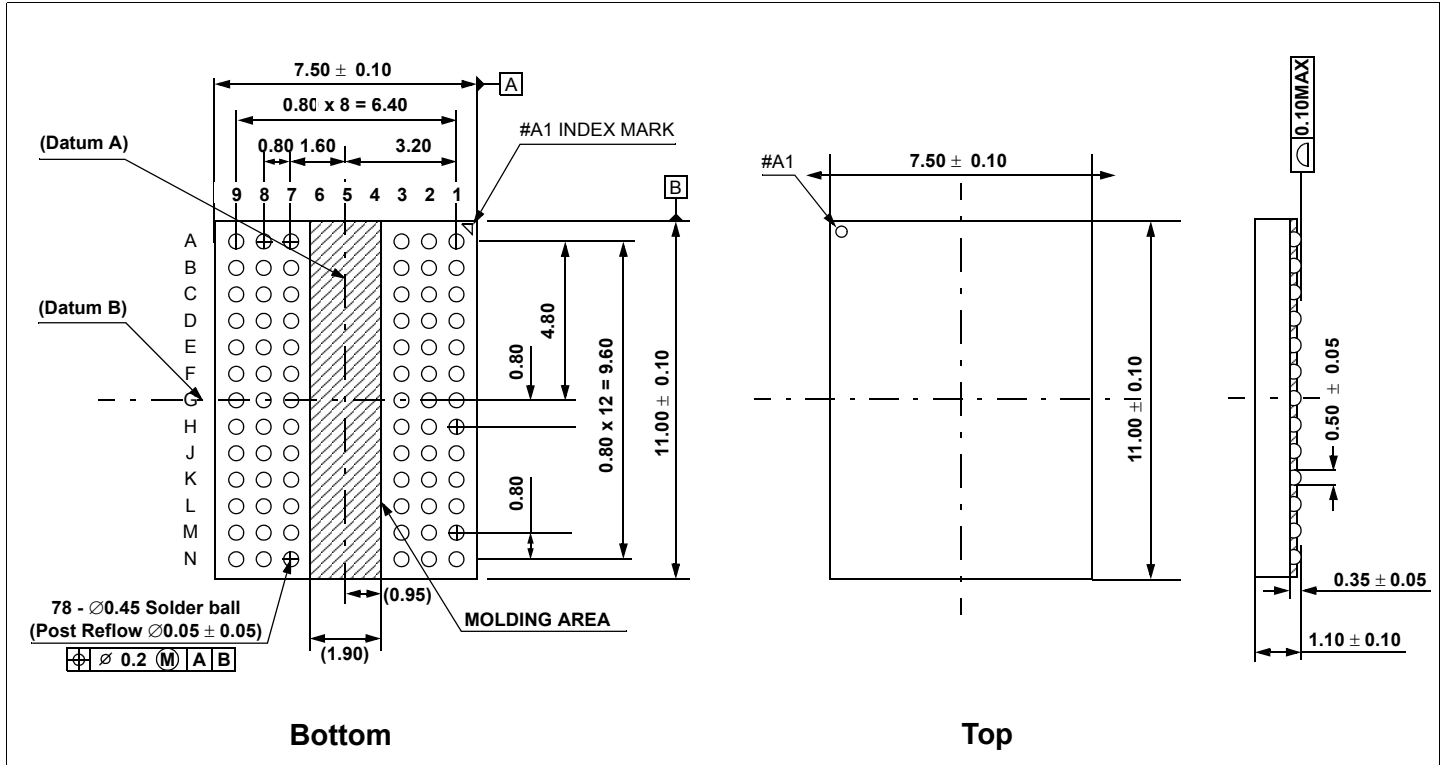

96Ball FBGA for 1Gb E-die (x16)

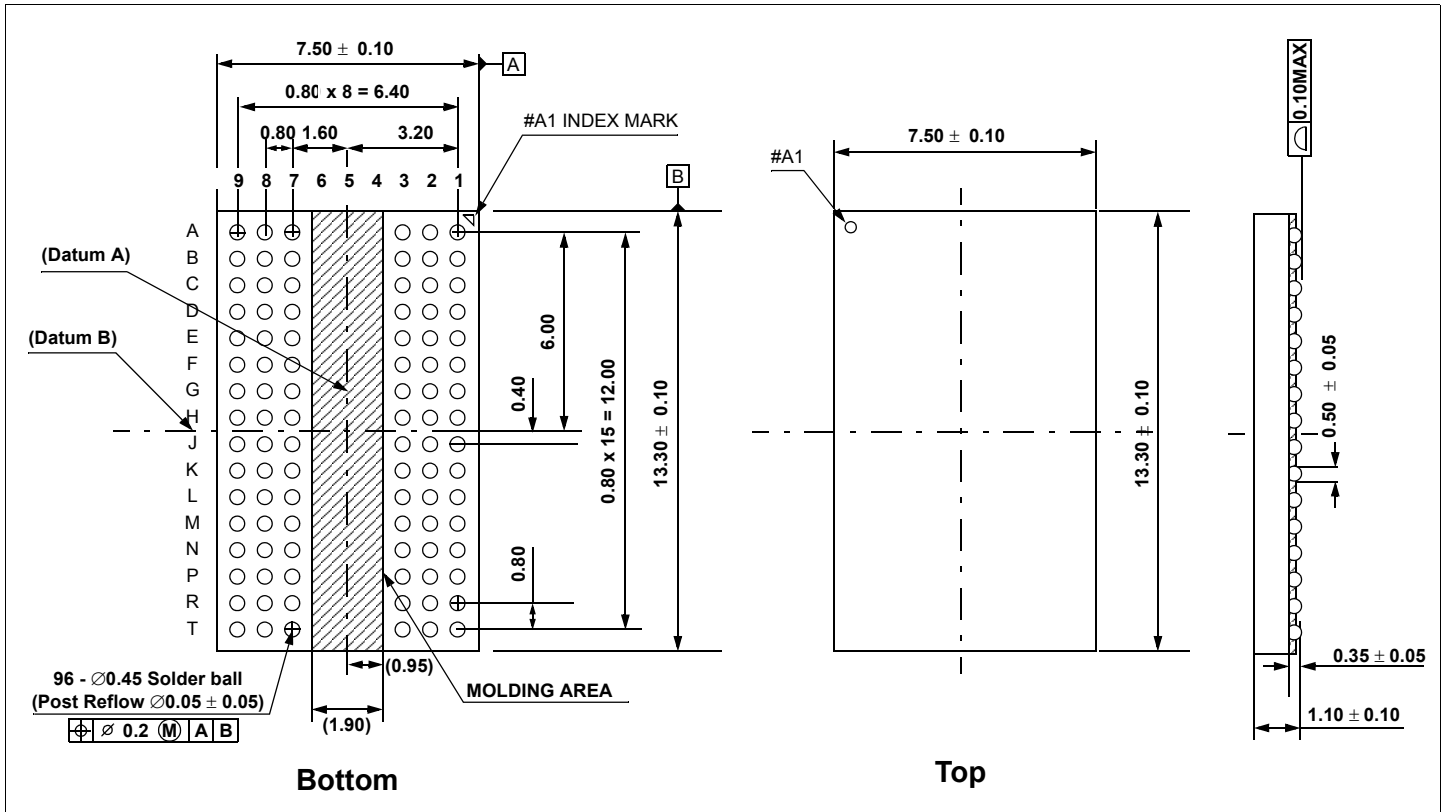

78Ball FBGA for 2Gb B-die (x4/x8)

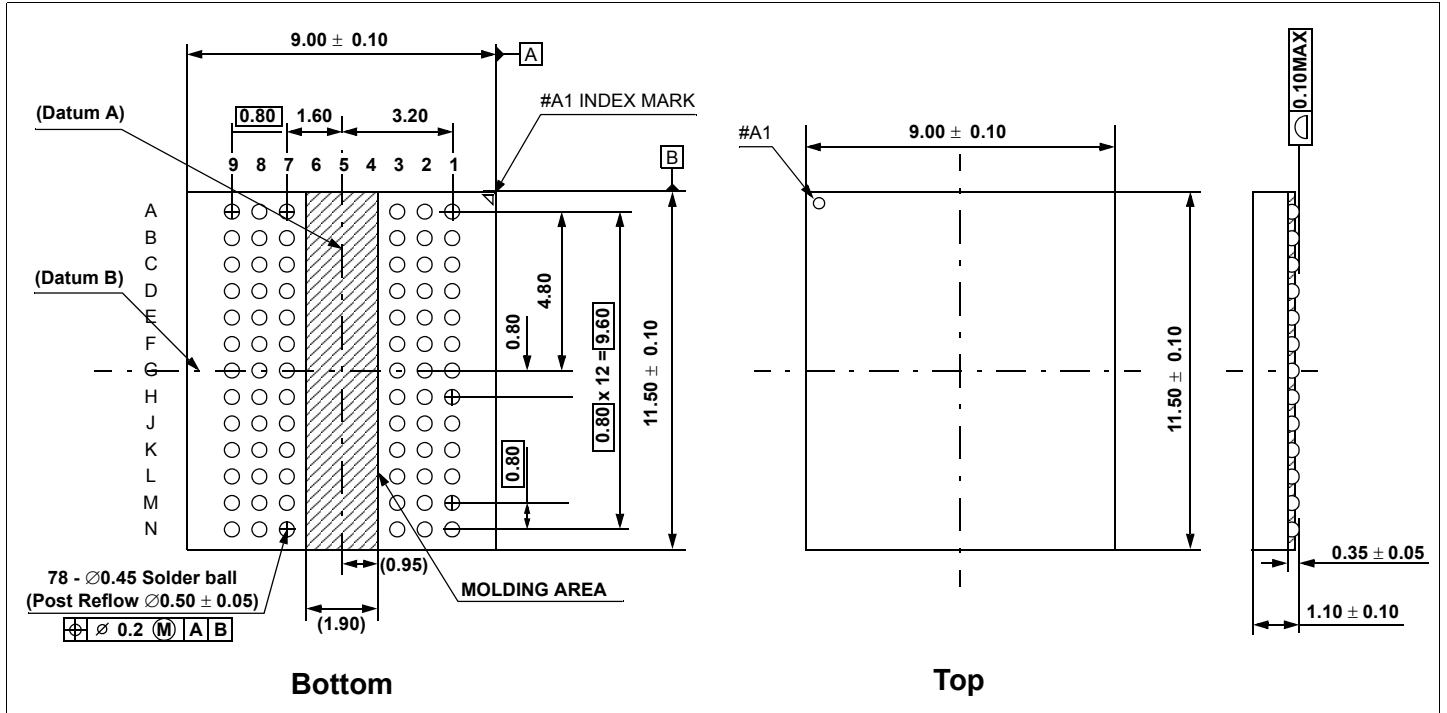

96Ball FBGA for 2Gb B-die (x16)

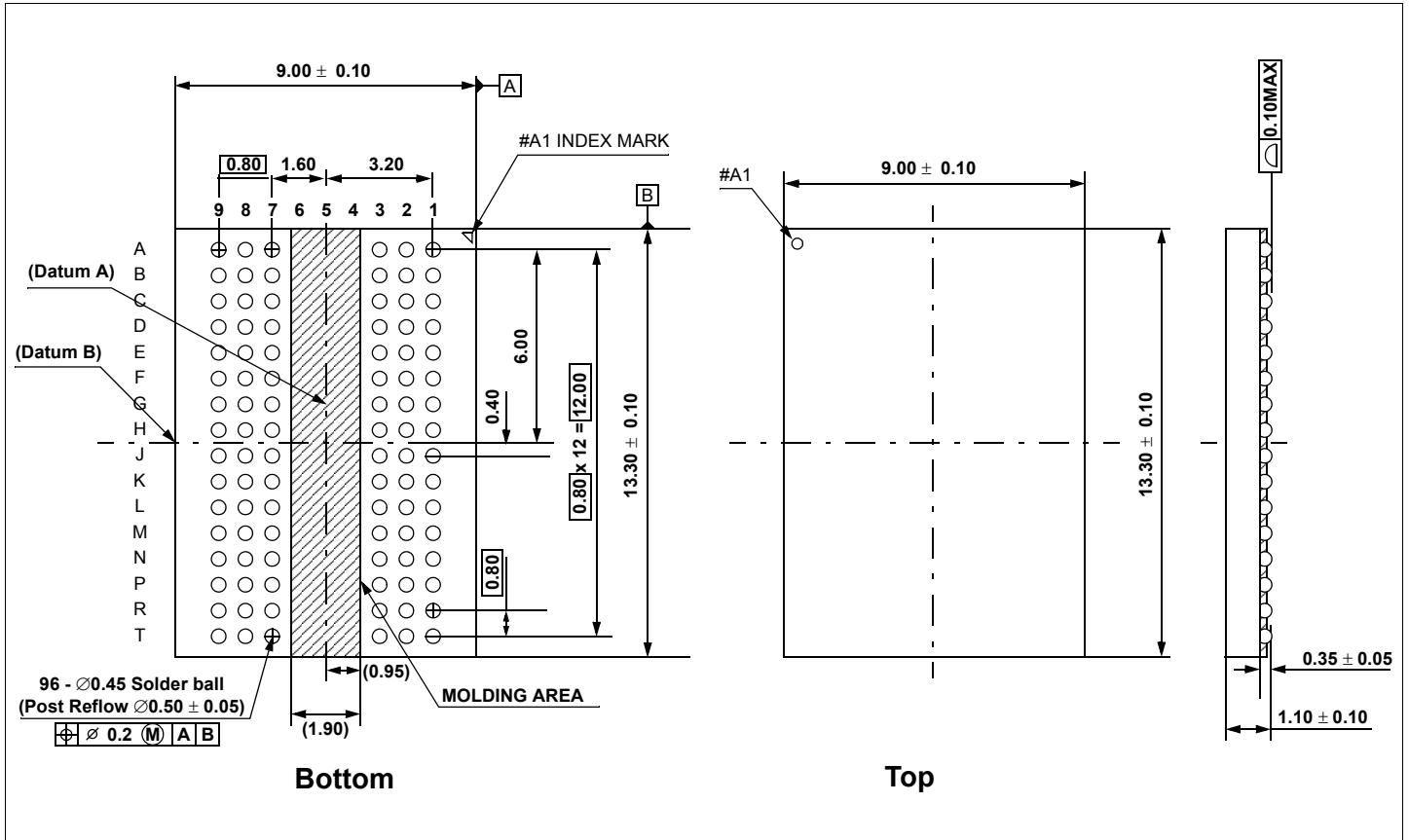

78Ball DDP for 1Gb E-die (x4/x8)

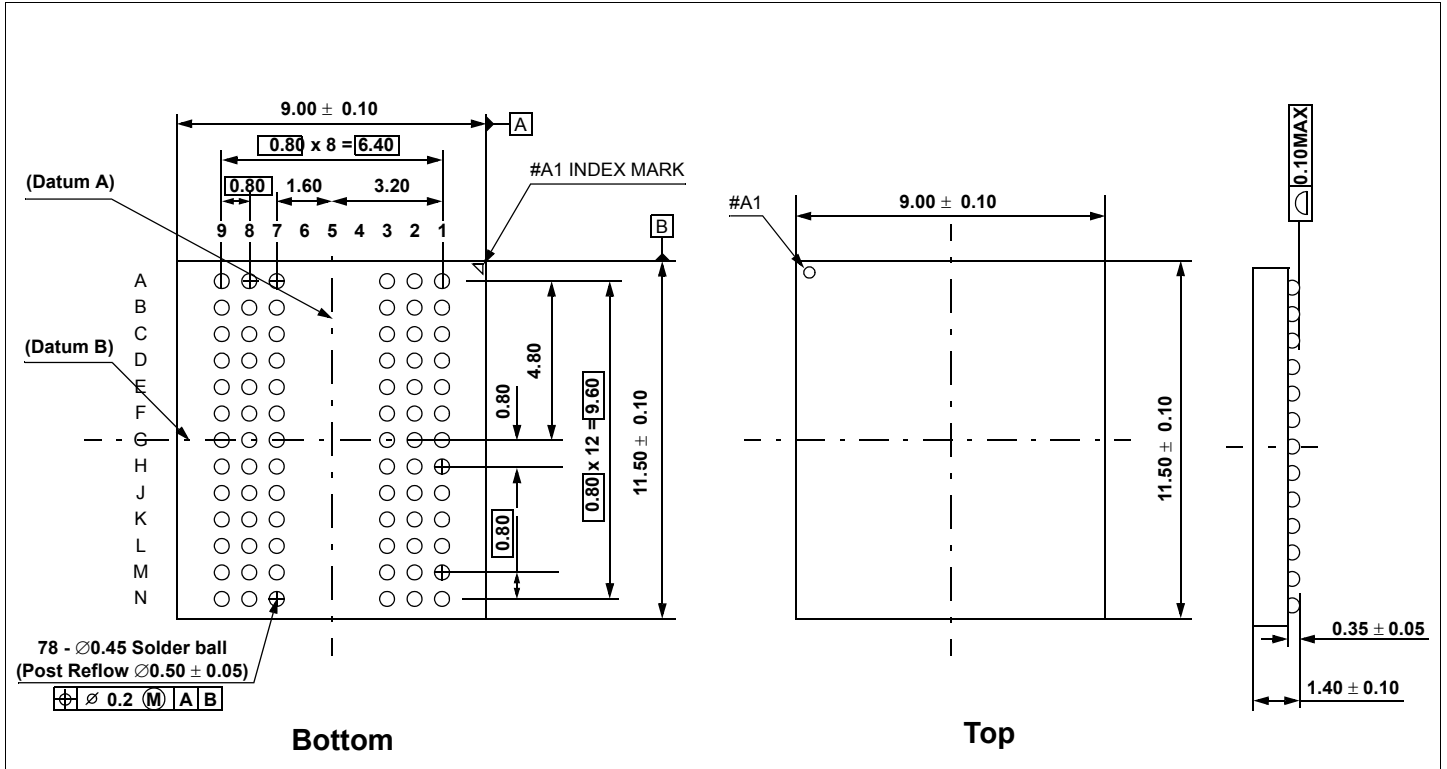

78Ball DDP for 2Gb B-die (x4/x8)

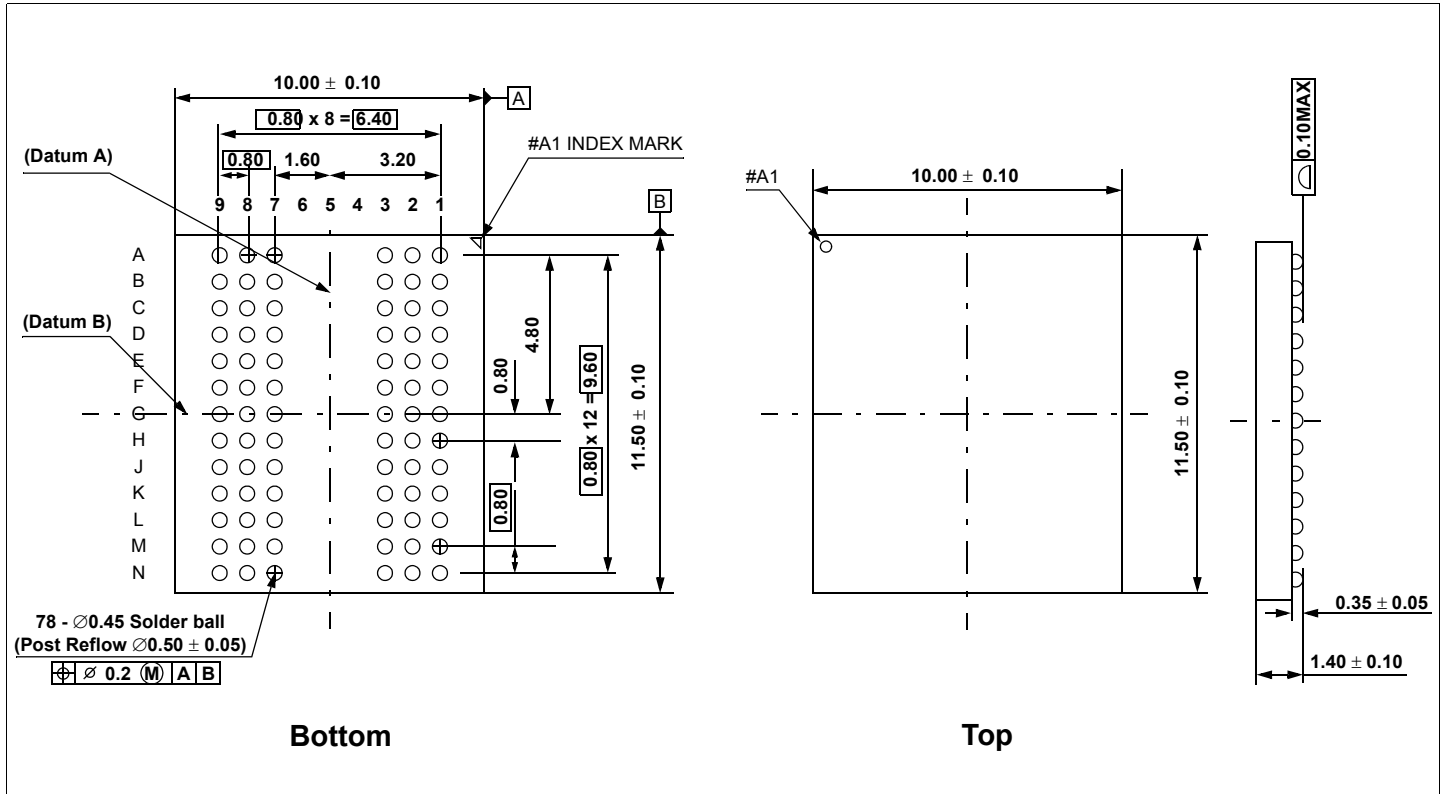

78Ball DDP for 2Gb C-die (x4/x8)

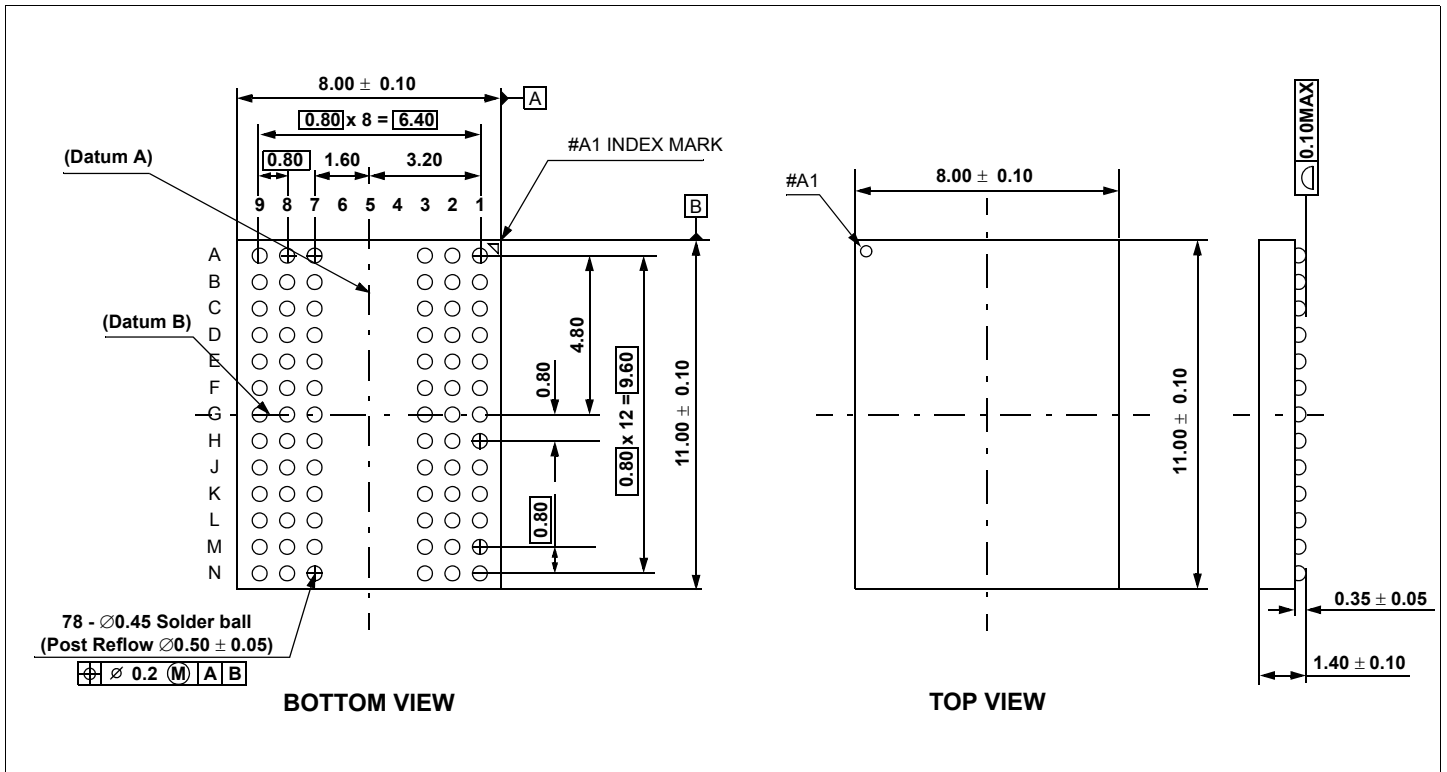

78Ball for 4Gb A-die (x4/x8)

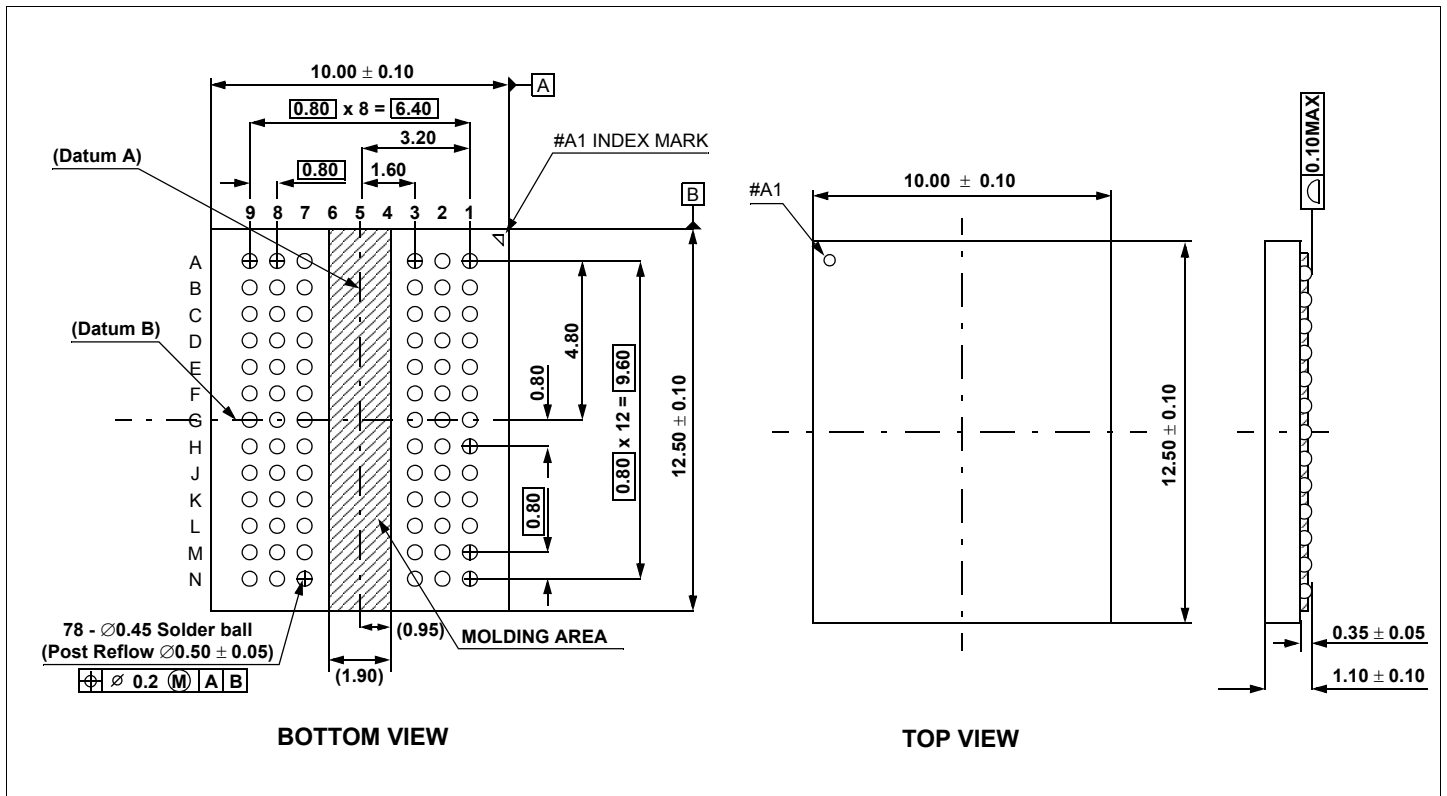

7. Module Dimension

x64/x72 240pin DDR3 SDRAM Unbuffered DIMM

Units : Millimeters

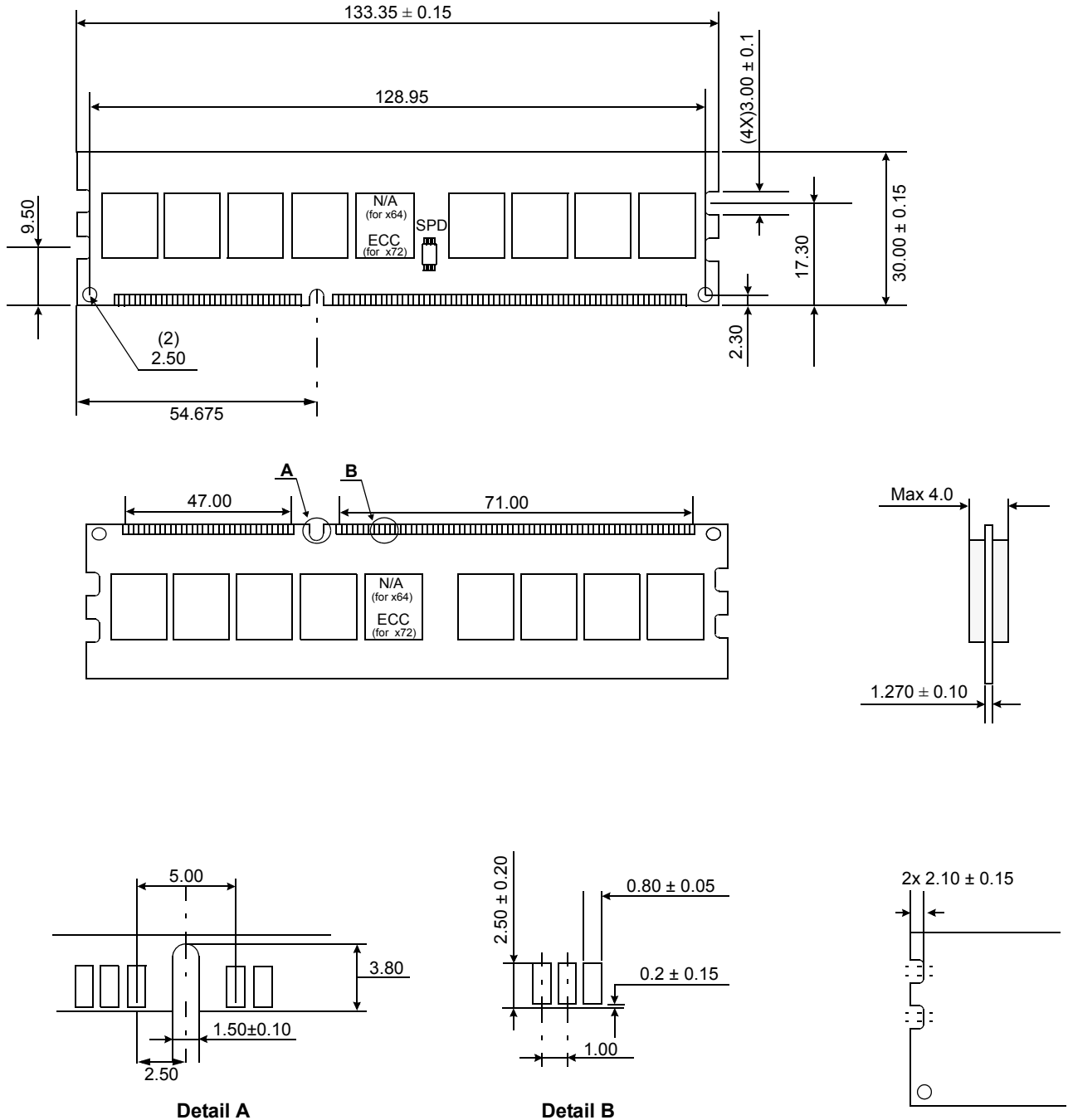

x64 204pin DDR3 SDRAM Unbuffered SODIMM

Units : Millimeters

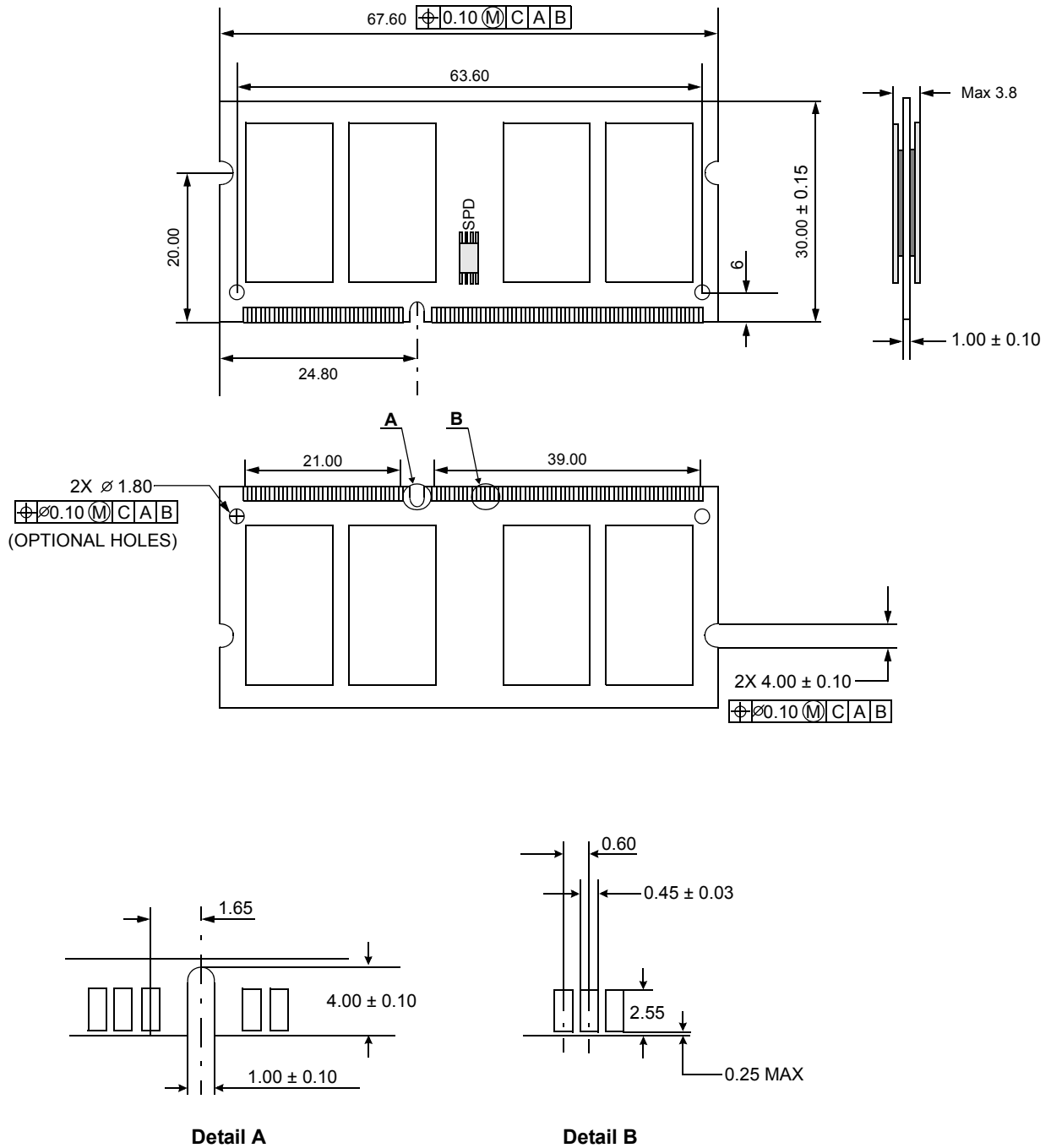

x72 240pin DDR3 SDRAM Registered DIMM

Units : Millimeters

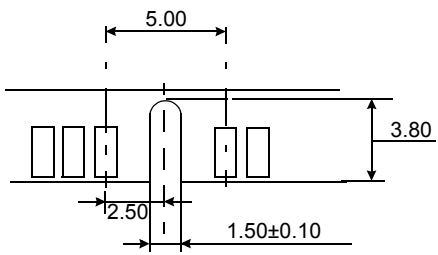
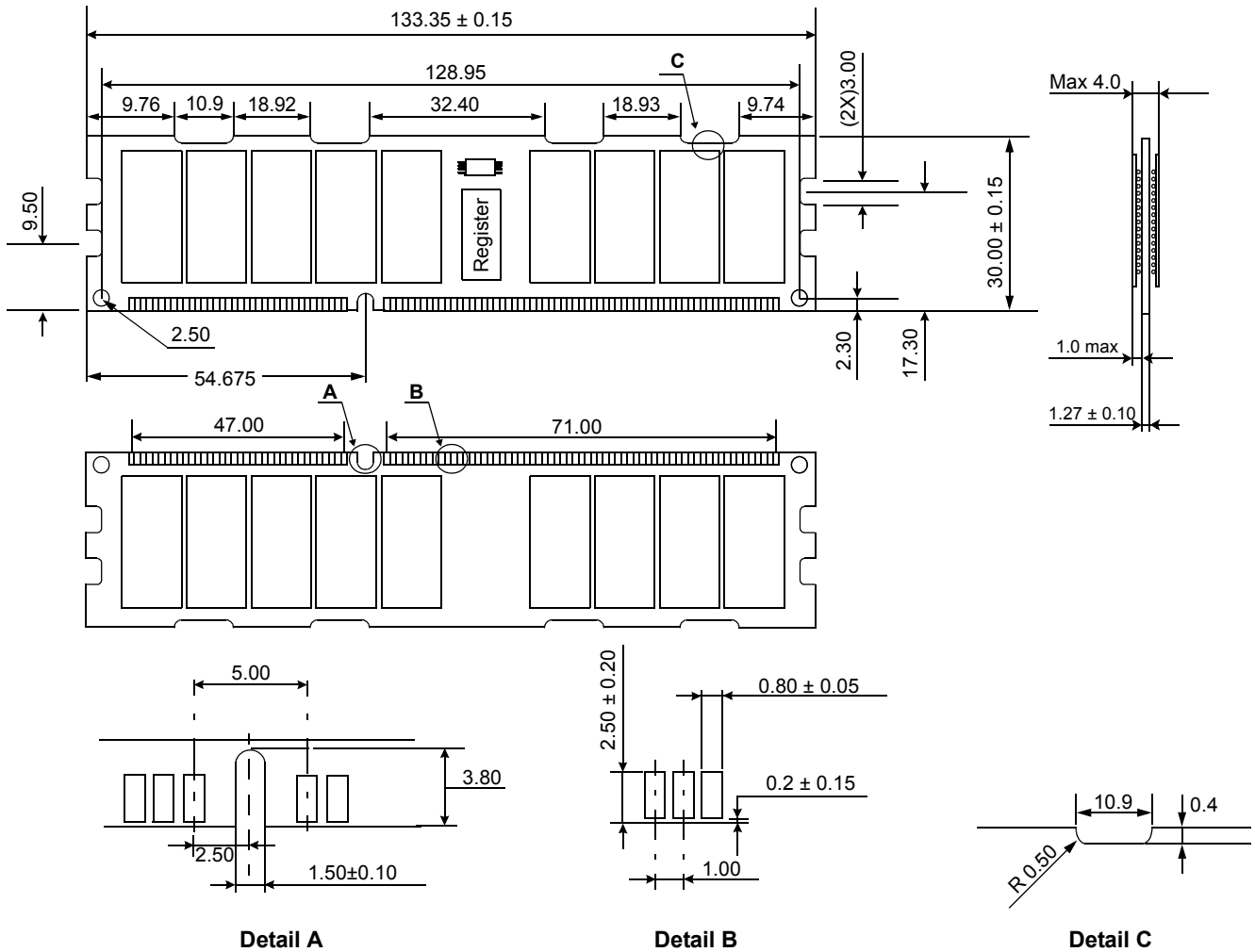

Detail A

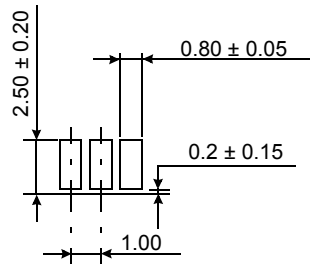

Detail B

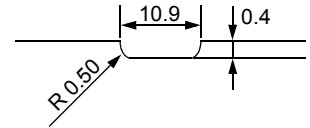

Detail C

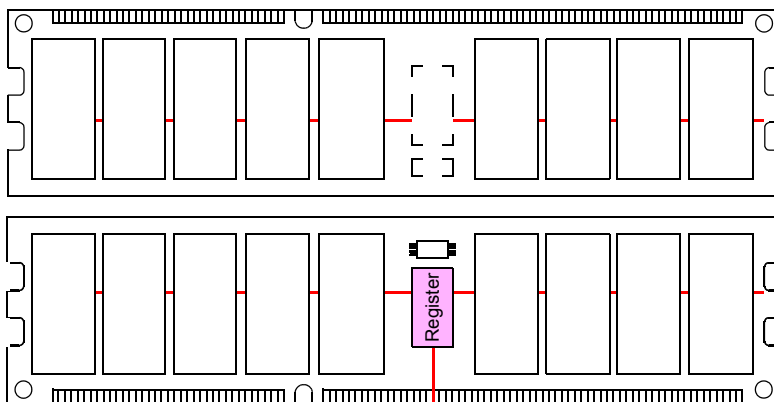

— Address, Command and Control lines

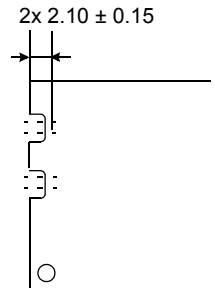

Registered DIMM Heat Spreader Design

1. FRONT PART

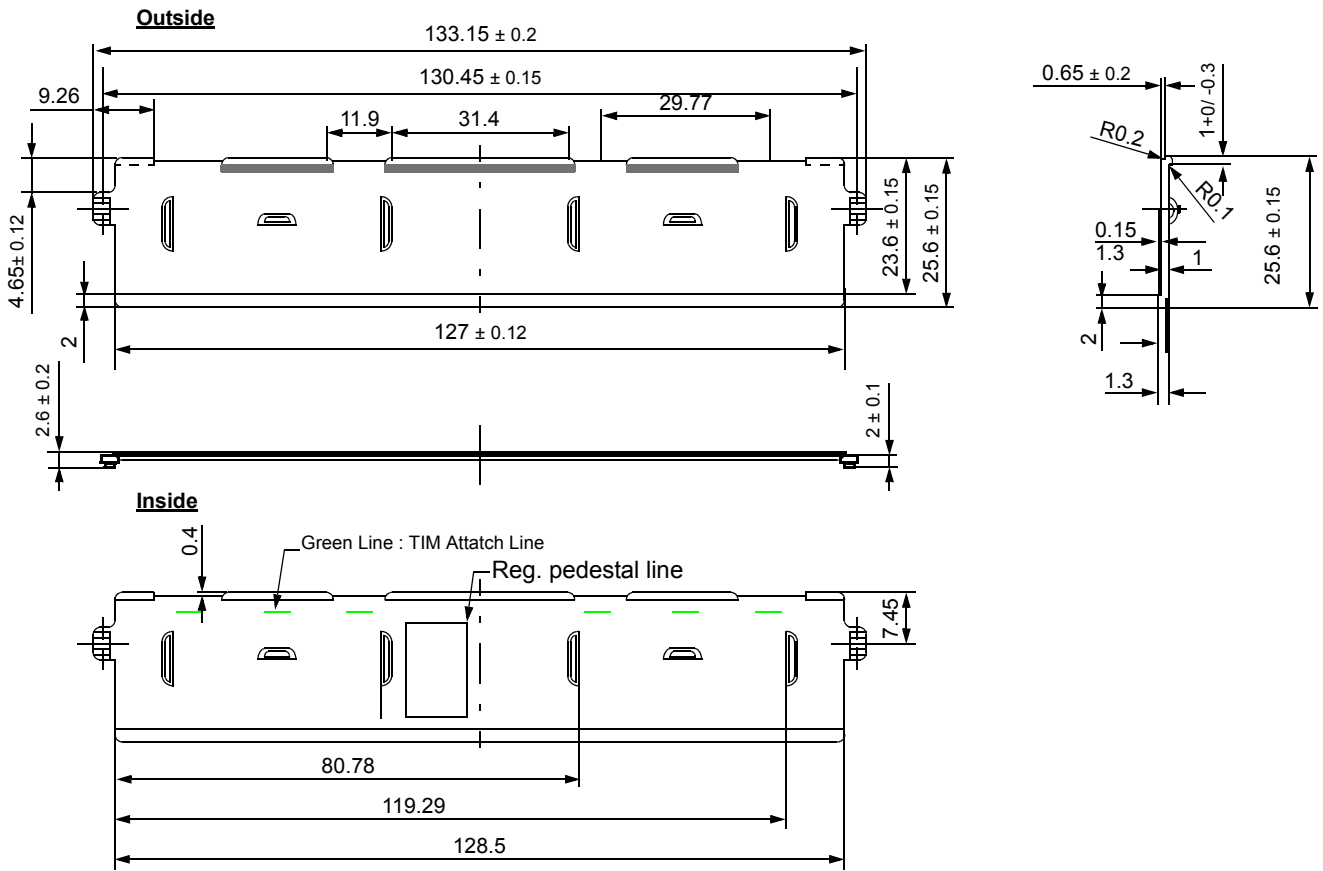

2. BACK PART

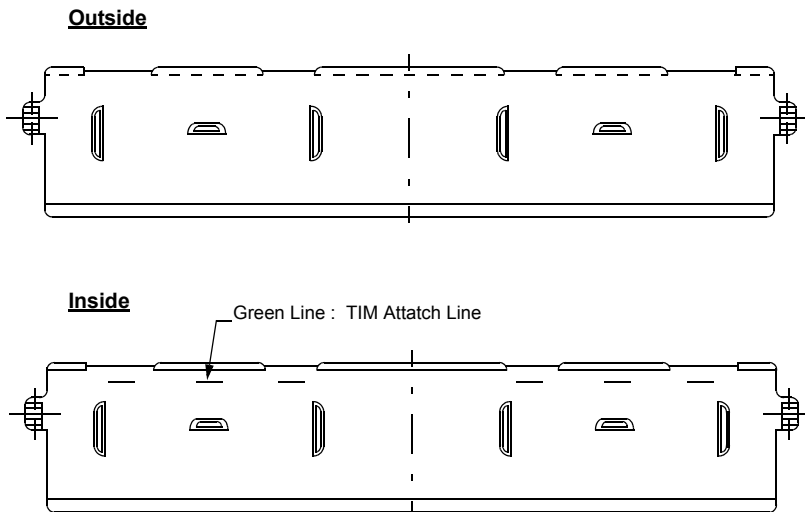

3. CLIP PART

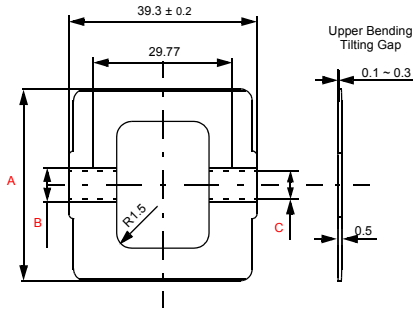

4. DDR3 RDIMM ASS'Y View

Reference thickness total (Maximum) : Mono Package : 7.55mm, DDP Package 7.71mm (With Clip thickness)

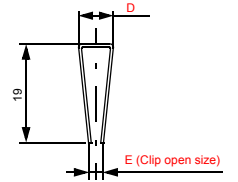
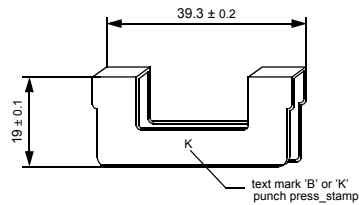
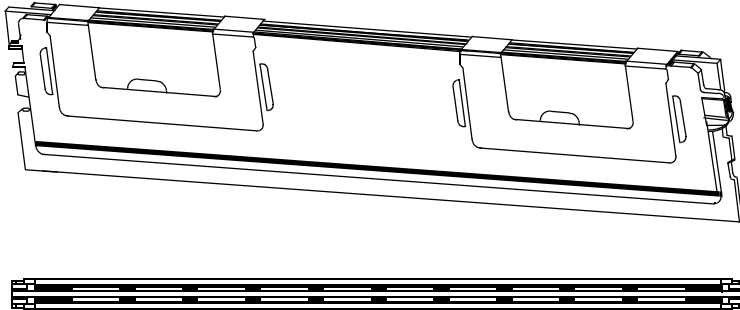
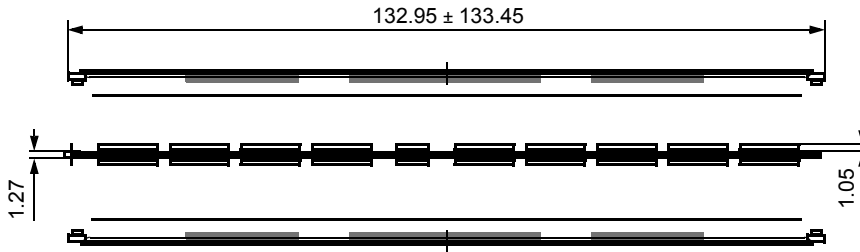

x72 240pin DDR3 SDRAM VLP Registered DIMM

Units : Millimeters

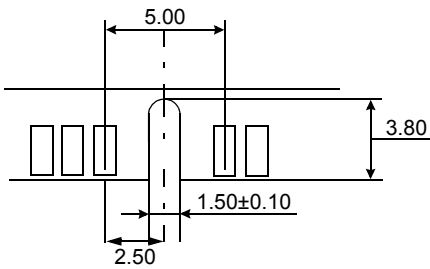
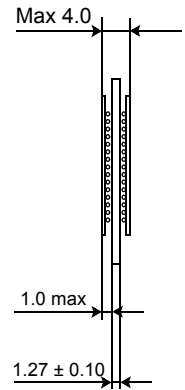
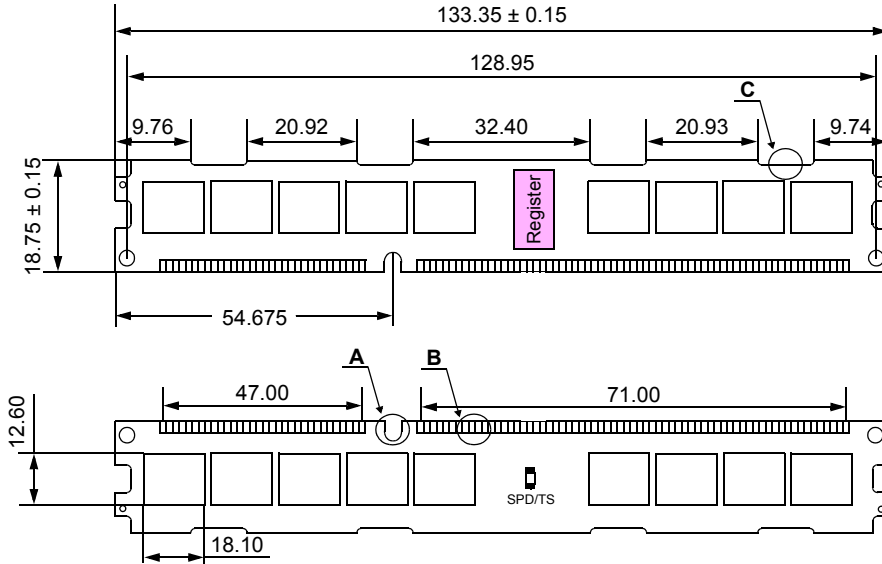

Detail A

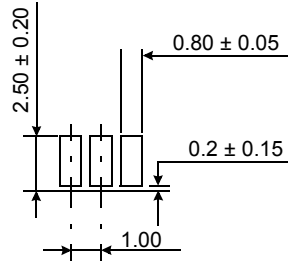

Detail B

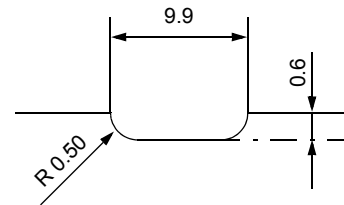

Detail C

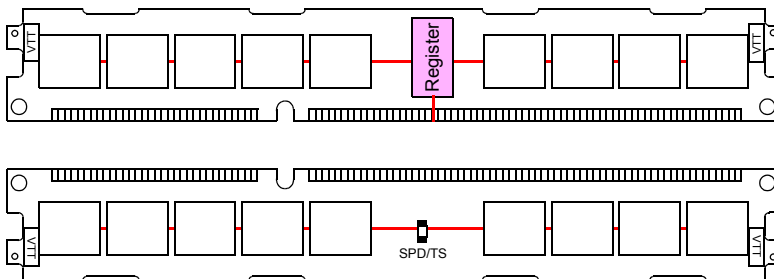

— Address, Command and Control lines

VLP Registered DIMM Heat Spreader Design

1. FRONT PART

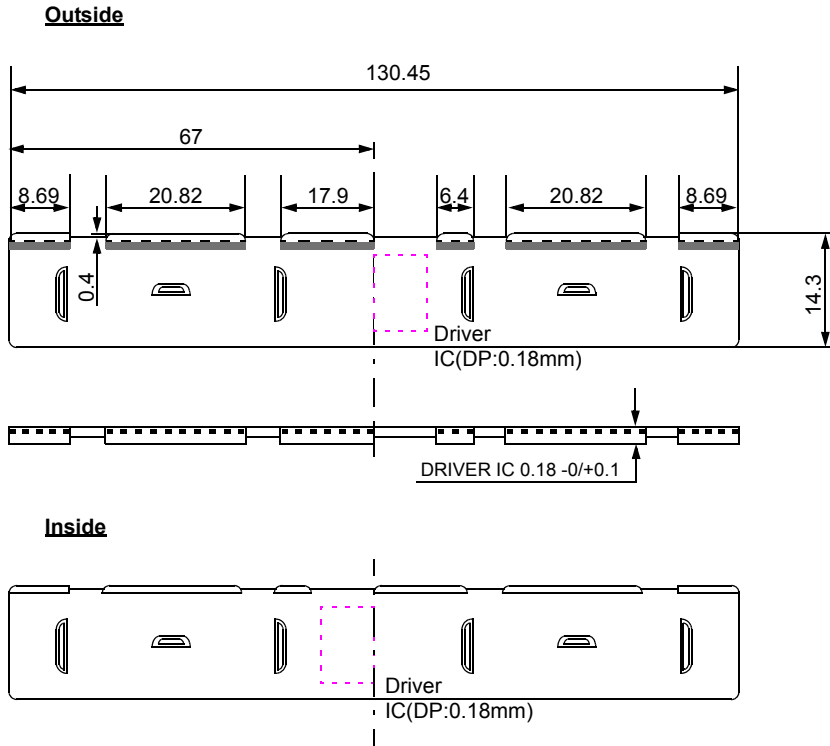

2. BACK PART

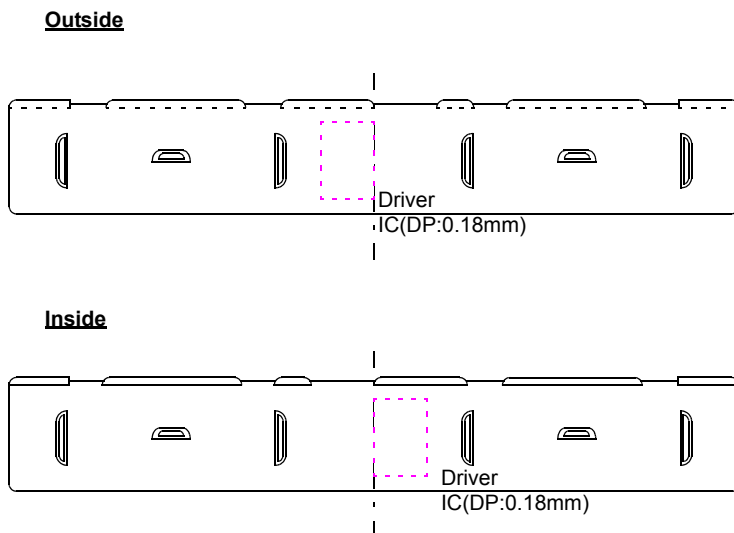

3. CLIP PART

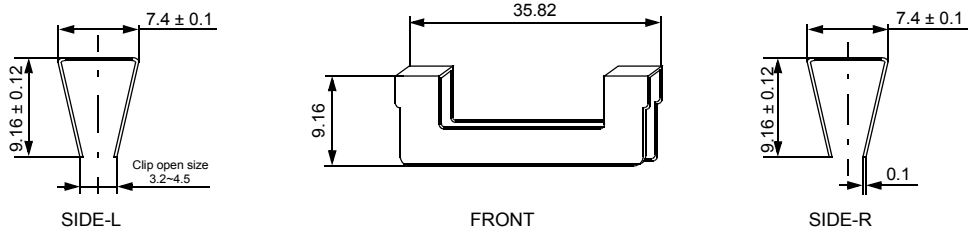

4. ASS'Y VIEW

Reference thickness total (Maximum) : 7.71 (With Clip thickness)

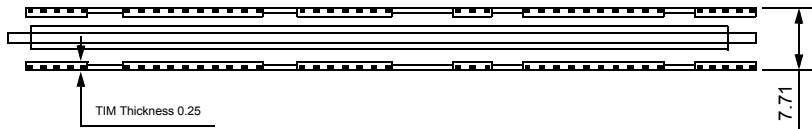

* Dimension Index

	Mono			DDP			Note
	Min.	Typ.	Max.	Min.	Typ.	Max.	
A	-	43.9	-	-	44.4	-	
B	6.7	6.8	6.9	7.2	7.3	7.4	
C	-	5.8	-	-	6.3	-	
D	6.7	6.8	6.9	7.2	7.3	7.4	
E (Clip open size)	2.5	-	3.6	2.6	-	3.8	