

PLEASE CHECK WWW.MOLEX.COM FOR LATEST PART INFORMATION

Part Number: [0039295123](#)
Status: **Active**
Overview: [minifit_jr](#)
Description: 4.20mm (.165") Pitch Mini-Fit Jr.™ Header, Dual Row, Right Angle, with PCB Mounting Flange, 12 Circuits, PA Polyamide Nylon 6/6 94V-2, Gold (Au) Plating

Documents:

[3D Model](#) [RoHS Certificate of Compliance \(PDF\)](#)
[Drawing \(PDF\)](#)

Agency Certification

| | |
|-----|-----------|
| CSA | LR19980 |
| TUV | R72081037 |
| UL | E29179 |

General

| | |
|----------------|---|
| Product Family | PCB Headers |
| Series | 5569 |
| Application | Wire-to-Board |
| Comments | Current = 13A max. per circuit when header is mated to a receptacle loaded with 45750 Mini-Fit Plus HCS™ Crimp Terminal Crimped to to 16 AWG wire. . See Molex product specification PS-45750-001 for additional current de-rating information. |

Overview [minifit_jr](#)
 Product Name Mini-Fit Jr.™

Physical

| | |
|--------------------------------|-------------|
| Breakaway | No |
| Circuits (Loaded) | 12 |
| Circuits (maximum) | 12 |
| Circuits Detail | 12 |
| Color - Resin | Natural |
| Durability (mating cycles max) | 30 |
| First Mate / Last Break | No |
| Flammability | 94V-2 |
| Glow-Wire Compliant | No |
| Guide to Mating Part | No |
| Keying to Mating Part | None |
| Lock to Mating Part | Yes |
| Material - Metal | Brass |
| Material - Plating Mating | Gold |
| Material - Plating Termination | Gold |
| Material - Resin | Nylon |
| Number of Rows | 2 |
| Orientation | Right Angle |
| PCB Locator | Yes |
| PCB Retention | Yes |
| PCB Thickness Recommended (in) | 0.070 In |
| PCB Thickness Recommended (mm) | 1.78 mm |
| Packaging Type | Bag |
| Pitch - Mating Interface (in) | 0.165 In |
| Pitch - Mating Interface (mm) | 4.20 mm |
| Pitch - Term. Interface (in) | 0.165 In |
| Pitch - Term. Interface (mm) | 4.20 mm |
| Polarized to Mating Part | Yes |

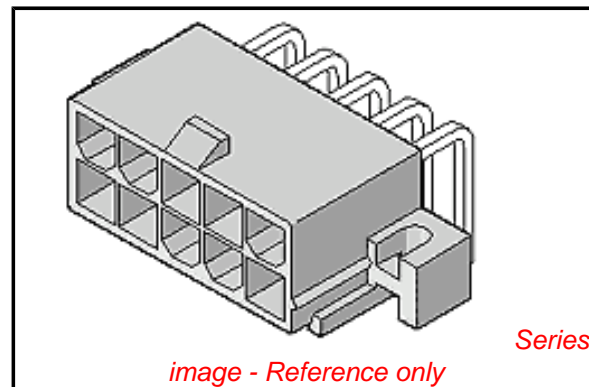

EU RoHS

ELV and RoHS Compliant
REACH SVHC
 Not Reviewed
Halogen-Free Status
Not Reviewed

China RoHS



Need more information on product environmental compliance?

Email productcompliance@molex.com
 For a multiple part number RoHS Certificate of Compliance, [click here](#)

Please visit the [Contact Us](#) section for any non-product compliance questions.

Search Parts in this Series

[5569Series](#)

Mates With

[5557](#) Mini-Fit Jr.™ Receptacle Housing

| | |
|--------------------------------|-----------------|
| Polarized to PCB | Yes |
| Shrouded | Fully |
| Stackable | No |
| Surface Mount Compatible (SMC) | No |
| Temperature Range - Operating | -40°C to +105°C |
| Termination Interface: Style | Through Hole |

Electrical

| | |
|-------------------------------|------|
| Current - Maximum per Contact | 13A |
| Voltage - Maximum | 600V |

Solder Process Data

| | |
|------------------------------|------------------------|
| Lead-free Process Capability | Wave Capable (TH only) |
|------------------------------|------------------------|

Material Info

| | |
|-----------------|------------|
| Old Part Number | 5569-12AG1 |
|-----------------|------------|

Reference - Drawing Numbers

| | |
|-------------------------|-------------|
| Packaging Specification | PK-5569-NA* |
| Sales Drawing | SD-5569-002 |

This document was generated on 05/21/2010

PLEASE CHECK WWW.MOLEX.COM FOR LATEST PART INFORMATION

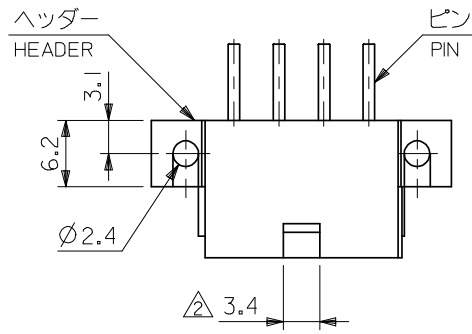

注記

1. 嵌合相手: 5557 シリーズ
MATES WITH: 5557 SERIES
2. 2極の場合のみ本寸法は 4.2
IN CASE OF 2 CIRCUITS HEADER, THIS DIMENSION SHOULD BE 4.2mm.
3. 材料及びメッキ
MATERIAL & FINISH

| ENG. NO. | ヘッダー材料 HEADER MATERIAL | ピン材料 PIN MATERIAL | ピンのメッキ FINISH OF PIN |
|---------------|--------------------------------------|---------------------------|--|
| 5569-NA1 | ナイロン66, UL94V-2 NYLON 66, UL94V-2 | 黄銅 (□1.07) | 銅下地錫メッキ TIN OVER COPPER |
| -NA1-210 | ナイロン66, UL94V-0 NYLON 66, UL94V-0 | | 金 : 0.76μm MIN. GOLD 0.76μm MIN. ニッケル下地 : 1.27μm MIN. OVER NICKEL 1.27μm MIN. |
| -NAG1 | ナイロン66, UL94V-2 NYLON 66, UL94V-2 | BRASS (1.07 SQUARE) | |
| 5569-NAG1-210 | ナイロン66, UL94V-0 NYLON 66, UL94V-0 | | |

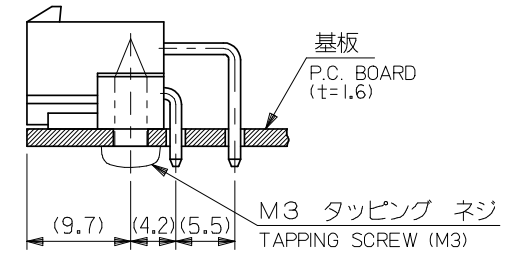
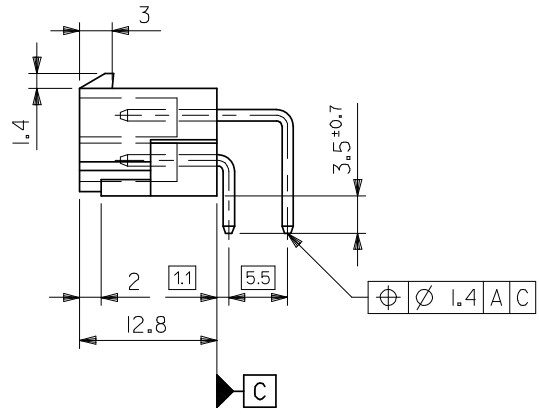
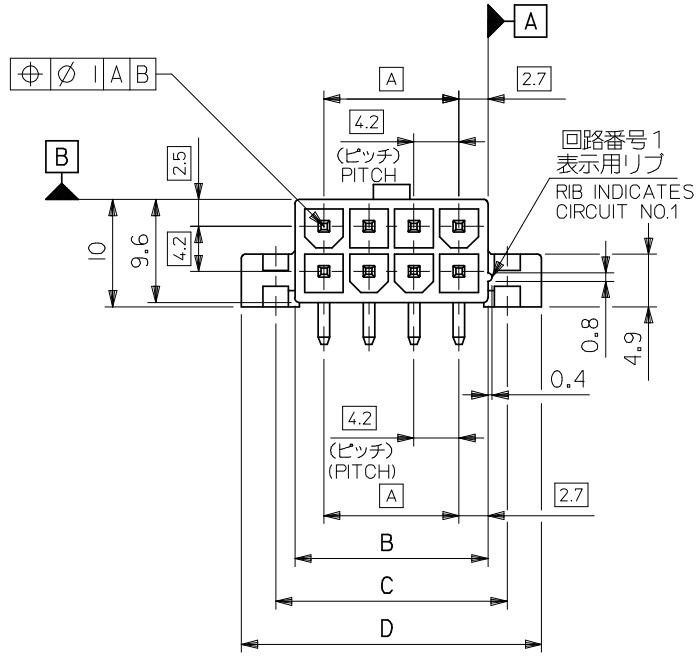

基板取付推奨寸法
RECOMMENDED INSTALLATION PATTERN

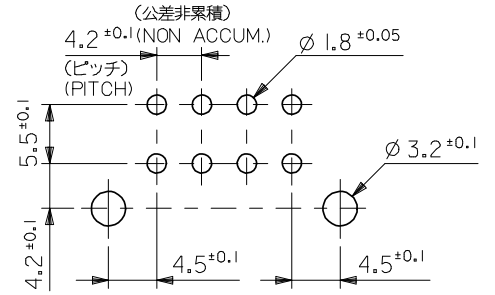

基板穴推奨寸法
RECOMMENDED P.C. BOARD PATTERN

| | | | | |
|------|------|------|------|---------------|
| 61.6 | 55.2 | 51.6 | 46.2 | 24 |
| 57.4 | 51 | 47.4 | 42 | 22 |
| 53.2 | 46.8 | 43.2 | 37.8 | 20 |
| 49 | 42.6 | 39 | 33.6 | 18 |
| 44.8 | 38.4 | 34.8 | 29.4 | 16 |
| 40.6 | 34.2 | 30.6 | 25.2 | 14 |
| 36.4 | 30 | 26.4 | 21 | 12 |
| 32.2 | 25.8 | 22.2 | 16.8 | 10 |
| 28 | 21.6 | 18 | 12.6 | 8 |
| 23.8 | 17.4 | 13.8 | 8.4 | 6 |
| 19.6 | 13.2 | 9.6 | 4.2 | 4 |
| 15.4 | 9 | 5.4 | — | 2 |
| D | C | B | A | 極数 CIRCUIT |

| | | | | | | | | |
|---|--|-----------|----------------------------|--|--|------------------------|---------------------------|--|
| REVISED EC NO: J2008-3781 DRWN: NABEI 2008/05/12 CHKD: MISOGAYA 2008/05/12 APPR: NUKITA 2008/05/12 REV J | GENERAL TOLERANCES (UNLESS SPECIFIED) | | DIMENSION STYLE MM ONLY | | SCALE 2:1 | DESIGN UNITS METRIC | THIRD ANGLE PROJECTION | |
| | 10 UNDER | ±0.2 | DRAWN BY | DATE | TITLE | | | |
| | 10 OVER 30 UNDER | ±0.3 | CHECKED BY | DATE | NEW MINI FIT CONN R/A HEADER ASSY WITH FLANGE | | | |
| | 30 OVER | ±0.4 | APPROVED BY | DATE | MOLEX INCORPORATED | | | |
| | ANGULAR | ±3° | MATERIAL NO. | DOCUMENT NO. | SD-5569-002 | | | |
| DRAFT WHERE APPLICABLE MUST REMAIN WITHIN DIMENSIONS | | SEE TABLE | | THIS DRAWING CONTAINS INFORMATION THAT IS PROPRIETARY TO MOLEX INCORPORATED AND SHOULD NOT BE USED WITHOUT WRITTEN PERMISSION | | SHEET NO. 1 OF 2 | | |

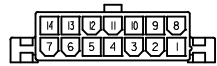

14極
14 CKTS.

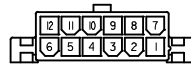

12極
12 CKTS.

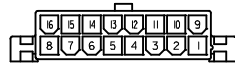

16極
16 CKTS.

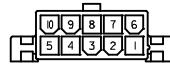

10極
10 CKTS.

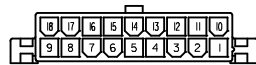

18極
18 CKTS.

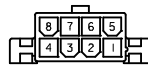

8極
8 CKTS.

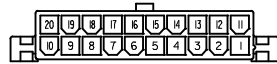

20極
20 CKTS.

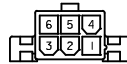

6極
6 CKTS.

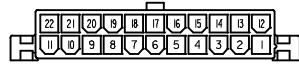

22極
22 CKTS.

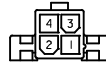

4極
4 CKTS.

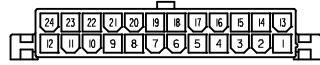

24極
24 CKTS.



2極
2 CKTS.

極数別レイアウト図
CIRCUIT SIZE LAYOUT
(SCALE 1:1)

| | | | | |
|---------------|----------------|--------------|---------------|---------|
| 39-29-4249 | 5569-24AG1-210 | 39-29-1247 | 5569-24A1-210 | 24 |
| ▲ -4229 | ▲ -22AG1-210 | ▲ -1227 | ▲ -22A1-210 | 22 |
| -4209 | -20AG1-210 | -1207 | -20A1-210 | 20 |
| -4189 | -18AG1-210 | -1187 | -18A1-210 | 18 |
| -4169 | -16AG1-210 | -1167 | -16A1-210 | 16 |
| -4149 | -14AG1-210 | -1147 | -14A1-210 | 14 |
| -4129 | -12AG1-210 | -1127 | -12A1-210 | 12 |
| -4109 | -10AG1-210 | -1107 | -10A1-210 | 10 |
| -4089 | -08AG1-210 | -1087 | -08A1-210 | 8 |
| -4069 | -06AG1-210 | -1067 | -06A1-210 | 6 |
| ▼ -4049 | ▼ -04AG1-210 | ▼ -1047 | ▼ -04A1-210 | 4 |
| 39-29-4029 | 5569-02AG1-210 | 39-29-1027 | 5569-02A1-210 | 2 |
| EDP NO. | ENG. NO. | EDP NO. | ENG. NO. | 極数 |
| 5569-NAG1-210 | | 5569-NA1-210 | | CIRCUIT |
| 39-29-5243 | 5569-24AG1 | 39-29-1248 | 5569-24A1 | 24 |
| ▲ -5223 | ▲ -22AG1 | ▲ -1228 | ▲ -22A1 | 22 |
| -5203 | -20AG1 | -1208 | -20A1 | 20 |
| -5183 | -18AG1 | -1188 | -18A1 | 18 |
| -5163 | -16AG1 | -1168 | -16A1 | 16 |
| -5143 | -14AG1 | -1148 | -14A1 | 14 |
| -5123 | -12AG1 | -1128 | -12A1 | 12 |
| -5103 | -10AG1 | -1108 | -10A1 | 10 |
| -5083 | -08AG1 | -1088 | -08A1 | 8 |
| -5063 | -06AG1 | -1068 | -06A1 | 6 |
| ▼ -5043 | ▼ -04AG1 | ▼ -1048 | ▼ -04A1 | 4 |
| 39-29-5023 | 5569-02AG1 | 39-29-1028 | 5569-02A1 | 2 |
| EDP NO. | ENG. NO. | EDP NO. | ENG. NO. | 極数 |
| 5569-NAG1 | | 5569-NA1 | | CIRCUIT |

| | | | | | | | |
|--|---------------------------------------|---|----------------------------|-------------------|--|------------------------|------------------------|
| REVISED EC NO.: J2008-3781 DRWN:MMABEI 2008/05/12 CHKD:MI SOGAYA 2008/05/12 APPR:NUKITA 2008/05/12 | GENERAL TOLERANCES (UNLESS SPECIFIED) | | DIMENSION STYLE MM ONLY | | SCALE 2:1 | DESIGN UNITS METRIC | THIRD ANGLE PROJECTION |
| | 10 UNDER | ±0.2 | DRAWN BY H.HIRAMOTO | DATE '90/04/23 | TITLE NEW MINI FIT CONN R/A HEADER ASSY WITH FLANGE | | |
| | 10 OVER 30 UNDER | ±0.3 | CHECKED BY M.FUKUSHIMA | DATE '91/07/04 | | | |
| | 30 OVER | ±0.4 | APPROVED BY M.ONOMOTO | DATE '91/07/04 | MOLEX INCORPORATED DOCUMENT NO. SD-5569-002 SHEET NO. 2 OF 2 | | |
| ANGULAR ±3 ° | | MATERIAL NO. SEE TABLE | | | | | |
| DRAFT WHERE APPLICABLE MUST REMAIN WITHIN DIMENSIONS | | THIS DRAWING CONTAINS INFORMATION THAT IS PROPRIETARY TO MOLEX INCORPORATED AND SHOULD NOT BE USED WITHOUT WRITTEN PERMISSION | | | | | |