

FODM8061

High Noise Immunity, 3.3V/5V, 10Mbit/sec Logic Gate Output (Open Collector) Optocoupler

Features

- High Noise Immunity characterized by common mode transient immunity (CMTi)
 - 20kV/μs Minimum CMTi
- High Speed
 - 10Mbit/sec Data Rate (NRZ)
 - 80ns max. Propagation Delay
 - 25ns max. Pulse Width Distortion
 - 40ns max. Propagation Delay Skew
- 3.3V LVTTTL/LVCMOS Compatibility
- Specifications guaranteed over 3V to 5.5V supply voltage and -40°C to +110°C temperature range
- Safety and regulatory approvals
 - UL1577, 3750 VAC_{RMS} for 1 min.
 - IEC60747-5-2 (pending approval)

Applications

- Microprocessor system interface
 - SPI, I²C
- Industrial fieldbus communications
 - DeviceNet, CAN, RS485
- Programmable logic control
- Isolated data acquisition system
- Voltage level translator
- Isolating MOSFET/IGBT gate drivers

Description

The FODM8061 is a 3.3V/5V high-speed logic gate output (open collector) optocoupler, which supports isolated communications allowing digital signals to communicate between systems without conducting ground loops or hazardous voltages. It utilizes Fairchild's patented coplanar packaging technology, Optoplanar®, and optimized IC design to achieve high noise immunity, characterized by high common mode transient immunity specifications.

This optocoupler consists of an AlGaAs LED at the input, optically coupled to a high speed integrated photo-detector logic gate. The output of the detector IC is an open collector schottky-clamped transistor. The coupled parameters are guaranteed over the wide temperature range of -40°C to +110°C. A maximum input signal of 5mA will provide a minimum output sink current of 13mA (fan out of 8).

Related Resources

- www.fairchildsemi.com/products/opto/
- www.fairchildsemi.com/pf/FO/FODM611.html
- www.fairchildsemi.com/pf/FO/FODM8071.html

Functional Schematic

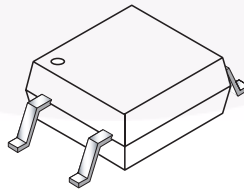
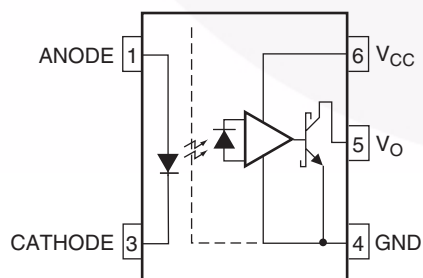

Truth Table

| LED | Output |
|-----|--------|
| Off | High |
| On | Low |

Pin Definitions

| Number | Name | Function Description |
|--------|-----------------|-----------------------|
| 1 | ANODE | Anode |
| 3 | CATHODE | Cathode |
| 4 | GND | Output Ground |
| 5 | V _O | Output Voltage |
| 6 | V _{CC} | Output Supply Voltage |

Safety and Insulation Ratings for Mini-Flat Package (SO5 Pin)

As per IEC60747-5-2 (Pending Certification). This optocoupler is suitable for “safe electrical insulation” only within the safety limit data. Compliance with the safety ratings shall be ensured by means of protective circuits.

| Symbol | Parameter | Min. | Typ. | Max. | Unit |
|-------------------|--|-----------------|-----------|------|-------------------|
| | Installation Classifications per DIN VDE 0110/1.89 Table 1 | | | | |
| | For rated main voltage < 150Vrms | | I-IV | | |
| | For rated main voltage < 300Vrms | | I-III | | |
| | Climatic Classification | | 40/110/21 | | |
| | Pollution Degree (DIN VDE 0110/1.89) | | 2 | | |
| CTI | Comparative Tracking Index | 175 | | | |
| V _{PR} | Input to Output Test Voltage, Method b, V _{IORM} x 1.875 = V _{PR} , 100% Production Test with t _m = 1 sec, Partial Discharge < 5 pC | 1060 | | | |
| V _{PR} | Input to Output Test Voltage, Method a, V _{IORM} x 1.5 = V _{PR} , Type and Sample Test with t _m = 60 sec, Partial Discharge < 5 pC | 848 | | | |
| V _{IORM} | Max Working Insulation Voltage | 565 | | | V _{peak} |
| V _{IOTM} | Highest Allowable Over Voltage | 4000 | | | V _{peak} |
| | External Creepage | 5.0 | | | mm |
| | External Clearance | 5.0 | | | mm |
| | Insulation thickness | 0.5 | | | mm |
| T _{Case} | Safety Limit Values, Maximum Values allowed in the event of a failure, Case Temperature | 150 | | | °C |
| R _{IO} | Insulation Resistance at T _S , V _{IO} = 500V | 10 ⁹ | | | Ω |

Absolute Maximum Ratings ($T_A=25^\circ\text{C}$ unless otherwise specified)

Stresses exceeding the absolute maximum ratings may damage the device. The device may not function or be operable above the recommended operating conditions and stressing the parts to these levels is not recommended. In addition, extended exposure to stresses above the recommended operating conditions may affect device reliability. The absolute maximum ratings are stress ratings only.

| Symbol | Parameter | Value | Units |
|-----------|--|----------------------|------------------|
| T_{STG} | Storage Temperature | -40 to +125 | $^\circ\text{C}$ |
| T_{OPR} | Operating Temperature | -40 to +110 | $^\circ\text{C}$ |
| T_J | Junction Temperature | -40 to +125 | $^\circ\text{C}$ |
| T_{SOL} | Lead Solder Temperature (Refer to Reflow Temperature Profile) | 260 for 10sec | $^\circ\text{C}$ |
| I_F | Forward Current | 50 | mA |
| V_R | Reverse Voltage | 5.0 | V |
| V_{CC} | Supply Voltage | 0 to 7.0 | V |
| V_O | Output Voltage | -0.5 to $V_{CC}+0.5$ | V |
| I_O | Average Output Current | 50 | mA |
| PD_I | Input Power Dissipation ⁽¹⁾⁽²⁾ | 100 | mW |
| PD_O | Output Power Dissipation ⁽¹⁾⁽²⁾ | 85 | mW |

Recommended Operating Conditions

The Recommended Operating Conditions table defines the conditions for actual device operation. Recommended operating conditions are specified to ensure optimal performance to the datasheet specifications. Fairchild does not recommend exceeding them or designing to Absolute Maximum Ratings.

| Symbol | Parameter | Min. | Max. | Unit |
|------------------|---|------|------|------------------|
| T_A | Ambient Operating Temperature | -40 | +110 | $^\circ\text{C}$ |
| V_{CC}, V_{DD} | Supply Voltages ⁽³⁾ | 3.0 | 5.5 | V |
| V_{FL} | Logic Low Input Voltage | 0 | 0.8 | V |
| I_{FH} | Logic High Input Current ⁽⁴⁾ | 6.3 | 15 | mA |
| I_{FL} | Logic Low Input Current | | 250 | μA |
| N | Fan Out (at $R_L = 1\text{k}\Omega$) | | 5 | TTL Loads |
| R_L | Output Pull-up Resistor | 330 | 4k | Ω |

Isolation Characteristics ($T_A=25^\circ\text{C}$)

| Symbol | Parameter | Test Conditions | Min. | Typ. | Max. | Units |
|-----------|--------------------------------|--|------|-----------|------|----------------|
| V_{ISO} | Input-Output Isolation Voltage | freq= 60Hz, t = 1.0min, $I_{I-O} \leq 10\mu\text{A}^{(5)(6)}$ | 3750 | | | $V_{AC_{RMS}}$ |
| R_{ISO} | Isolation Resistance | $V_{I-O} = 500\text{V}^{(5)}$ | | 10^{12} | | Ω |
| C_{ISO} | Isolation Capacitance | $V_{I-O} = 0\text{V}$, freq=1.0MHz ⁽⁵⁾ | | 0.6 | | pF |

Notes:

- No derate required to 110 $^\circ\text{C}$.
- Functional operation under these conditions is not implied. Permanent damage may occur if the device is subjected to conditions outside these ratings.
- 0.1 μF bypass capacitor must be connected between pins 4 and 6.
- Recommended I_{FH} is 9.3mA for operation above $T_A = 100^\circ\text{C}$.
- Device is considered a two terminal device: Pins 1 and 3 are shorted, and Pins 4, 5, and 6 are shorted together.
- 3,750 $V_{AC_{RMS}}$ for 1 minute duration is equivalent to 4,500 $V_{AC_{RMS}}$ for 1 second duration.

Electrical Characteristics (Apply over all recommended conditions)

($T_A = -40^\circ\text{C}$ to $+110^\circ\text{C}$, $3.0\text{V} \leq V_{CC} \leq 5.5\text{V}$), unless otherwise specified.

Typical value is measured at $T_A = 25^\circ\text{C}$ and $V_{CC} = 3.3\text{V}$.

| Symbol | Parameter | Test Conditions | Min. | Typ. | Max. | Units |
|-------------------------------|----------------------------------|---|------|------|------|---------------|
| INPUT CHARACTERISTICS | | | | | | |
| V_F | Forward Voltage | $I_F = 10\text{mA}$, Fig. 1 | 1.05 | 1.45 | 1.8 | V |
| BV_R | Input Reverse Breakdown Voltage | $I_R = 10\mu\text{A}$ | 5.0 | | | V |
| I_{FHL} | Threshold Input Current | $V_O = 0.6\text{V}$, $I_{OL}(\text{sinking}) = 13\text{mA}$, $T_A < 85^\circ\text{C}$, Fig. 2 | | 3.4 | 5.0 | mA |
| | | $T_A = 85^\circ\text{C}$ to 110°C | | 4.2 | 7.5 | |
| OUTPUT CHARACTERISTICS | | | | | | |
| V_{OL} | Logic LOW Output Voltage | $I_F = \text{rated } I_{FHL}$, $I_{OL}(\text{sinking}) = 13\text{mA}$, Fig.3 | | 0.4 | 0.6 | V |
| I_{OH} | Logic HIGH Output Current | $I_F = 250\mu\text{A}$, $V_O = 3.3\text{V}$, Fig. 4 | | 8.0 | 50.0 | μA |
| | | $I_F = 250\mu\text{A}$, $V_O = 5.0\text{V}$, Fig. 4 | | 2.1 | 30.0 | μA |
| I_{CCL} | Logic LOW Output Supply Current | $I_F = 10\text{mA}$, $V_{CC} = 3.3\text{V}$, Fig. 5, 7 | | 6.0 | 8.5 | mA |
| | | $I_F = 10\text{mA}$, $V_{CC} = 5.0\text{V}$, Fig. 5, 7 | | 7.5 | 10.0 | mA |
| I_{CCH} | Logic HIGH Output Supply Current | $I_F = 0\text{mA}$, $V_{CC} = 3.3\text{V}$, Fig. 6, 7 | | 4.0 | 7.0 | mA |
| | | $I_F = 0\text{mA}$, $V_{CC} = 5.0\text{V}$, Fig. 6, 7 | | 6.0 | 9.0 | mA |

Switching Characteristics (Apply over all recommended conditions)

($T_A = -40^\circ\text{C}$ to $+110^\circ\text{C}$, $3.0\text{V} \leq V_{CC} \leq 5.5\text{V}$, $I_F = 7.5\text{mA}$), unless otherwise specified.

Typical value is measured at $T_A = 25^\circ\text{C}$ and $V_{CC} = 3.3\text{V}$

| Symbol | Parameter | Test Conditions | Min. | Typ. | Max. | Units |
|-----------|--|---|------|------|------|-------------------|
| Date Rate | | $R_L = 350\Omega$ | | | 10 | Mbps |
| t_{PHL} | Propagation Delay Time to Logic Low Output | $R_L = 350\Omega$, $C_L = 15\text{pF}$, Fig. 8 and 11 | | 43 | 80 | ns |
| t_{PLH} | Propagation Delay Time to Logic High Output | $R_L = 350\Omega$, $C_L = 15\text{pF}$, Fig. 8 and 11 | | 50 | 80 | ns |
| PWD | Pulse Width Distortion, $ t_{PHL} - t_{PLH} $ | $R_L = 350\Omega$, $C_L = 15\text{pF}$, Fig. 9 | | 7 | 25 | ns |
| t_{PSK} | Propagation Delay Skew | $R_L = 350\Omega$, $C_L = 15\text{pF}^{(7)}$ | | | 40 | ns |
| t_R | Output Rise Time, (10% to 90%) | $R_L = 350\Omega$, $C_L = 15\text{pF}$, Fig. 10 and 11 | | 20 | | ns |
| t_F | Output Fall Time, (90% to 10%) | $R_L = 350\Omega$, $C_L = 15\text{pF}$, Fig. 10 and 11 | | 10 | | ns |
| $ CM_H $ | Common Mode Transient Immunity at Output High | $I_F = 0\text{mA}$, $V_O > 0.8 \times V_{CC}$, $V_{CM} = 1000\text{V}^{(8)}$, Fig. 12 | 20 | 40 | | kV/ μs |
| $ CM_L $ | Common Mode Transient Immunity at Output Low | $I_F = 7.5\text{mA}$, $V_O < 0.8\text{V}$, $V_{CM} = 1000\text{V}^{(8)}$, Fig. 12 | 20 | 40 | | kV/ μs |

Notes

- t_{PSK} is equal to the magnitude of the worst case difference in t_{PHL} and/or t_{PLH} that will be seen between any two units from the same manufacturing date code that are operated at same case temperature ($\pm 5^\circ\text{C}$), at same operating conditions, with equal loads ($R_L = 350\Omega$ and $C_L = 15\text{pF}$), and with an input rise time less than 5ns.
- Common mode transient immunity at output high is the maximum tolerable positive dV_{cm}/dt on the leading edge of the common mode impulse signal, V_{cm} , to assure that the output will remain high. Common mode transient immunity at output low is the maximum tolerable negative dV_{cm}/dt on the trailing edge of the common pulse signal, V_{cm} , to assure that the output will remain low.

Typical Performance Curves

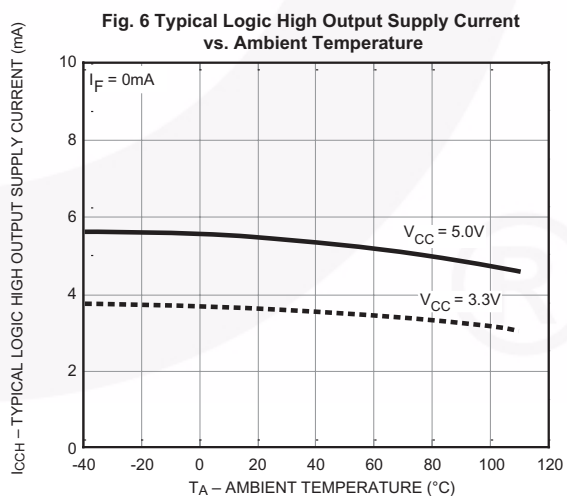
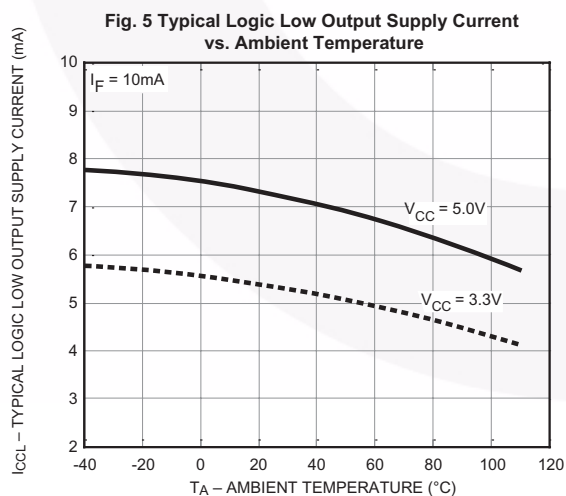
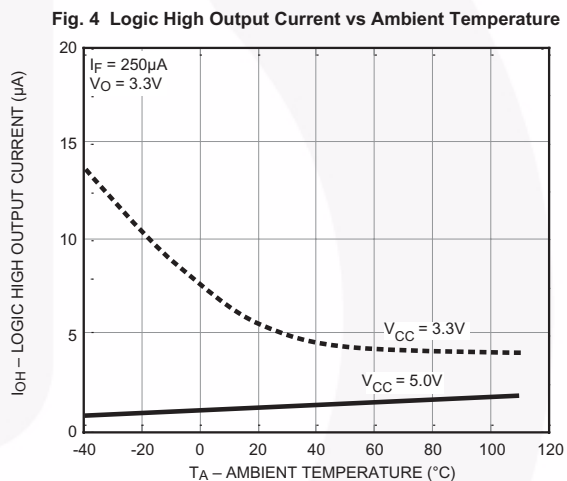
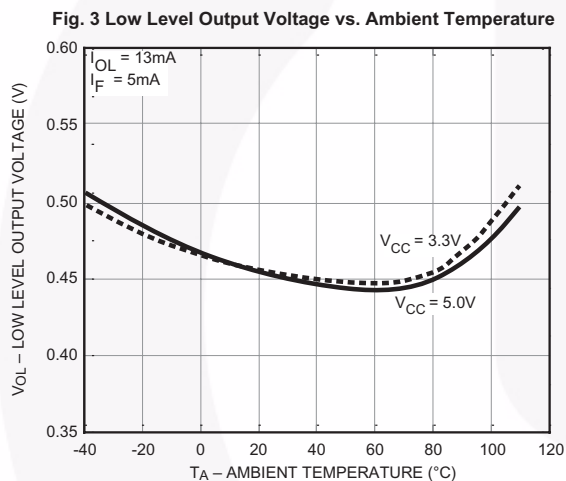
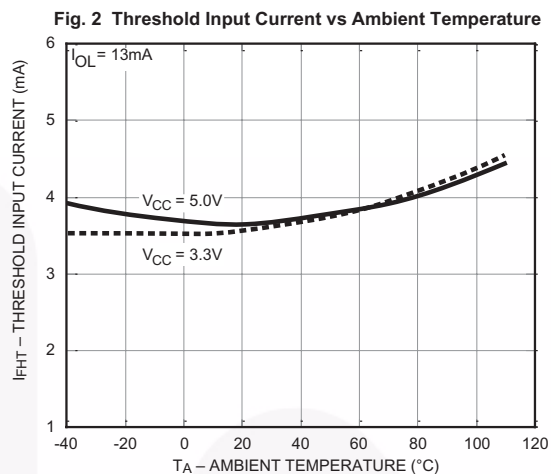
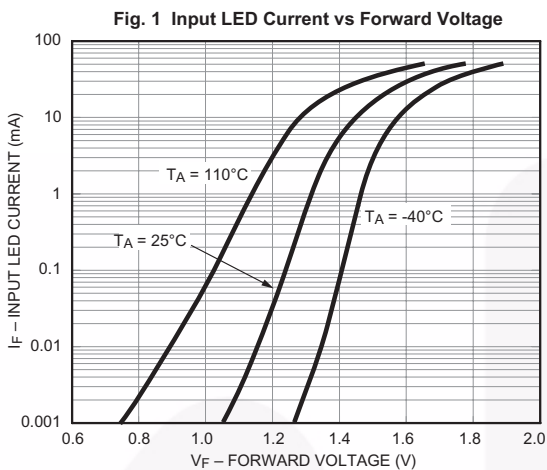

Typical Performance Curves (Continued)

Fig. 7 Typical Logic Output Supply Current vs. Output Supply Voltage

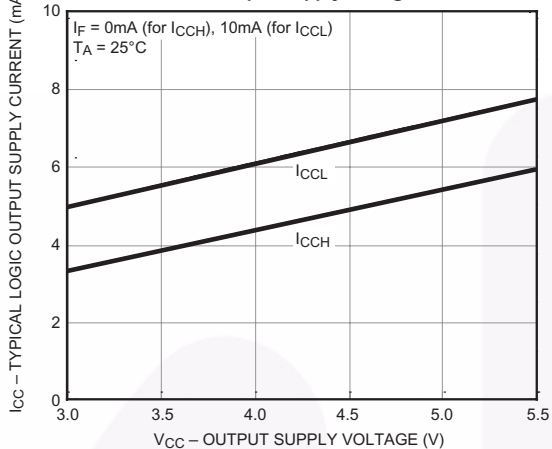

Fig. 8 Typical Propagation Delay vs. Ambient Temperature

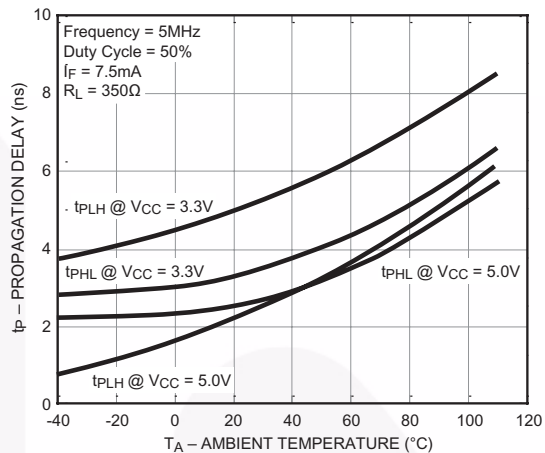

Fig. 9 Typical Pulse Width Distortion vs. Ambient Temperature

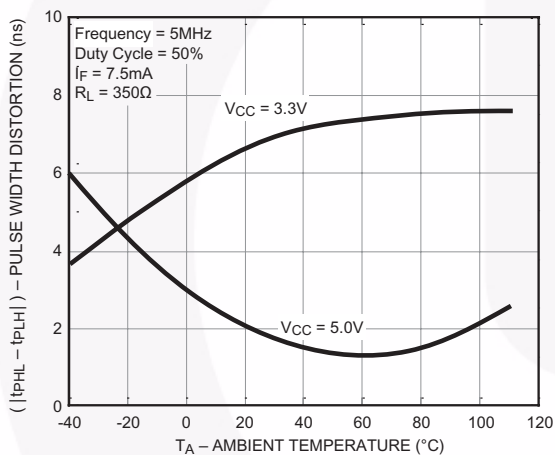
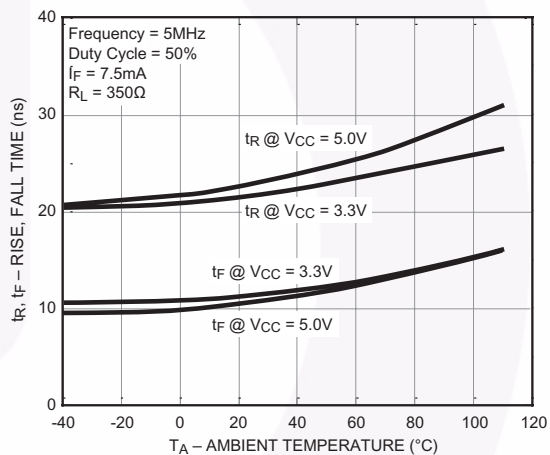

Fig. 10 Typical Rise and Fall Time vs. Ambient Temperature



Schematics

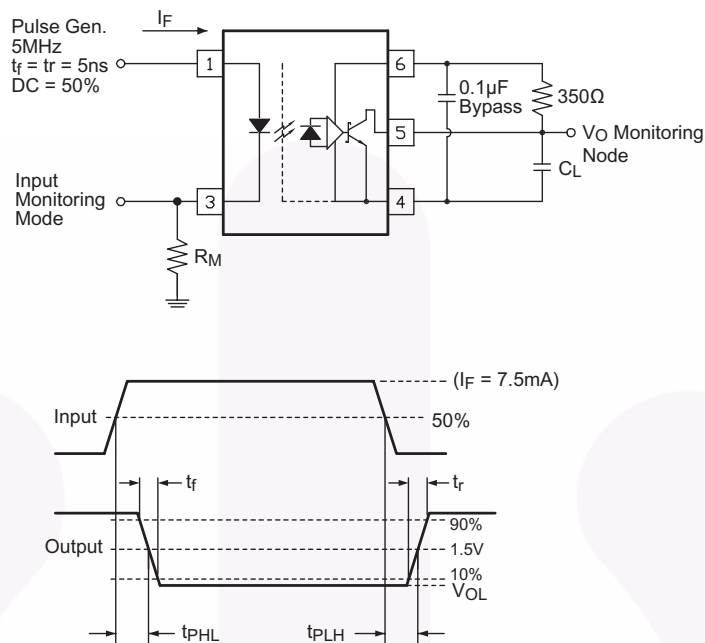

Figure 11. Test Circuit for Propagation Delay Time, Rise Time and Fall Time

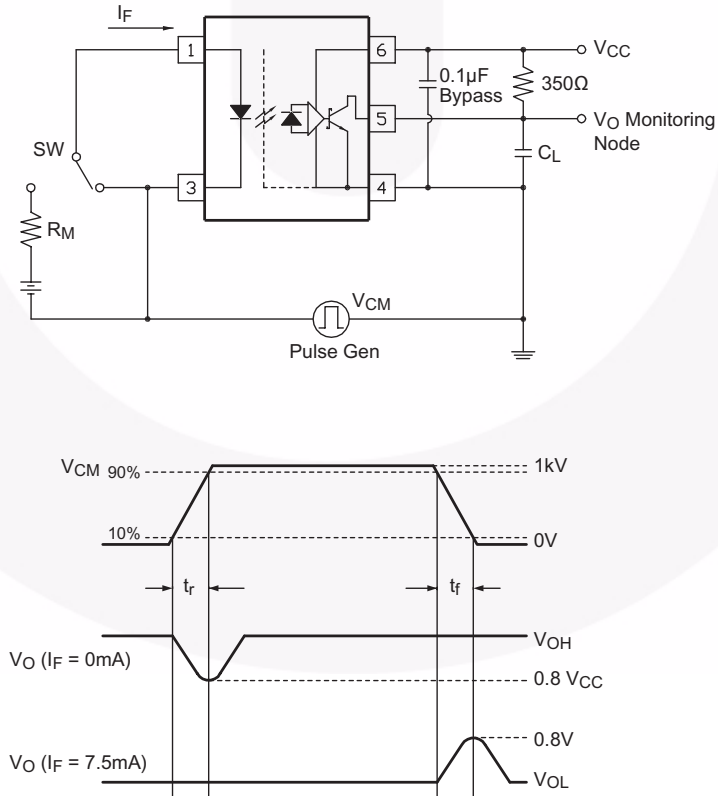
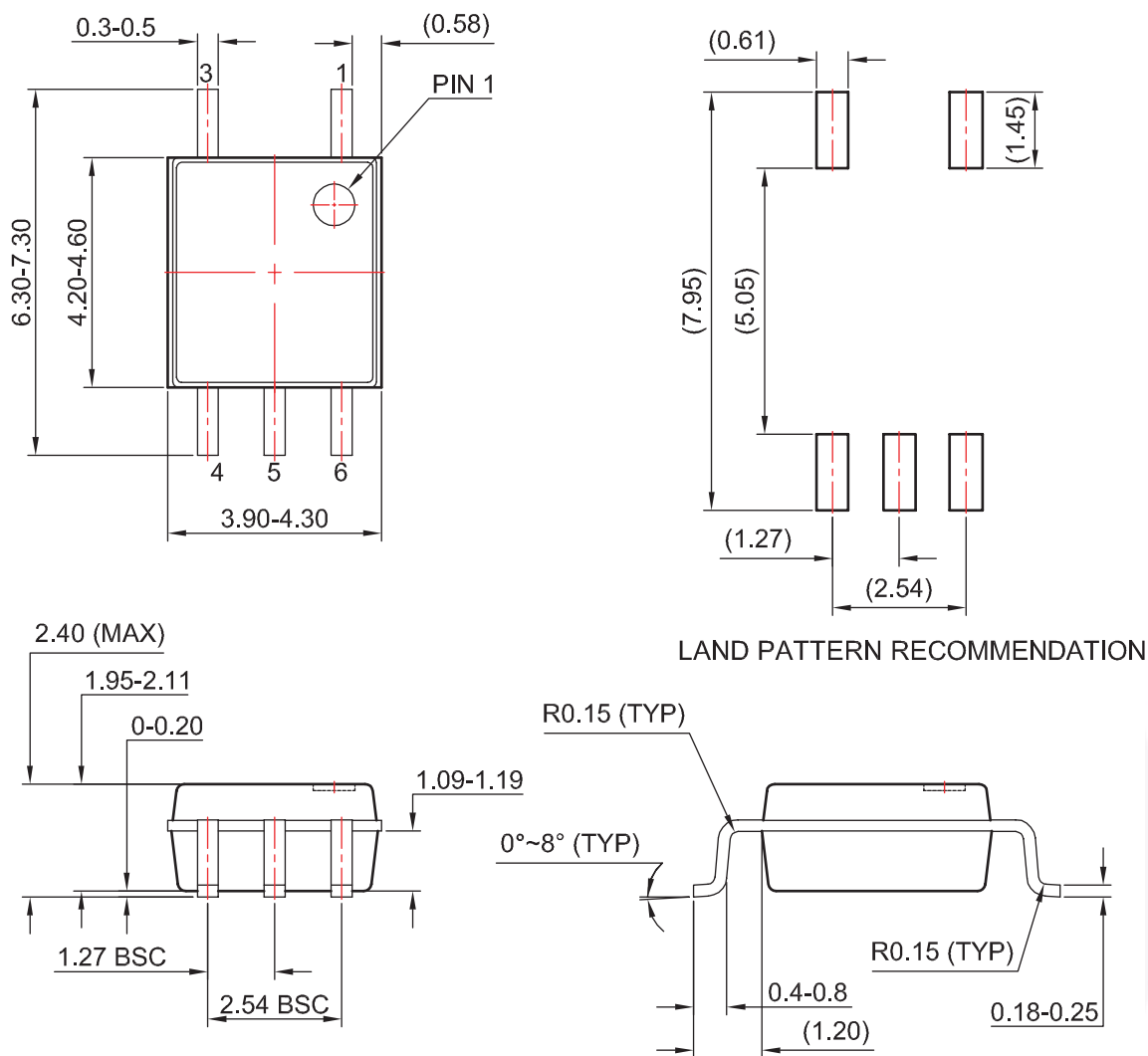

Figure 12. Test Circuit for Instantaneous Common Mode Rejection Voltage

Package Dimensions



Notes:

1. No standard applies to this package.
2. All dimensions are in millimeters.
3. Dimensions are exclusive of burrs, mold flash, and tie bar extrusion.
4. Drawings filename and revision: MKT-MFP05A.

Package drawings are provided as a service to customers considering Fairchild components. Drawings may change in any manner without notice. Please note the revision and/or date on the drawing and contact a Fairchild Semiconductor representative to verify or obtain the most recent revision. Package specifications do not expand the terms of Fairchild's worldwide terms and conditions, specifically the warranty therein, which covers Fairchild products.

Always visit Fairchild Semiconductor's online packaging area for the most recent package drawings:

<http://www.fairchildsemi.com/packaging/>

Ordering Information

| Option | Order Entry Identifier (Example) | Description |
|-----------|----------------------------------|--|
| No Suffix | FODM8061 | Mini-Flat 5-pin, shipped in tubes (100 units per tube) |
| R2 | FODM8061R2 | Mini-Flat 5-pin, tape and reel (2,500 units per reel) |

 All packages are lead free per JEDEC: J-STD-020B standard.

Marking Information

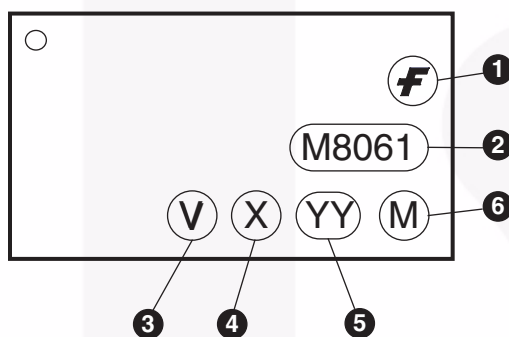

| Definitions | |
|-------------|---|
| 1 | Fairchild logo |
| 2 | Device number |
| 3 | IEC60747-5-2 (VDE marking) |
| 4 | One digit year code, e.g., '9' |
| 5 | Two digit work week ranging from '01' to '53' |
| 6 | Assembly package code |

Tape and Reel Dimensions

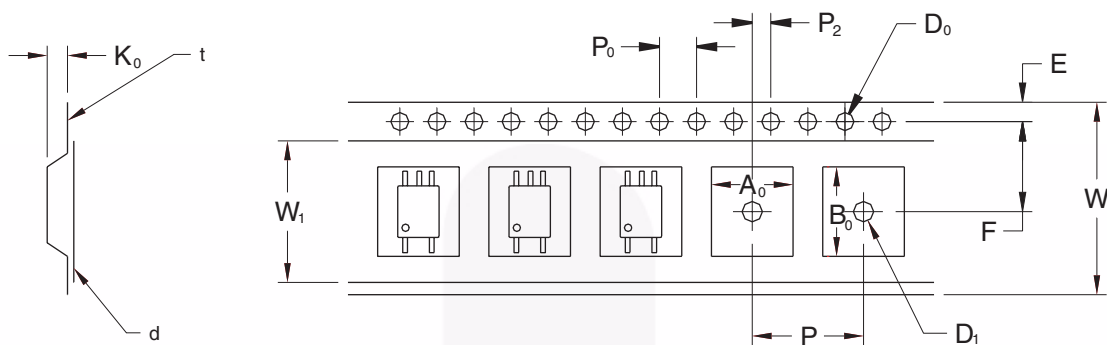

| | | 2.54 Pitch |
|---------------------------------|----------------|-------------------|
| Description | Symbol | Dimensions (mm) |
| Tape Width | W | 12.00 +0.30/-0.10 |
| Tape Thickness | t | 0.30 ±0.05 |
| Sprocket Hole Pitch | P ₀ | 4.00 ±0.10 |
| Sprocket Hole Diameter | D ₀ | 1.50 +0.10/-0.0 |
| Sprocket Hole Location | E | 1.75 ±0.10 |
| Pocket Location | F | 5.50 ±0.10 |
| | P ₂ | 2.00 ±0.10 |
| Pocket Pitch | P | 8.00 ±0.10 |
| Pocket Dimension | A ₀ | 4.40 ±0.10 |
| | B ₀ | 7.30 ±0.10 |
| | K ₀ | 2.30 ±0.10 |
| Pocket Hole Diameter | D ₁ | 1.50 Min. |
| Cover Tape Width | W ₁ | 9.20 |
| Cover Tape Thickness | d | 0.065 ±0.010 |
| Max. Component Rotation or Tilt | | 10° Max. |
| Devices Per Reel | | 2500 |
| Reel Diameter | | 330mm (13") |

Reflow Profile

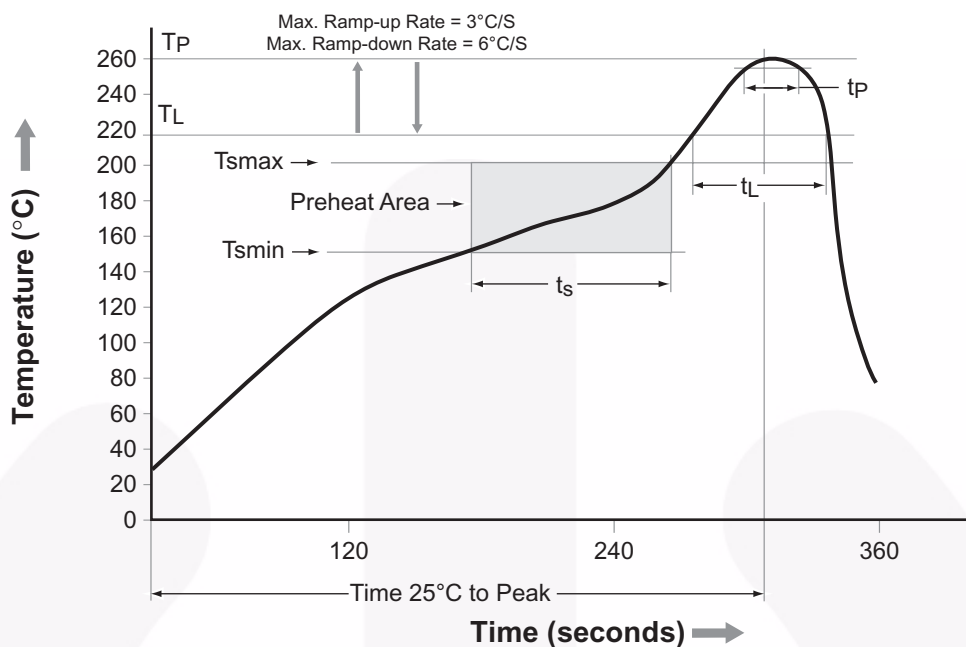

| Profile Feature | Pb-Free Assembly Profile |
|---|--------------------------|
| Temperature Min. (T _{smin}) | 150°C |
| Temperature Max. (T _{smax}) | 200°C |
| Time (t _s) from (T _{smin} to T _{smax}) | 60–120 seconds |
| Ramp-up Rate (t _L to t _p) | 3°C/second max. |
| Liquidous Temperature (T _L) | 217°C |
| Time (t _L) Maintained Above (T _L) | 60–150 seconds |
| Peak Body Package Temperature | 260°C +0°C / -5°C |
| Time (t _p) within 5°C of 260°C | 30 seconds |
| Ramp-down Rate (T _P to T _L) | 6°C/second max. |
| Time 25°C to Peak Temperature | 8 minutes max. |



TRADEMARKS

The following includes registered and unregistered trademarks and service marks, owned by Fairchild Semiconductor and/or its global subsidiaries, and is not intended to be an exhaustive list of all such trademarks.

- | | | | |
|--------------------------|-------------------------------------|---------------------------------------|---|
| AccuPower™ | F-PFS™ | Power-SPM™ | <p>SYSTEM GENERAL The Power Franchise® the power™ franchise TinyBoost™ TinyBuck™ TinyCalc™ TinyLogic™ TINYOPTO™ TinyPower™ SignalWise™ SmartMax™ SMART START™ SPM® STEALTH™ SuperFET™ SuperSOT™-3 SuperSOT™-6 SuperSOT™-8 SupreMOS® SyncFET™ Sync-Lock™</p> |
| Auto-SPM™ | FRFET® | PowerTrench® | |
| Build it Now™ | Global Power Resource SM | PowerXS™ | |
| CorePLUS™ | Green FPS™ | Programmable Active Droop™ | |
| CorePOWER™ | Green FPS™ e-Series™ | QFET® | |
| CROSSVOLT™ | Gmax™ | QS™ | |
| CTL™ | GTO™ | Quiet Series™ | |
| Current Transfer Logic™ | IntelliMAX™ | RapidConfigure™ | |
| DEUXPEED® | ISOPLANAR™ | ™ | |
| Dual Cool™ | MegaBuck™ | Saving our world, 1mW/W/kW at a time™ | |
| EcoSPARK® | MICROCOUPLER™ | SignalWise™ | |
| EfficientMax™ | MicroFET™ | SmartMax™ | |
| ESBC™ | MicroPak™ | SMART START™ | |
| Fairchild® | MicroPak2™ | SPM® | |
| Fairchild Semiconductor® | MillerDrive™ | STEALTH™ | |
| FACT Quiet Series™ | MotionMax™ | SuperFET™ | |
| FACT® | Motion-SPM™ | SuperSOT™-3 | |
| FAST® | OptoHIT™ | SuperSOT™-6 | |
| FastvCore™ | OPTOLOGIC® | SuperSOT™-8 | |
| FETBench™ | OPTOPLANAR® | SupreMOS® | |
| FlashWriter®* | SyncFET™ | SyncFET™ | |
| FPS™ | PDP SPM™ | Sync-Lock™ | |

* Trademarks of System General Corporation, used under license by Fairchild Semiconductor.

DISCLAIMER

FAIRCHILD SEMICONDUCTOR RESERVES THE RIGHT TO MAKE CHANGES WITHOUT FURTHER NOTICE TO ANY PRODUCTS HEREIN TO IMPROVE RELIABILITY, FUNCTION, OR DESIGN. FAIRCHILD DOES NOT ASSUME ANY LIABILITY ARISING OUT OF THE APPLICATION OR USE OF ANY PRODUCT OR CIRCUIT DESCRIBED HEREIN; NEITHER DOES IT CONVEY ANY LICENSE UNDER ITS PATENT RIGHTS, NOR THE RIGHTS OF OTHERS. THESE SPECIFICATIONS DO NOT EXPAND THE TERMS OF FAIRCHILD'S WORLDWIDE TERMS AND CONDITIONS, SPECIFICALLY THE WARRANTY THEREIN, WHICH COVERS THESE PRODUCTS.

LIFE SUPPORT POLICY

FAIRCHILD'S PRODUCTS ARE NOT AUTHORIZED FOR USE AS CRITICAL COMPONENTS IN LIFE SUPPORT DEVICES OR SYSTEMS WITHOUT THE EXPRESS WRITTEN APPROVAL OF FAIRCHILD SEMICONDUCTOR CORPORATION.

As used herein:

- Life support devices or systems are devices or systems which, (a) are intended for surgical implant into the body or (b) support or sustain life, and (c) whose failure to perform when properly used in accordance with instructions for use provided in the labeling, can be reasonably expected to result in a significant injury of the user.
- A critical component in any component of a life support, device, or system whose failure to perform can be reasonably expected to cause the failure of the life support device or system, or to affect its safety or effectiveness.

ANTI-COUNTERFEITING POLICY

Fairchild Semiconductor Corporation's Anti-Counterfeiting Policy. Fairchild's Anti-Counterfeiting Policy is also stated on our external website, www.fairchildsemi.com, under Sales Support.

Counterfeiting of semiconductor parts is a growing problem in the industry. All manufacturers of semiconductor products are experiencing counterfeiting of their parts. Customers who inadvertently purchase counterfeit parts experience many problems such as loss of brand reputation, substandard performance, failed applications, and increased cost of production and manufacturing delays. Fairchild is taking strong measures to protect ourselves and our customers from the proliferation of counterfeit parts. Fairchild strongly encourages customers to purchase Fairchild parts either directly from Fairchild or from Authorized Fairchild Distributors who are listed by country on our web page cited above. Products customers buy either from Fairchild directly or from Authorized Fairchild Distributors are genuine parts, have full traceability, meet Fairchild's quality standards for handling and storage and provide access to Fairchild's full range of up-to-date technical and product information. Fairchild and our Authorized Distributors will stand behind all warranties and will appropriately address any warranty issues that may arise. Fairchild will not provide any warranty coverage or other assistance for parts bought from Unauthorized Sources. Fairchild is committed to combat this global problem and encourage our customers to do their part in stopping this practice by buying direct or from authorized distributors.

PRODUCT STATUS DEFINITIONS

Definition of Terms

| Datasheet Identification | Product Status | Definition |
|--------------------------|-----------------------|---|
| Advance Information | Formative / In Design | Datasheet contains the design specifications for product development. Specifications may change in any manner without notice. |
| Preliminary | First Production | Datasheet contains preliminary data; supplementary data will be published at a later date. Fairchild Semiconductor reserves the right to make changes at any time without notice to improve design. |
| No Identification Needed | Full Production | Datasheet contains final specifications. Fairchild Semiconductor reserves the right to make changes at any time without notice to improve the design. |
| Obsolete | Not In Production | Datasheet contains specifications on a product that is discontinued by Fairchild Semiconductor. The datasheet is for reference information only. |

Rev. 149