

DVI-ST-24-2

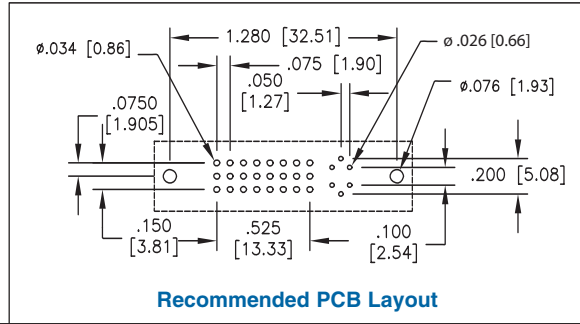

Recommended PCB Layout

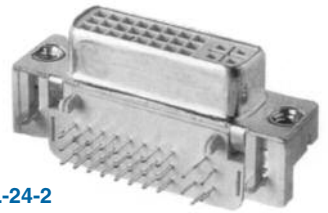
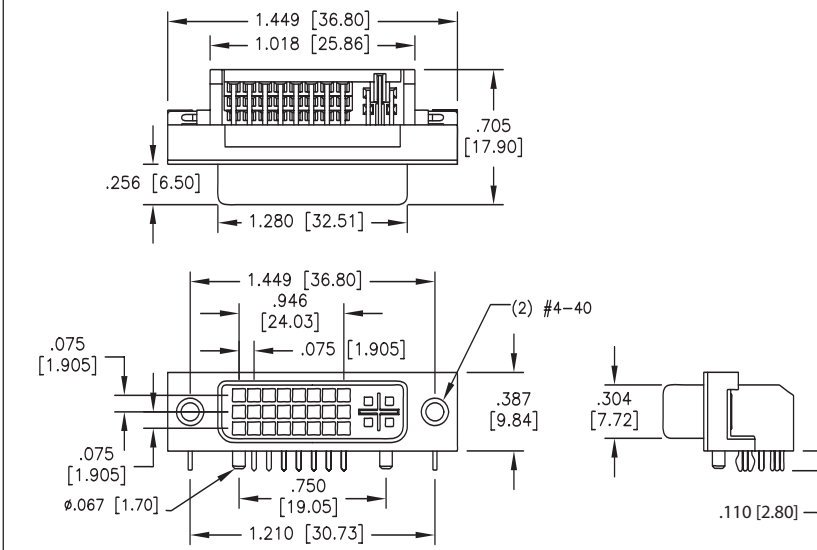

DVI-SL-24-2

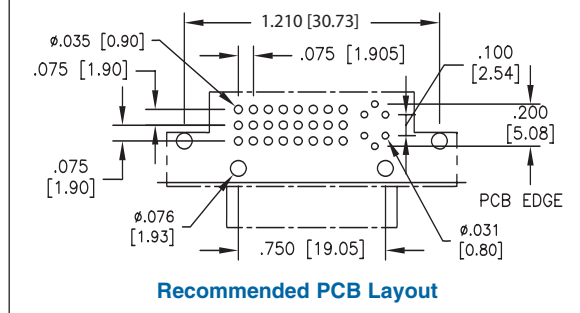

Recommended PCB Layout

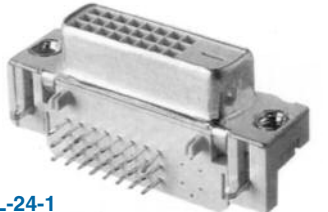
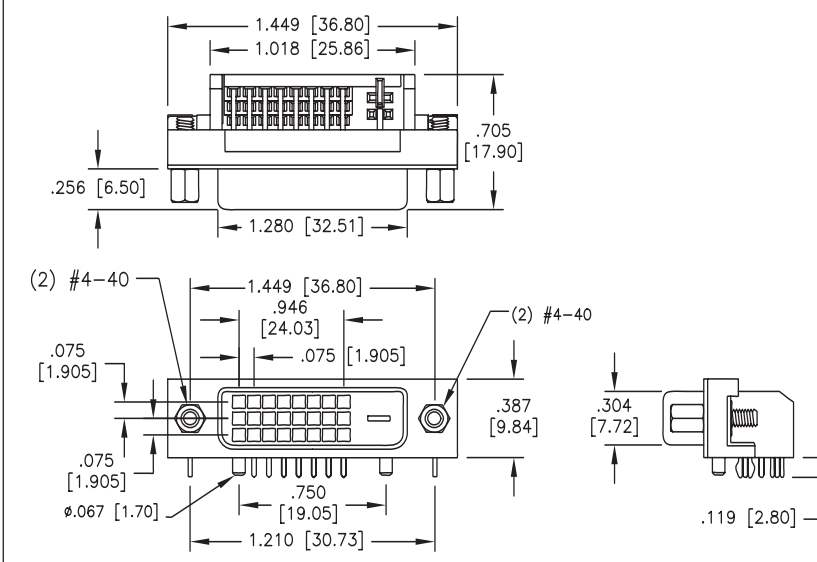

DVI-SL-24-1

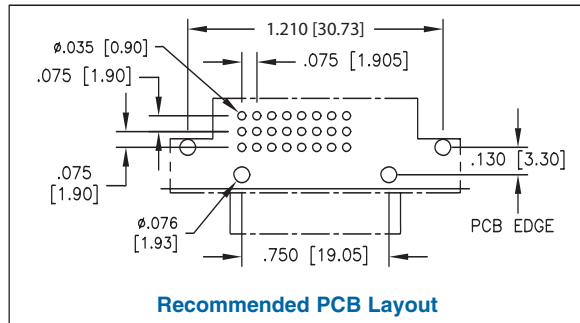

Recommended PCB Layout