

**Features**

- Epitaxial Planar Die Construction
- Complementary NPN Type Available (MMST2222A)
- Ultra-Small Surface Mount Package
- **Lead Free/RoHS Compliant (Note 2)**
- **"Green" Device (Note 3 and 4)**

**Mechanical Data**

- Case: SOT-323
- Case Material: Molded Plastic, "Green" Molding Compound. UL Flammability Classification Rating 94V-0 (Note 4)
- Moisture Sensitivity: Level 1 per J-STD-020C
- Terminals: Solderable per MIL-STD-202, Method 208
- Terminal Connections: See Diagram
- Lead Free Plating (Matte Tin Finish annealed over Alloy 42 leadframe).
- Marking Information: K3F - See Page 4
- Ordering & Date Code Information: See Page 4
- Weight: 0.006 grams (approximate)

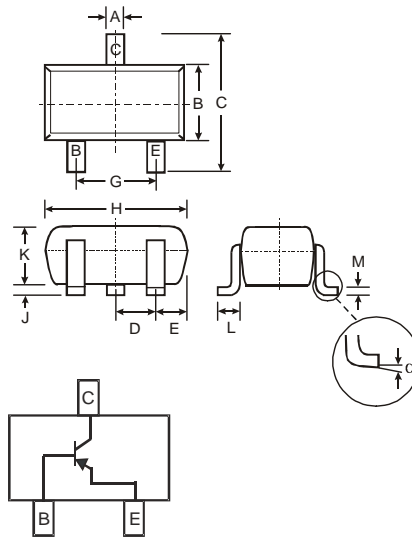

SOT-323		
Dim	Min	Max
A	0.25	0.40
B	1.15	1.35
C	2.00	2.20
D	0.65 Nominal	
E	0.30	0.40
G	1.20	1.40
H	1.80	2.20
J	0.0	0.10
K	0.90	1.00
L	0.25	0.40
M	0.10	0.18
$\alpha$	0°	8°
All Dimensions in mm		

**Maximum Ratings** @ $T_A = 25^\circ\text{C}$  unless otherwise specified

Characteristic	Symbol	Value	Unit
Collector-Base Voltage	$V_{CB0}$	-60	V
Collector-Emitter Voltage	$V_{CE0}$	-60	V
Emitter-Base Voltage	$V_{EB0}$	-5.0	V
Collector Current - Continuous (Note 1)	$I_C$	-600	mA
Power Dissipation (Note 1)	$P_d$	200	mW
Thermal Resistance, Junction to Ambient (Note 1)	$R_{\theta JA}$	625	$^\circ\text{C}/\text{W}$
Operating and Storage and Temperature Range	$T_j, T_{STG}$	-55 to +150	$^\circ\text{C}$

- Note:
1. Device mounted on FR-4 PCB, 1 inch x 0.85 inch x 0.062 inch; pad layout as shown on Diodes Inc. suggested pad layout document AP02001, which can be found on our website at <http://www.diodes.com/datasheets/ap02001.pdf>.
  2. No purposefully added lead.
  3. Diodes Inc.'s "Green" policy can be found on our website at [http://www.diodes.com/products/lead\\_free/index.php](http://www.diodes.com/products/lead_free/index.php).
  4. Product manufactured with Date Code 0627 (week 27, 2006) and newer are built with Green Molding Compound. Product manufactured prior to Date Code 0627 are built with Non-Green Molding Compound and may contain Halogens or Sb2O3 Fire Retardants.

## Electrical Characteristics @T<sub>A</sub> = 25°C unless otherwise specified

Characteristic	Symbol	Min	Max	Unit	Test Condition
<b>OFF CHARACTERISTICS (Note 5)</b>					
Collector-Base Breakdown Voltage	V <sub>(BR)CBO</sub>	-60	—	V	I <sub>C</sub> = -10μA, I <sub>E</sub> = 0
Collector-Emitter Breakdown Voltage	V <sub>(BR)CEO</sub>	-60	—	V	I <sub>C</sub> = -10mA, I <sub>B</sub> = 0
Emitter-Base Breakdown Voltage	V <sub>(BR)EBO</sub>	-5.0	—	V	I <sub>E</sub> = -10μA, I <sub>C</sub> = 0
Collector Cutoff Current	I <sub>CBO</sub>	—	-10	nA μA	V <sub>CB</sub> = -50V, I <sub>E</sub> = 0 V <sub>CB</sub> = -50V, I <sub>E</sub> = 0, T <sub>A</sub> = 125°C
Collector Cutoff Current	I <sub>CEX</sub>	—	-50	nA	V <sub>CE</sub> = -30V, V <sub>EB(OFF)</sub> = -0.5V
Base Cutoff Current	I <sub>BL</sub>	—	-50	nA	V <sub>CE</sub> = -30V, V <sub>EB(OFF)</sub> = -0.5V
<b>ON CHARACTERISTICS (Note 5)</b>					
DC Current Gain	h <sub>FE</sub>	75 100 100 100 50	— — — 300 —	—	I <sub>C</sub> = -100μA, V <sub>CE</sub> = -10V I <sub>C</sub> = -1.0mA, V <sub>CE</sub> = -10V I <sub>C</sub> = -10mA, V <sub>CE</sub> = -10V I <sub>C</sub> = -150mA, V <sub>CE</sub> = -10V I <sub>C</sub> = -500mA, V <sub>CE</sub> = -10V
Collector-Emitter Saturation Voltage	V <sub>CE(SAT)</sub>	—	-0.4 -1.6	V	I <sub>C</sub> = -150mA, I <sub>B</sub> = -15mA I <sub>C</sub> = -500mA, I <sub>B</sub> = -50mA
Base-Emitter Saturation Voltage	V <sub>BE(SAT)</sub>	—	-1.3 -2.6	V	I <sub>C</sub> = 150mA, I <sub>B</sub> = 15mA I <sub>C</sub> = 500mA, I <sub>B</sub> = 50mA
<b>SMALL SIGNAL CHARACTERISTICS</b>					
Output Capacitance	C <sub>obo</sub>	—	8.0	pF	V <sub>CB</sub> = -10V, f = 1.0MHz, I <sub>E</sub> = 0
Input Capacitance	C <sub>ibo</sub>	—	30	pF	V <sub>EB</sub> = -2.0V, f = 1.0MHz, I <sub>C</sub> = 0
Current Gain-Bandwidth Product	f <sub>T</sub>	200	—	MHz	V <sub>CE</sub> = -20V, I <sub>C</sub> = -50mA, f = 100MHz
<b>SWITCHING CHARACTERISTICS</b>					
Turn-On Time	t <sub>on</sub>	—	45	ns	V <sub>CC</sub> = -30V, I <sub>C</sub> = -150mA, I <sub>B1</sub> = -15mA
Delay Time	t <sub>d</sub>	—	10	ns	
Rise Time	t <sub>r</sub>	—	40	ns	
Turn-Off Time	t <sub>off</sub>	—	100	ns	V <sub>CC</sub> = -6.0V, I <sub>C</sub> = -150mA, I <sub>B1</sub> = I <sub>B2</sub> = -15mA
Storage Time	t <sub>s</sub>	—	80	ns	
Fall Time	t <sub>f</sub>	—	30	ns	

Notes: 5. Short duration pulse test used to minimize self-heating effect.

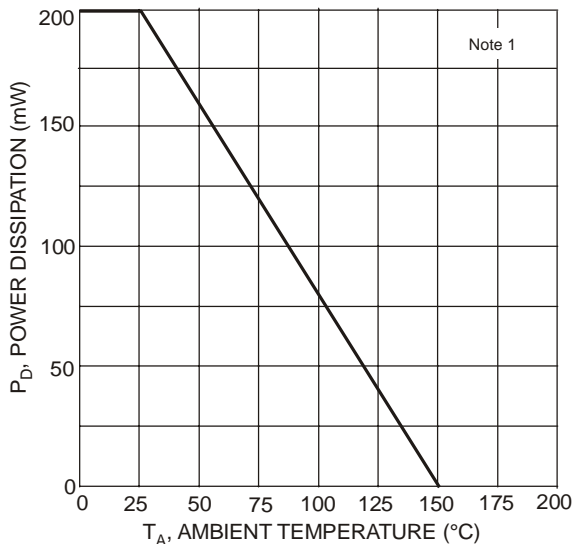

Fig. 1 Max Power Dissipation vs. Ambient Temperature

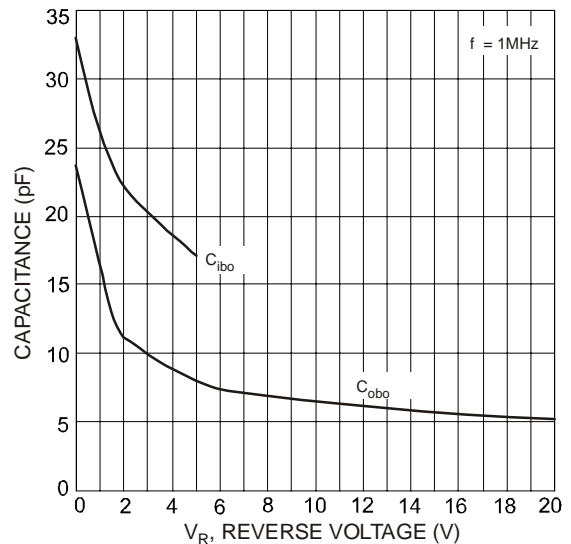

Fig. 2 Typical Capacitance Characteristics

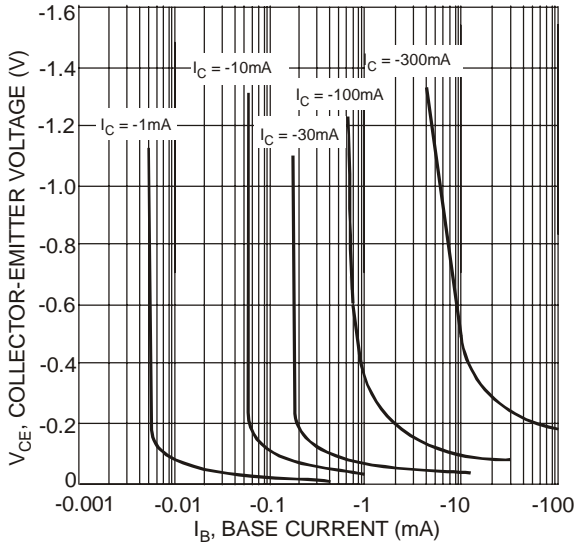

Fig. 3 Typical Collector Saturation Region

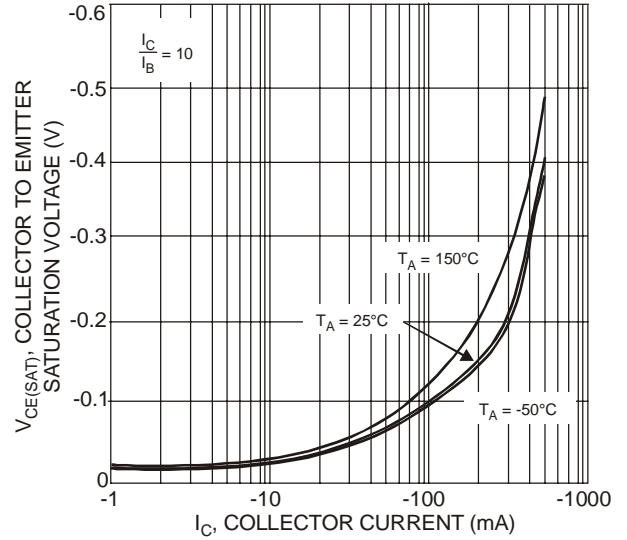

Fig. 4 Collector-Emitter Saturation Voltage vs. Collector Current

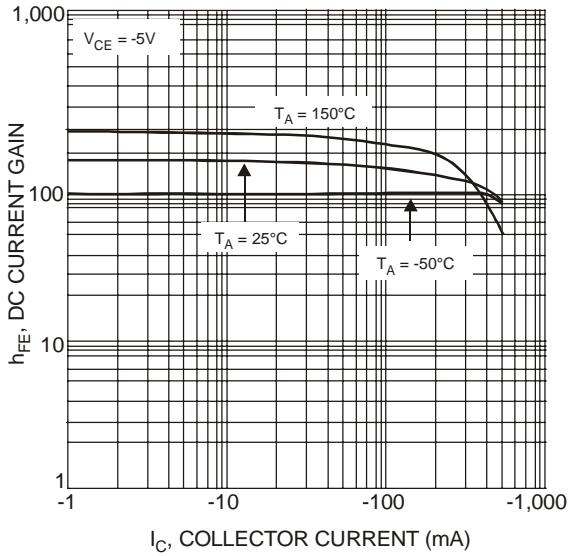

Fig. 5 DC Current Gain vs. Collector Current

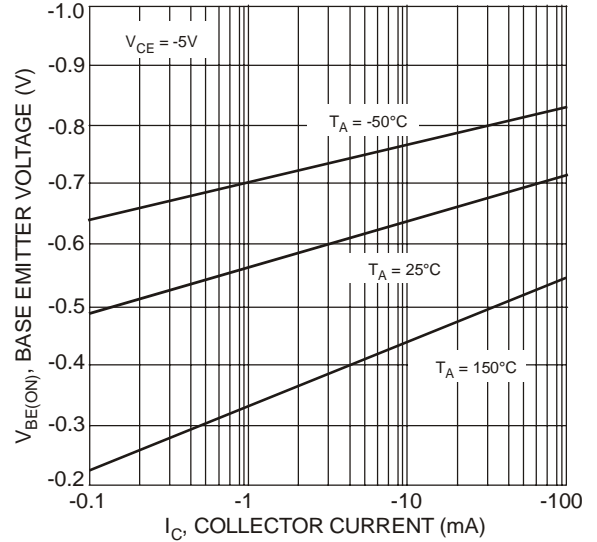

Fig. 6 Base-Emitter Voltage vs. Collector Current

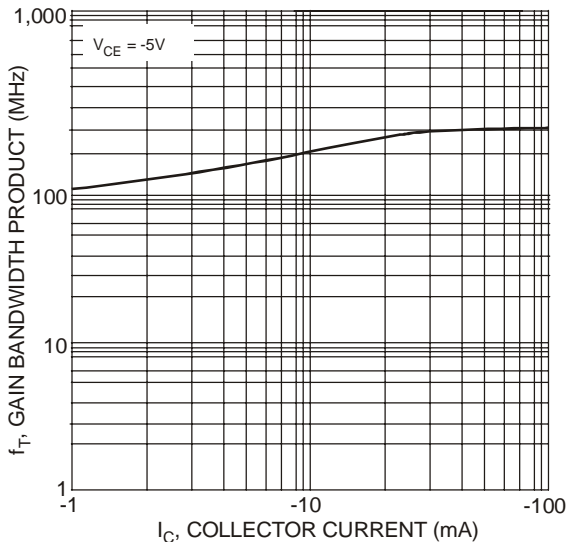

Fig. 7 Gain Bandwidth Product vs. Collector Current

## Ordering Information (Note 4 and 6)

Device	Packaging	Shipping
MMST2907A-7-F	SOT-323	3000/Tape & Reel

Notes: 6. For packaging details, go to our website at <http://www.diodes.com/datasheets/ap02007.pdf>.

## Marking Information

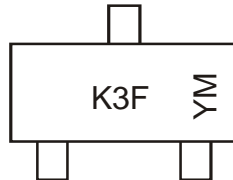

K3F = Product Type Marking Code  
 YM = Date Code Marking  
 Y = Year ex: N = 2002  
 M = Month ex: 9 = September

### Date Code Key

Year	1998	1999	2000	2001	2002	2003	2004	2005	2006	2007	2008	2009	2010	2011	2012
Code	J	K	L	M	N	P	R	S	T	U	V	W	X	Y	Z

Month	Jan	Feb	Mar	Apr	May	Jun	Jul	Aug	Sep	Oct	Nov	Dec
Code	1	2	3	4	5	6	7	8	9	O	N	D

### IMPORTANT NOTICE

Diodes Incorporated and its subsidiaries reserve the right to make modifications, enhancements, improvements, corrections or other changes without further notice to any product herein. Diodes Incorporated does not assume any liability arising out of the application or use of any product described herein; neither does it convey any license under its patent rights, nor the rights of others. The user of products in such applications shall assume all risks of such use and will agree to hold Diodes Incorporated and all the companies whose products are represented on our website, harmless against all damages.

### LIFE SUPPORT

Diodes Incorporated products are not authorized for use as critical components in life support devices or systems without the expressed written approval of the President of Diodes Incorporated.