

PLEASE CHECK WWW.MOLEX.COM FOR LATEST PART INFORMATION

Part Number: **0736562000**
Status: **Active**
Overview: hdm
Description: 2.00mm (.079") Pitch HDM® Board-to-Board Backplane Power Module, Vertical, SMC, Power Receptacle, 3 Circuits, Gold (Au) 0.76µm (30µ")

Documents:

[Drawing \(PDF\)](#) [RoHS Certificate of Compliance \(PDF\)](#)
[Product Specification PS-73670-9999 \(PDF\)](#)

General

Product Family	Backplane Connectors
Series	<u>73656</u>
Application	Backplane
Comments	Backplane Power Module
Component Type	Power Header
Overview	<u>hdm</u>
Product Name	HDM®
Style	N/A

Physical

Circuits (Loaded)	3
Circuits (maximum)	3
Color - Resin	Black
Durability (mating cycles max)	250
First Mate / Last Break	No
Guide to Mating Part	No
Keying to Mating Part	None
Material - Metal	Beryllium Copper
Material - Plating Mating	Gold
Material - Plating Termination	Gold
Material - Resin	High Temperature Thermoplastic
Number of Columns	1
Number of Pairs	Open Pin Field
Number of Rows	3
Orientation	Vertical
PC Tail Length (in)	0.138 In
PC Tail Length (mm)	3.50 mm
PCB Locator	No
PCB Retention	None
PCB Thickness Recommended (in)	0.138 In
PCB Thickness Recommended (mm)	3.50 mm
Packaging Type	Tube
Pitch - Mating Interface (in)	0.079 In
Pitch - Mating Interface (mm)	2.00 mm
Pitch - Term. Interface (in)	0.079 In
Pitch - Term. Interface (mm)	2.00 mm
Plating min: Mating (µin)	30
Plating min: Mating (µm)	0.75
Plating min: Termination (µin)	2
Plating min: Termination (µm)	0.05
Polarized to PCB	No
Stackable	No
Surface Mount Compatible (SMC)	Yes
Temperature Range - Operating	-55°C to +105°C
Termination Interface: Style	Through Hole - Compliant Pin

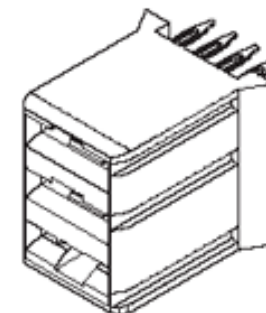

image - Reference only

Series

EU RoHS

**ELV and RoHS
Compliant**

REACH SVHC

Contains SVHC: No

Halogen-Free

Status

Not Reviewed

China RoHS



**Need more information on product
environmental compliance?**

Email productcompliance@molex.com
For a multiple part number RoHS Certificate of Compliance, [click here](#)

Please visit the [Contact Us](#) section for any non-product compliance questions.

Search Parts in this Series

[73656Series](#)

Mates With

[73651](#) HDM® Board-to-Board
Daughterboard Power Module

Electrical

Current - Maximum per Contact	15A
Data Rate	1.0 Gbps
Real Signals (per 25mm)	75
Shielded	No
Voltage - Maximum	500V AC

Material Info**Reference - Drawing Numbers**

Application Specification	AS-73656-1998
Packaging Specification	PK-70873-0819
Product Specification	PS-73670-9999
Sales Drawing	SDA-73656-*00*

HDM and High Density Metric are trademarks of Amphenol Corporation

This document was generated on 05/14/2010

PLEASE CHECK WWW.MOLEX.COM FOR LATEST PART INFORMATION

ASSEMBLY NUMBER	FINISH
73656-0000	SEE NOTE 2.
73656-0001	SEE NOTE 3.

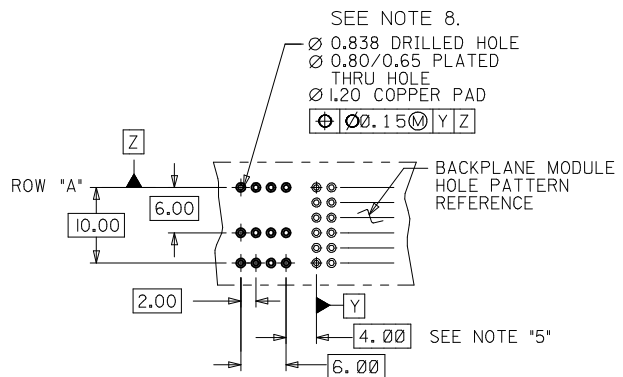
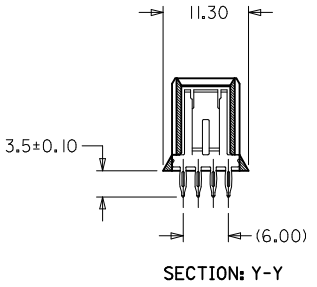
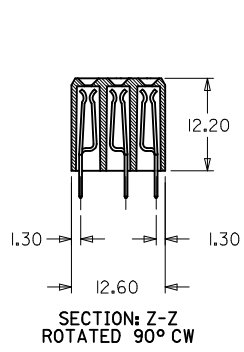
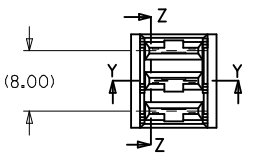
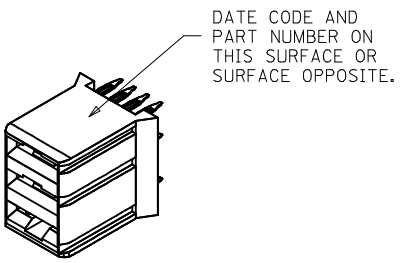

PCB LAYOUT: COMPONENT SIDE
RECOMMENDED PCB THICKNESS: 2.50 MIN

NOTES:

1. MATERIALS: HOUSING - LIQUID CRYSTAL POLYMER (LCP), GLASS-FILLED, UL94V-0, COLOR: BLACK
TERMINAL - COPPER ALLOY
2. FINISH: SELECTIVE GOLD (Au) IN CONTACT AREA, 0.76 micrometer MINIMUM THICKNESS: NICKEL (Ni) AND GOLD FLASH OVERALL
3. FINISH: SELECTIVE GOLD (Au) IN CONTACT AREA, 0.76 micrometer MINIMUM THICKNESS: TIN/LEAD (Sn/Pb) OVER NICKEL (Ni) IN COMPLIANT AREA: NICKEL (Ni) OVERALL ON REMAINING WITH SELECTIVE GOLD (Au) FLASH.
4. THIS DIMENSION MUST BE A MULTIPLE OF 4.00 mm.
5. DIMENSIONS ARE IN MILLIMETERS.
6. THIS PART CONFORMS TO MOLEX PRODUCT SPECIFICATION PS-73670-9999.
7. PACKAGE ASSEMBLIES PER PK-70873-0819.
8. HOLE SIZE SPECIFICATION IS FOR TIN/LEAD PLATED HOLES ONLY. FOR OTHER PLATING TYPES SEE MOLEX APPLICATION AS-73670-9996.
9. THIS PART CONFORMS TO MOLEX COSMETIC SPECIFICATION PS-45499-002 CLASS B.

ADD NOTES 8 & 9 EC NO: UCP2009-1813 DRWNS:DANNELLEY 2009/07/17 CHKD:BSMART 2009/07/24 APPR:SMILLER 2009/07/24	QUALITY SYMBOLS ▽=0 ▽=0	GENERAL TOLERANCES (UNLESS SPECIFIED) <table border="1"> <tr> <th></th> <th>mm</th> <th>INCH</th> </tr> <tr> <td>4 PLACES</td> <td>± .005</td> <td>± .0004</td> </tr> <tr> <td>3 PLACES</td> <td>± .008</td> <td>± .0003</td> </tr> <tr> <td>2 PLACES</td> <td>± .010</td> <td>± .0002</td> </tr> <tr> <td>1 PLACE</td> <td>± .015</td> <td>± .0001</td> </tr> </table>		mm	INCH	4 PLACES	± .005	± .0004	3 PLACES	± .008	± .0003	2 PLACES	± .010	± .0002	1 PLACE	± .015	± .0001	DIMENSION STYLE MM ONLY DRAWN BY DATE ELO 1998/05/21 CHECKED BY DATE SMR 1998/05/21 APPROVED BY DATE CAB 1998/05/21	SCALE 1:1 DESIGN UNITS METRIC THIRD ANGLE PROJECTION	TITLE SALES ASSY , HDM BACKPLANE POWER MODULE (PRESSFIT) MOLEX MOLEX INCORPORATED MATERIAL NO. SEE TABLE DOCUMENT NO. SDA-73656-*00*	SHEET NO. 1 OF 4
		mm	INCH																		
	4 PLACES	± .005	± .0004																		
	3 PLACES	± .008	± .0003																		
2 PLACES	± .010	± .0002																			
1 PLACE	± .015	± .0001																			
DRAFT WHERE APPLICABLE MUST REMAIN WITHIN DIMENSIONS	THIS DRAWING CONTAINS INFORMATION THAT IS PROPRIETARY TO MOLEX INCORPORATED AND SHOULD NOT BE USED WITHOUT WRITTEN PERMISSION																				

DATE CODE AND
PART NUMBER ON
THIS SURFACE OR
SURFACE OPPOSITE.

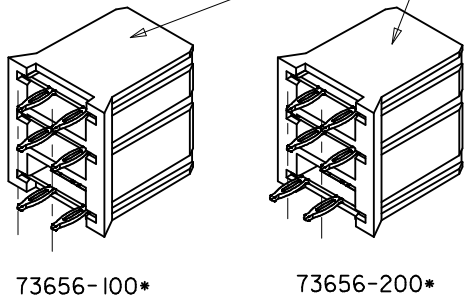

MIDPLANE OPTION

ASSEMBLY NUMBER	FINISH (SEE SHT 1)
73656-1000	SEE NOTE 2. (GOLD TAILS)
73656-2000	
73656-1001	SEE NOTE 3. (TIN/LEAD TAILS)
73656-2001	

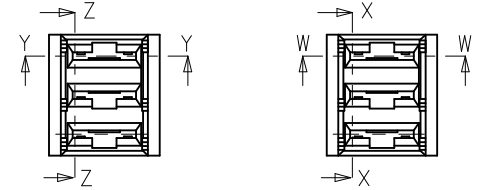

73656-200* 73656-100*

USE BACKPLANE MODULE
HOLE REFERENCE PATTERN
FROM SHEET 1

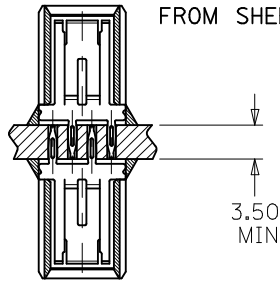

BACK-TO-BACK
MOUNTING APPLICATION

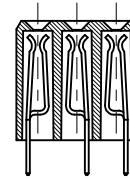

SECTION X-X
SECTION Z-Z
ROTATED 90° CW

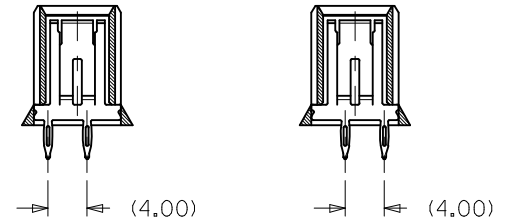

SECTION: Y-Y SECTION: W-W

SEE SHEET 1 EC NO: UCP2009-1813 DRWN: SDANNELLEY 2009/07/17 CHKD: BSMART 2009/07/24 APPR: SMILLER 2009/07/24	DESCRIPTION REV	QUALITY SYMBOLS	GENERAL TOLERANCES (UNLESS SPECIFIED)	DIMENSION STYLE	SCALE	DESIGN UNITS	THIRD ANGLE PROJECTION
		▼=0 ▽=0	mm INCH 4 PLACES ± --- ± --- 3 PLACES ± --- ± --- 2 PLACES ± --- ± --- 1 PLACE ± --- ± --- ANGULAR ±1/2°	MM ONLY	1:1	METRIC	TITLE SALES ASSY, HDM BACKPLANE POWER MODULE (PRESSFIT)
		DRAFT WHERE APPLICABLE MUST REMAIN WITHIN DIMENSIONS	DRAWN BY DATE ELO 1998/05/21 CHECKED BY DATE SMR 1998/05/21 APPROVED BY DATE CAB 1998/05/21	MATERIAL NO. SEE TABLE	DOCUMENT NO. SDA-73656-*00*	SHEET NO. 2 OF 4	
		THIS DRAWING CONTAINS INFORMATION THAT IS PROPRIETARY TO MOLEX INCORPORATED AND SHOULD NOT BE USED WITHOUT WRITTEN PERMISSION					

ASSEMBLY NUMBER	FINISH (SHT I)
73656-5000	SEE NOTE 2.
73656-5001	SEE NOTE 3.

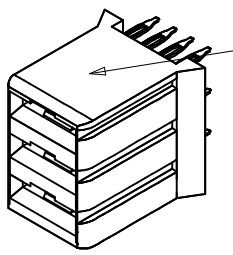

DATE CODE AND PART NUMBER ON THIS SURFACE OR SURFACE OPPOSITE.

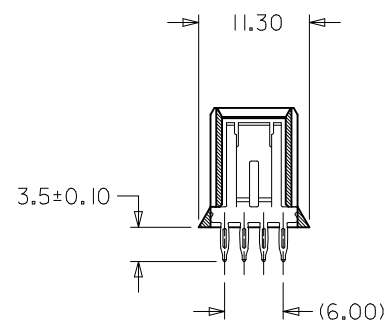
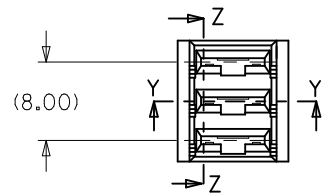

SECTION: Y-Y

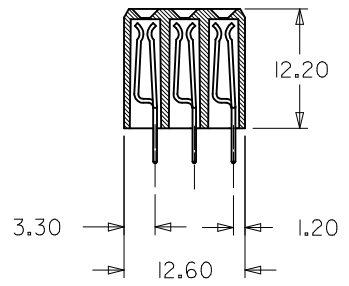

SECTION: Z-Z ROTATED 90° CW

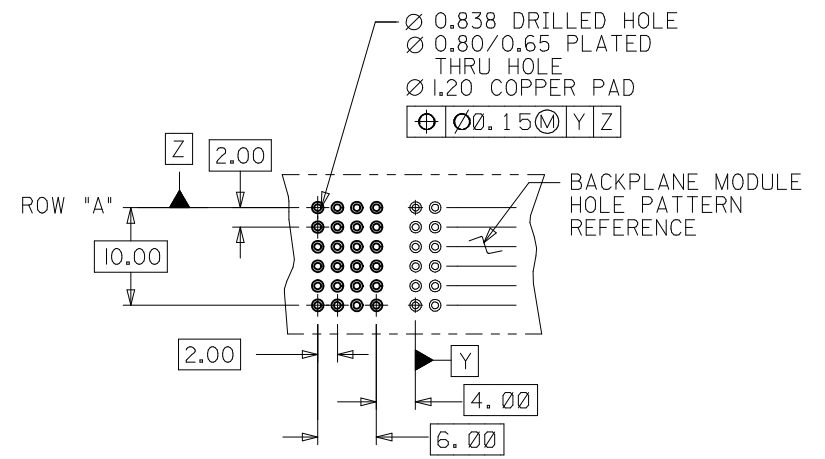
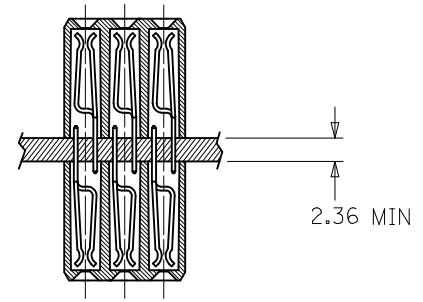

BACKPLANE MODULE HOLE PATTERN REFERENCE

SEE SHEET 1 EC NO: UCP2009-1813 DRWN:SDANNELLEY 2009/07/17 CHKD:BSMART 2009/07/24 APPR:SMILLER 2009/07/24	DESCRIPTION REV	QUALITY SYMBOLS ▽=0 ▽=0	GENERAL TOLERANCES (UNLESS SPECIFIED) mm INCH 4 PLACES ± --- ± --- 3 PLACES ± --- ± --- 2 PLACES ± --- ± --- 1 PLACE ± --- ± --- ANGULAR ±1/2°	DIMENSION STYLE MM ONLY DRAWN BY DATE ELO 1998/05/21 CHECKED BY DATE SMR 1998/05/21 APPROVED BY DATE CAB 1998/05/21	SCALE 1:1 DESIGN UNITS METRIC THIRD ANGLE PROJECTION	TITLE SALES ASSY , HDM BACKPLANE POWER MODULE (PRESSFIT)
		DRAFT WHERE APPLICABLE MUST REMAIN WITHIN DIMENSIONS	MATERIAL NO. SEE TABLE	DOCUMENT NO. SDA-73656-*00*	SHEET NO. 3 OF 4	
		THIS DRAWING CONTAINS INFORMATION THAT IS PROPRIETARY TO MOLEX INCORPORATED AND SHOULD NOT BE USED WITHOUT WRITTEN PERMISSION				
		MOLEX INCORPORATED				

ASSEMBLY NUMBER	FINISH
73656-0180	SEE NOTE 2.
73656-0181	SEE NOTE 3.

DATE CODE AND PART NUMBER ON THIS SURFACE OR SURFACE OPPOSITE.

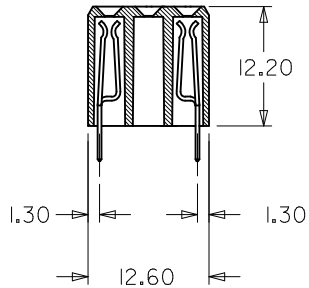
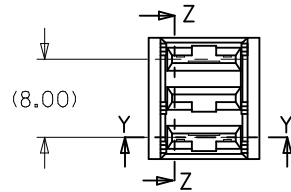
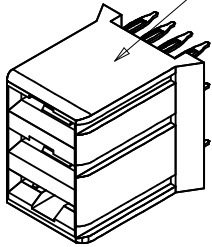

SECTION: Z-Z
ROTATED 90° CW

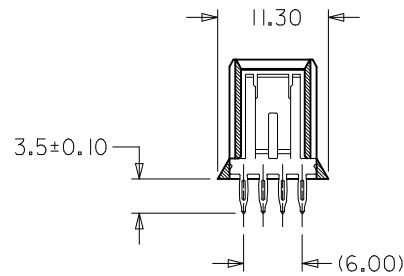

SECTION: Y-Y

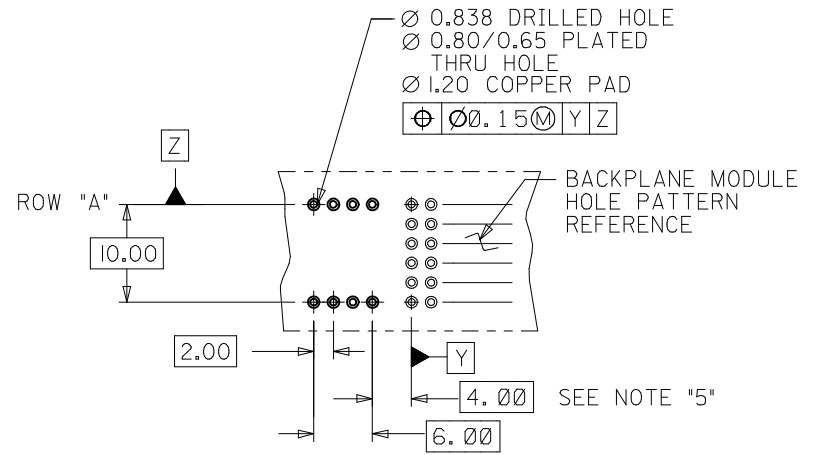

PCB LAYOUT: COMPONENT SIDE
RECOMMENDED PCB THICKNESS: 2.50 MIN

SEE SHEET 1 EC NO: UCP2009-1813 DRWN: SDANNELLEY 2009/07/17 CHKD: BSMART 2009/07/24 APPR: SMILLER 2009/07/24	DESCRIPTION REV	QUALITY SYMBOLS ▽=0 ▽=0	GENERAL TOLERANCES (UNLESS SPECIFIED) <table border="1"> <tr> <th></th> <th>mm</th> <th>INCH</th> </tr> <tr> <td>4 PLACES</td> <td>± ---</td> <td>± ---</td> </tr> <tr> <td>3 PLACES</td> <td>± ---</td> <td>± ---</td> </tr> <tr> <td>2 PLACES</td> <td>± ---</td> <td>± ---</td> </tr> <tr> <td>1 PLACE</td> <td>± ---</td> <td>± ---</td> </tr> </table>		mm	INCH	4 PLACES	± ---	± ---	3 PLACES	± ---	± ---	2 PLACES	± ---	± ---	1 PLACE	± ---	± ---	DIMENSION STYLE MM ONLY DRAWN BY DATE ELO 1998/05/21 CHECKED BY DATE SMR 1998/05/21 APPROVED BY DATE CAB 1998/05/21	SCALE 1:1 DESIGN UNITS METRIC THIRD ANGLE PROJECTION
			mm	INCH																
		4 PLACES	± ---	± ---																
		3 PLACES	± ---	± ---																
2 PLACES	± ---	± ---																		
1 PLACE	± ---	± ---																		
DRAFT WHERE APPLICABLE MUST REMAIN WITHIN DIMENSIONS			MATERIAL NO. SEE TABLE	TITLE SALES ASSY , HDM BACKPLANE POWER MODULE (PRESSFIT)																
			MOLEX INCORPORATED	DOCUMENT NO. SDA-73656-*00*																
			SIZE B	SHEET NO. 4 OF 4																

DATE CODE AND PART NUMBER ON THIS SURFACE OR SURFACE OPPOSITE.

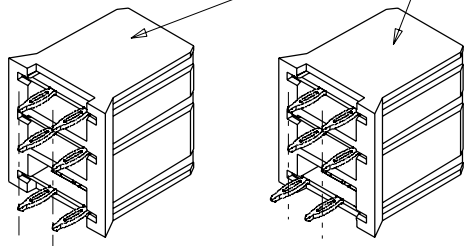

73656-100*

73656-200*

MIDPLANE OPTION

ASSEMBLY NUMBER	FINISH (SEE SHT 1)
73656-1000	SEE NOTE 2. (GOLD TAILS)
73656-2000	
73656-1001	SEE NOTE 3. (TIN/LEAD TAILS)
73656-2001	

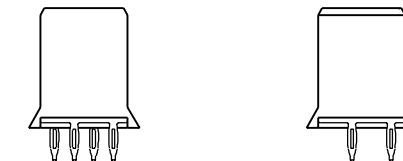
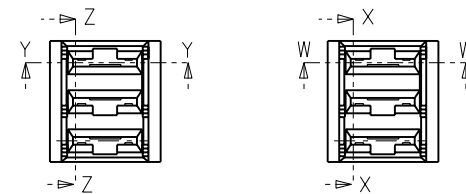

73656-200*

73656-100*

USE BACKPLANE MODULE HOLE REFERENCE PATTERN FROM SHEET 1

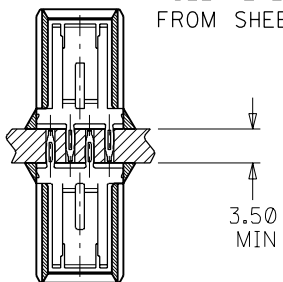

BACK-TO-BACK MOUNTING APPLICATION

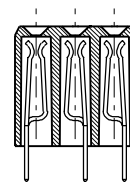

SECTION X-X
SECTION Z-Z
ROTATED 90° CW

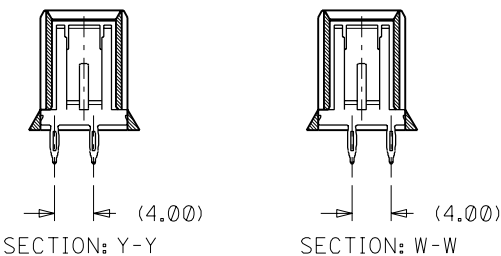

SECTION: Y-Y (4.00)

SECTION: W-W (4.00)

A

		D	SEE SHEET 1
		B	SEE SHEET 1
		A	SEE SHEET 1
LTR.	REVISIONS	LTR.	REVISIONS

DIMENSIONS SHOWN (METRIC) INCH	
UNLESS OTHERWISE SPECIFIED TOLERANCES: ANGULAR = 1/2°	
	INCH METRIC
3 PLACE	± N/A ---
2 PLACE	± N/A ± ---
1 PLACE	--- ± ---
DRAFT WHERE APPLICABLE MUST REMAIN WITHIN DIMENSIONS	
DRWG. BY: ELO	CHK'D. BY: SMR
APP'D. BY: CAB	SCALE: 2 : 1

REVISE ONLY ON CAD SYSTEM	
TITLE: SALES ASSY, HDM BACKPLANE POWER MODULE (PRESS FIT)	
MOLEX INCORPORATED LISLE, ILL. 60532 U.S.A.	SHEET NO. 2 DATE 98/05/21
PART NO. S73656X2 DGN	DRWG. NO. SDA-73656-*00*
FILE NAME: S73656X2 DGN	THIS DRAWING CONTAINS INFORMATION THAT IS PROPRIETARY TO MOLEX INC. AND SHOULD NOT BE USED WITHOUT WRITTEN PERMISSION.
DIV. DA	SIZE B