

**DC-20 GHz MMIC SPDT ABSORPTIVE SWITCH**
**FEATURES:**

- Low insertion loss: 2.1 dB at 20GHz
- High isolation: 42 dB at 20GHz
- Absorptive output in off-state
- Excellent low control voltage performance
- Available in die form

**GENERAL DESCRIPTION:**

The FMS2027 is a low-loss high-isolation broadband single-pole-double-throw Gallium Arsenide switch, designed on the FL05 0.5 $\mu$ m switch process from Filtronic. It offers absorptive properties from the output (50 Ohms termination).

This process technology offers leading-edge performance optimised for switch applications. The FMS2027 is developed for the broadband communications, instrumentation and electronic warfare markets.

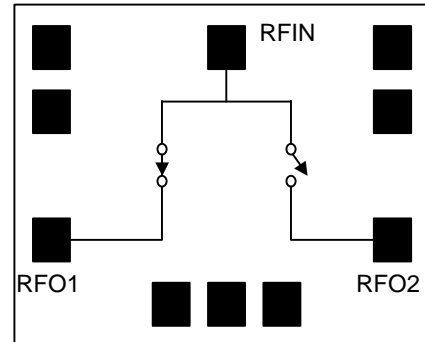
**FUNCTIONAL SCHEMATIC:**

**TYPICAL APPLICATIONS:**

- Broadband communications
- Test Instrumentation
- Fiber Optics
- Electronic warfare (ECM, ESM)

**ELECTRICAL SPECIFICATIONS (based on on-wafer measurements):**

Parameter	Conditions	Min	Typ	Max	Units
Insertion Loss	DC	-1	-0.85	-	dB
	10 GHz	-1.5	-1.3	-	dB
	15 GHz	-1.8	-1.6	-	dB
	20 GHz	-2.3	-2.1	-	dB
Isolation	DC-20 GHz	-	-42	-40	dB
Input Return Loss (ON state)	DC-20 GHz	-	-12	-10	dB
Output Return Loss (ON state)	DC-20 GHz	-	-16	-13	dB
Output Return Loss (OFF state)	DC-20 GHz	-	-22	-12	dB
P1dB	2 GHz	22	23	-	dBm
	10 GHz	21	22.5	-	dBm
	18 GHz	19	21	-	dBm
Switching speed	10% to 90% RF	-	17	-	ns
	90% to 10% RF	-	42	-	ns
	50% DC to 90% RF	-	27	-	ns
	50% DC to 10% RF	-	53	-	ns

Note:  $T_{AMBIENT} = 25^{\circ}C$ ,  $V_{ctrl} = 0V/-5V$ ,  $Z_{IN} = Z_{OUT} = 50\Omega$

**ABSOLUTE MAXIMUM RATINGS:**

PARAMETER	SYMBOL	ABSOLUTE MAXIMUM
Max Input Power	Pin	+38dBm
Control Voltage	Vctrl	-
Operating Temp	Toper	-40°C to +85°C
Storage Temp	Tstor	-55°C to +150°C

Note: Exceeding any one of these absolute maximum ratings may cause permanent damage to the device.

**TRUTH TABLE:**

CONTROL LINE		RF PATH	
A	B	RFIN-RFO1	RFIN-RFO2
-5V	0V	ON	OFF
0V	-5V	OFF	ON

Note: -5V  $\pm$  0.2V; 0V  $\pm$  0.2V

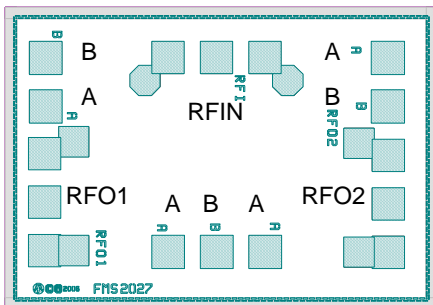
**PAD LAYOUT:**

Note:

<sup>1</sup>Co-ordinates are referenced from the bottom left hand corner of the die to the centre of bond pad opening

<sup>2</sup>Only one control line A and one control line B require connection

PAD NAME	DESCRIPTION
RFIN	RFIN
RFO1	RFOUT1
RFO2	RFOUT2
A	VA1
A	VA2
A	VA3
A	VA4
B	VB1
B	VB2
B	VB3

DIE SIZE ( $\mu\text{m}$ )	DIE THICKNESS ( $\mu\text{m}$ )	MIN. BOND PAD PITCH ( $\mu\text{m}$ )	MIN. BOND PAD OPENING ( $\mu\text{m} \times \mu\text{m}$ )
1336 x 934	100	150	94 x 94

**TYPICAL MEASURED PERFORMANCE ON WAFER:**

Note: Measurement Conditions  $V_{CTRL} = -5V$  (low) &  $0V$  (high),  $T_{AMBIENT} = 25^{\circ}C$ . Both arms RFO1 and RFO2 are symmetrical.

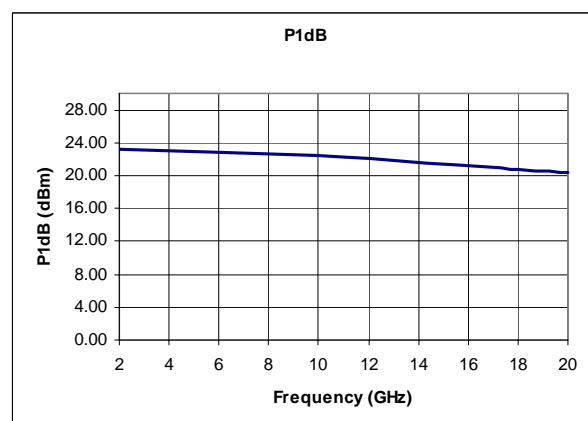
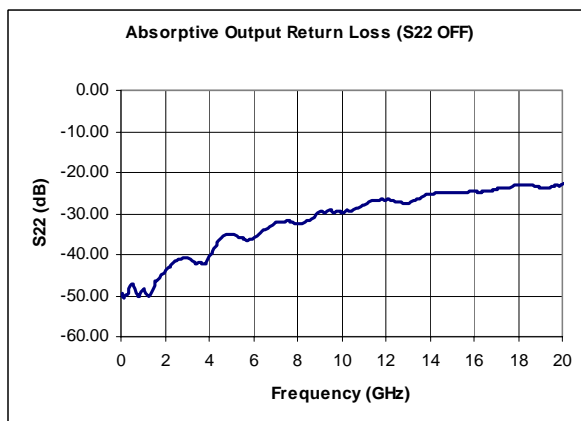
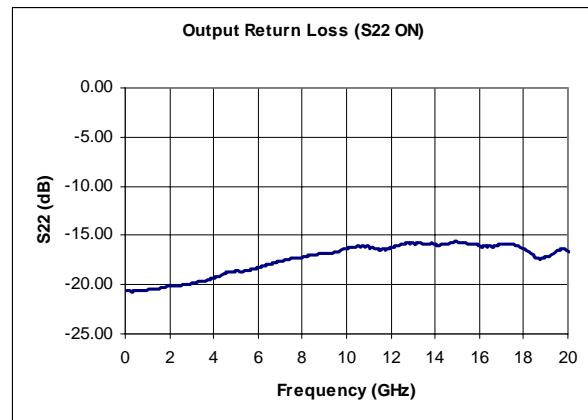
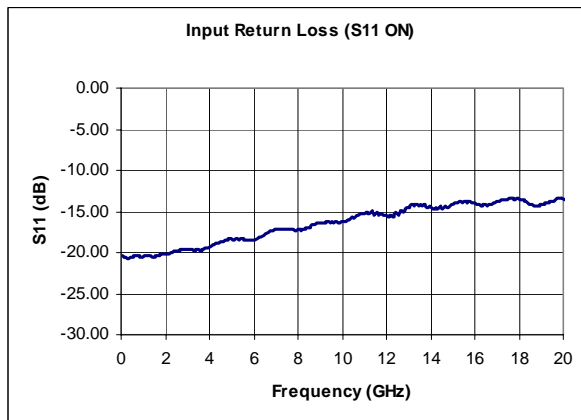
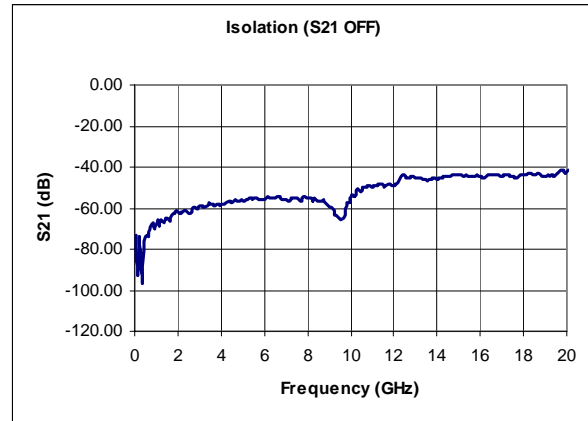
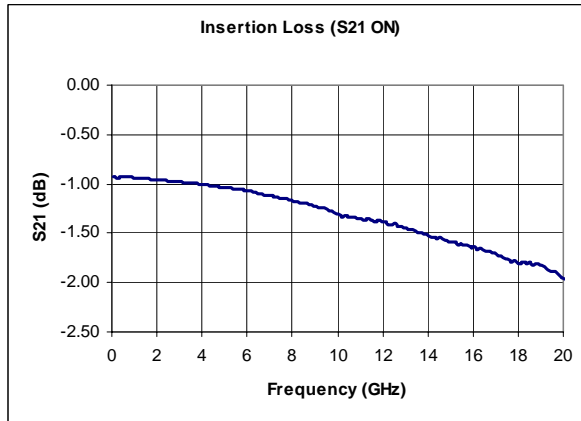

**TYPICAL PERFORMANCE FOR ON-WAFER MEASUREMENTS OVER TEMPERATURE:**

Note: Measurement Conditions  $V_{CTRL} = -5V$  (low) &  $0V$  (high),  $T_{AMBIENT}$  as indicated. Both arms RFO1 and RFO2 are symmetrical.

—  $T_{AMBIENT} = 25^{\circ}C$      
 - - -  $T_{COLD} = -40^{\circ}C$      
 ⋯  $T_{HOT} = +85^{\circ}C$

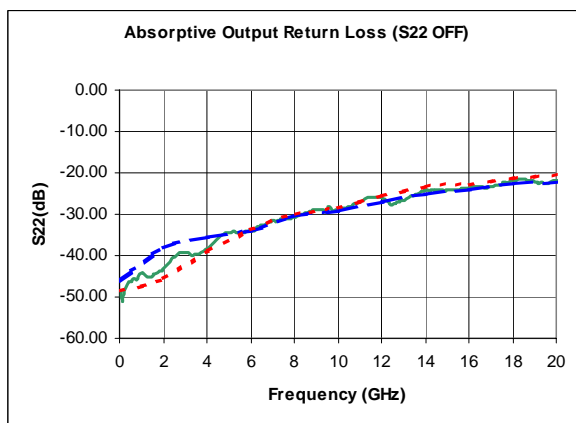
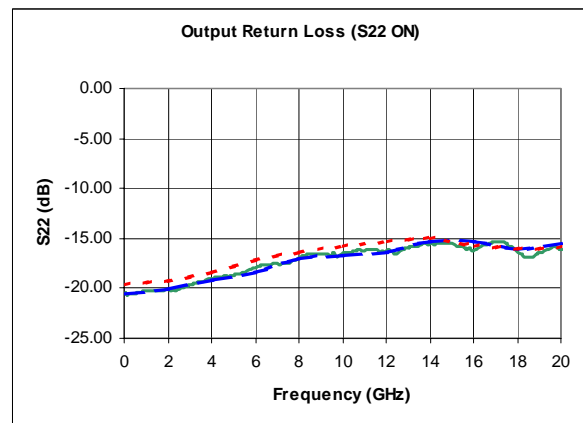
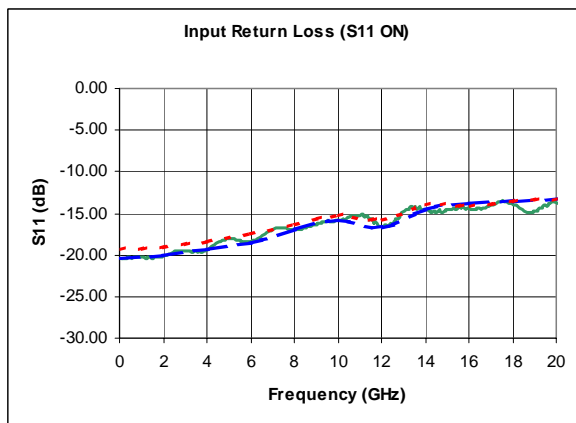
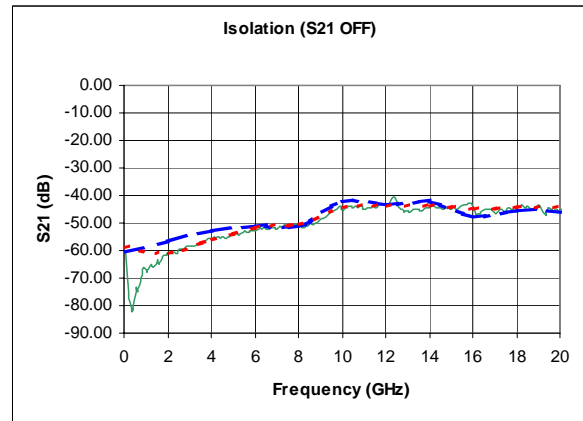
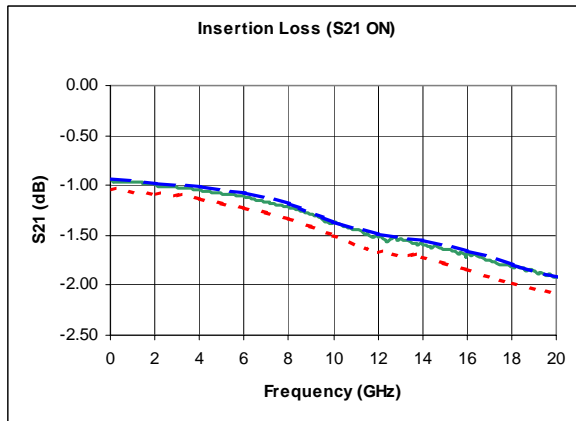

**PREFERRED ASSEMBLY INSTRUCTIONS:**

GaAs devices are fragile and should be handled with great care. Specially designed collets should be used where possible.

The back of the die is metallised and the recommended mounting method is by the use of solder or conductive epoxy. If epoxy is selected then it should be applied to the attachment surface uniformly and sparingly to avoid encroachment of epoxy on to the top face of the die and ideally should not exceed half the chip height. For automated dispense Ablestick LMISR4 is recommended and for manual dispense Ablestick 84-1 LMI or 84-1 LMIT are recommended. These should be cured at a temperature of 150°C for 1 hour in an oven especially set aside for epoxy curing only. If possible the curing oven should be flushed with dry nitrogen.

This part has gold (Au) bond pads requiring the use of gold (99.99% pure) bondwire. It is recommended that 25.4µm diameter gold wire be used. Thermosonic ball bonding is preferred. A nominal stage temperature of 150°C and a bonding force of 40g has been shown to give effective results for 25µm wire. Ultrasonic energy shall be kept to a minimum. For this bonding technique, stage temperature should not be raised above 200°C and bond force should not be raised above 60g. Thermosonic wedge bonding and thermocompression wedge bonding can also be used to achieve good wire bonds.

Bonds should be made from the die first and then to the mounting substrate or package. The physical length of the bondwires should be minimised especially when making RF or ground connections.

**HANDLING PRECAUTIONS:**

To avoid damage to the devices care should be exercised during handling. Proper Electrostatic Discharge (ESD) precautions should be observed at all stages of storage, handling, assembly, and testing. These devices should be treated as Class 1A (250-500 V) as defined in JEDEC Standard No. 22-A114. Further information on ESD control measures can be found in MIL-STD-1686 and MIL-HDBK-263.

**APPLICATION NOTES & DESIGN DATA:**

Application Notes and design data including S-parameters are available on request.

**DISCLAIMERS:**

This product is not designed for use in any space based or life sustaining/supporting equipment.

**ORDERING INFORMATION:**

PART NUMBER	DESCRIPTION
FMS2027-000	Die in Waffle-pack (Gel-pak available on request)