

POWER RELAY

1 POLE - 16A Sealed Type

FTR-K1 Series

■ FEATURES

- 1 pole
 - 16A
 - 1 form A / 1 form C
 - Coil sensitive 400mW
 - High insulation in small package (between coil and contacts)
 - Insulation distance: 10mm min.
 - Dielectric strength: 5,000VAC
 - Surge strength: 10,000V
 - Conform to UL1446 Class F coil insulation system
 - Cadmium free contacts
 - RoHS compliant
- Please see page 7 for more information



■ PARTNUMBER INFORMATION

[Example] FTR-K1 C K 005 W - KW
 (a) (b) (c) (d) (e) (f)

(a)	Relay type	FTR-K1: FTR-K1 Series
(b)	Contact configuration	A : 1 form A C : 1 form C
(c)	Coil type	K : Standard type (400mW) / flux free
(d)	Coil rated voltage	005 : 5.....48 VDC Coil rating table at page 3
(e)	Contact material	W : AgSnO ₂
(f)	Special type	KW : Sealed type

Actual marking does not carry the type name : "FTR"

E.g.: Ordering code: FTR-K1CK005W-KW Actual marking: K1CK005W-KW

FTR-K1 SERIES

■ SPECIFICATION

16A type

Item	FTR-K1 CK () W-KW		FTR-K1 AK () W-KW
Contact Data	Configuration		1 form C
	Construction		Single
	Material		AgSnO ₂
	Resistance (initial)		Maximum 100mΩ at 1A, 6VDC
	Contact rating (resistive)		16A, 250VAC
	Max. carrying current *1		20A
	Max. switching voltage		440VAC
	Max. switching power		4,000VA
	Min. switching load *2		100mA, 5VDC
Life	Mechanical		20 x 10 ⁶ operations minimum
	Electrical	Rating resistive load	10 x 10 ³ operations minimum 20 x 10 ³ operations minimum
Coil Data	Rated power (20 °C)		400 / 430 mW
	Operating temperature range		-40 °C to +85 °C (no frost)
Timing Data	Operate (at nominal voltage)		≤ 15ms (no bounce, no diode)
	Release (at nominal voltage)		≤ 5ms (no bounce, no diode)
Insulation	Resistance (initial)		≥ 1,000MΩ at 500VDC
	Dielectric strength	Open contacts	1,000VAC (50/60Hz) 1min
		Contacts to coil	5,000VAC (50/60Hz) 1min
	Surge strength	Coil to contacts	10,000V / 1.2 x 50μs standard wave
	Clearance		10mm
	Creepage		10mm
	EN61810-1, VDE0435	Voltage	250
		Pollution degree	3
		Material group	III a
	Category	C / 250V	
Other	Vibration resistance	Misoperation≥1us	10 to 55Hz double amplitude 0.7mm
		Endurance	10 to 55Hz double amplitude 1.5mm
	Shock	Misoperation≥1us	100m/s ² (11 ± 1ms)
		Endurance	1,000m/s ² (6 ± 1ms)
	Weight		Approximately 13g

* 1: Need to consider the heat from PCB when max. current is more than 10A.

* 2: Minimum switching loads mentioned above are reference values. Please perform the confirmation test with actual load before production since reference values may vary according to switching frequencies, environmental conditions and expected reliability levels.

FTR-K1 SERIES

■ COIL RATING

Coil Code	Rated Coil Voltage (VDC)	Coil Resistance +/- 10% (Ohm)	Must Operate Voltage (VDC) *	Must Release-Voltage (VDC) *	Max. Coil Voltage (VDC)	Rated Power (mW)
005	5	62	3.5	0.5	12.2	400
006	6	90	4.2	0.6	14.7	
009	9	202	6.3	0.9	22.0	
012	12	360	8.4	1.2	29.4	
018	18	810	12.6	1.8	44.1	
022	22	1210	15.4	2.2	53.9	
024	24	1440	16.8	2.4	58.8	
028	28	1960	19.6	2.8	68.6	
048	48	5360	33.6	4.8	117.6	430

Note: All values in the table are valid for 20°C and zero contact current.

* Specified operate values are valid for pulse wave voltage.

■ SAFETY STANDARDS

Type	Compliance	Contact rating
UL	508 E 63614	Flammability: UL 94-VII (plastics)
		UL-94-V0
VDE	0435; 40013848	16A, 250VAC cos Ø=1 85 °C 10.000 ops.

FTR-K1 SERIES

CHARACTERISTIC DATA

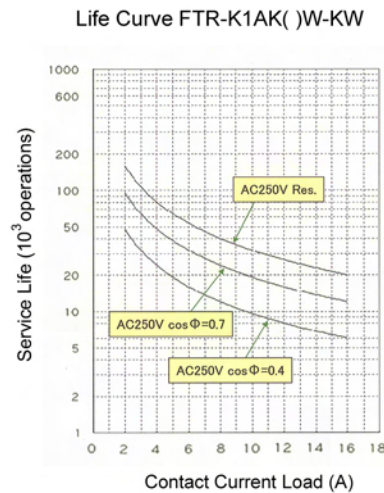
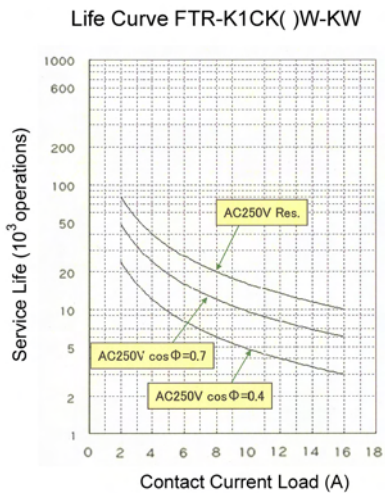
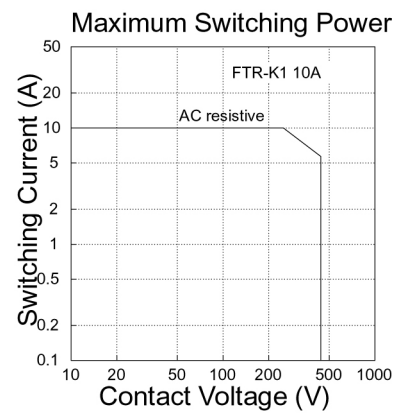
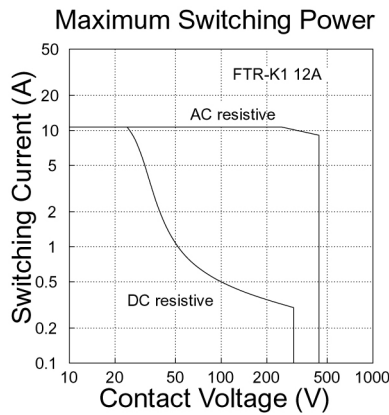
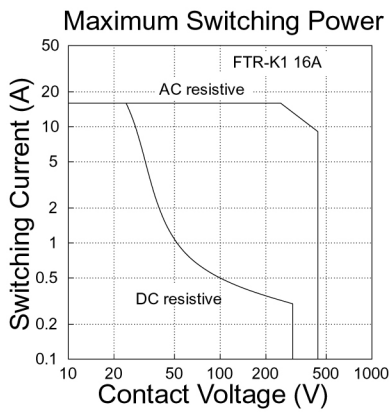
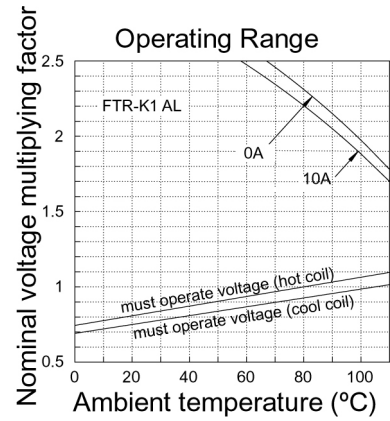
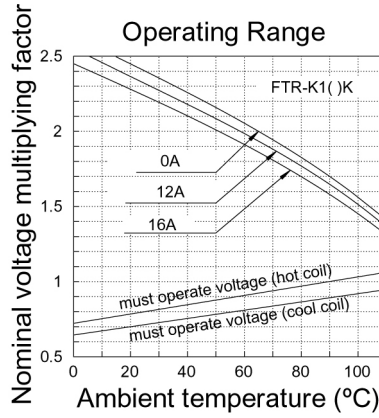
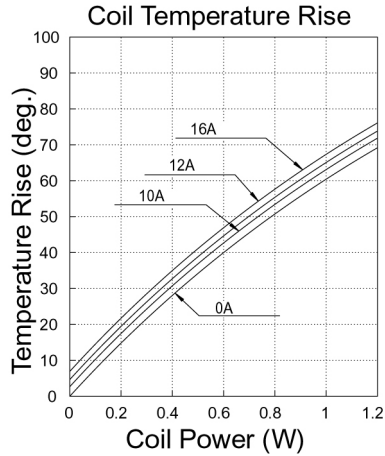

FTR-K1 SERIES

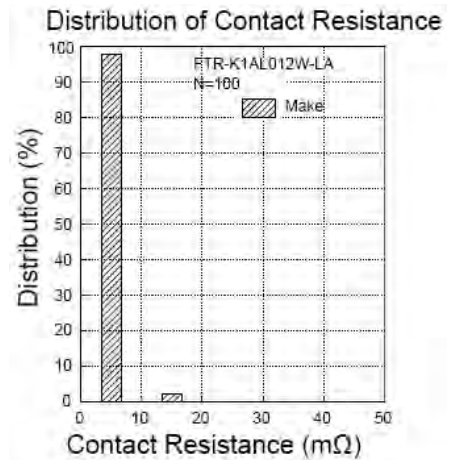
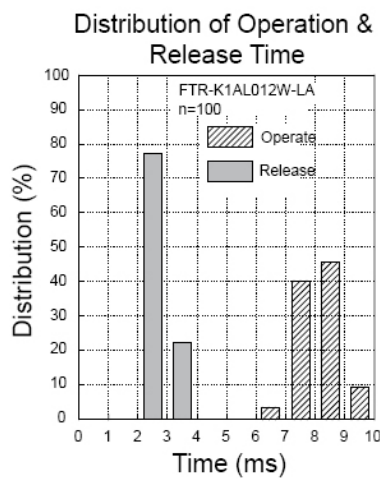
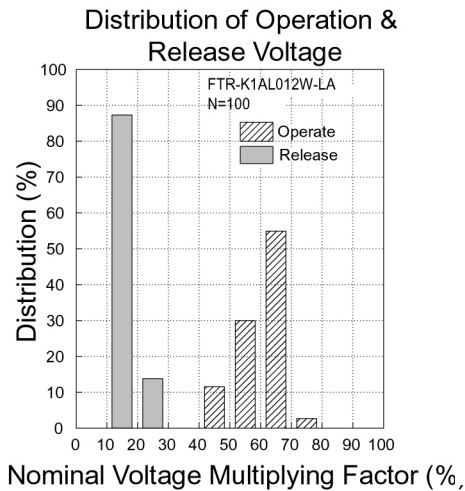
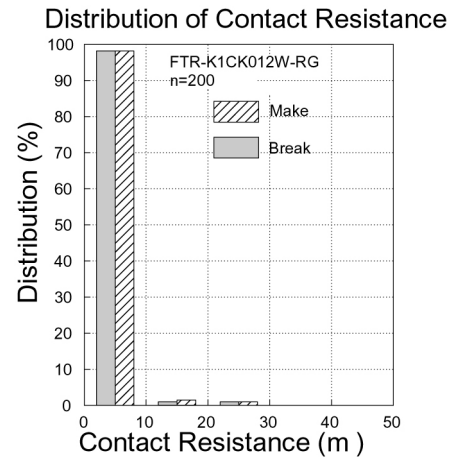
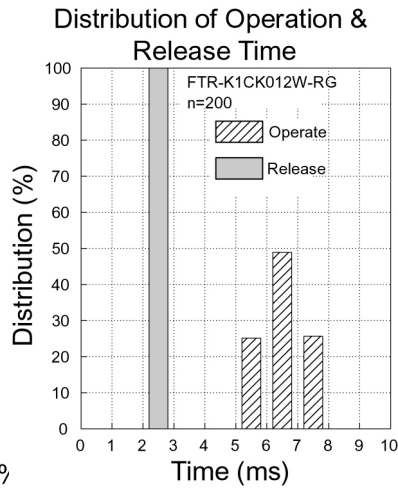
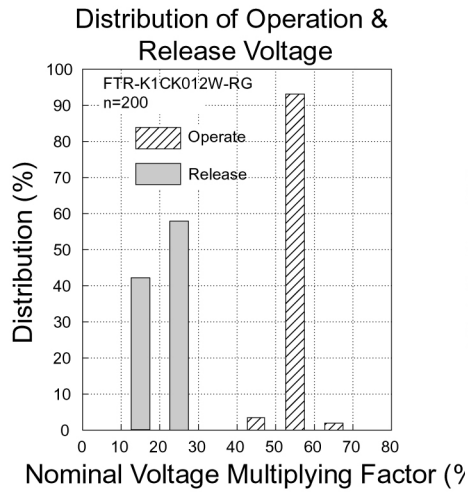

FTR-K1 SERIES

■ DIMENSIONS

• Dimensions

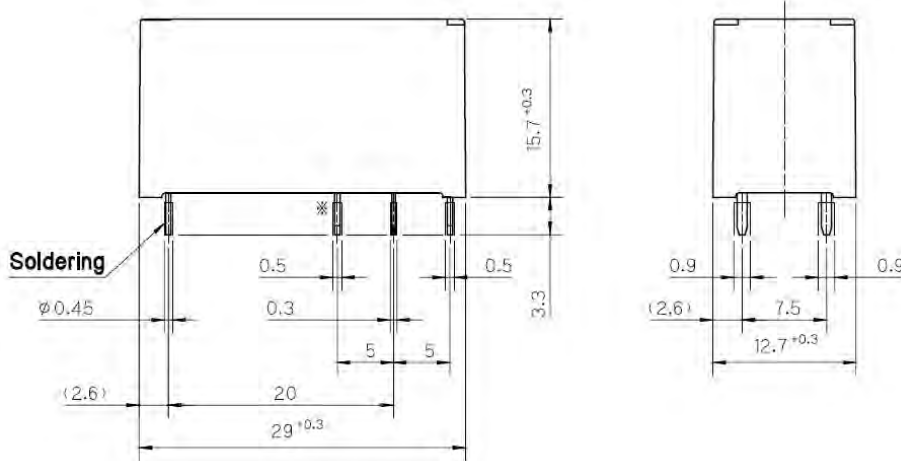

• Drilling plan (BOTTOM VIEW)

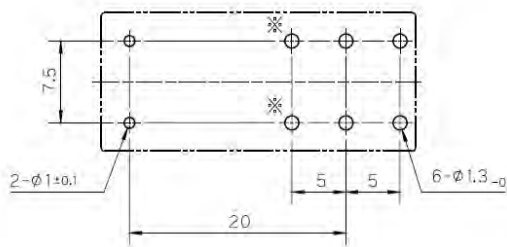

• Wiring diagram (BOTTOM VIEW)

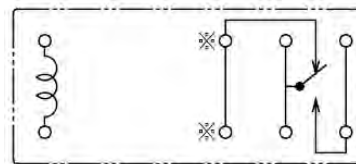

Unit: mm

Note: In case of 1 form A, there is no "stationary" contact arm.

RoHS Compliance and Lead Free Information

1. General Information

- All signal and power relays produced by Fujitsu Components are compliant with RoHS directive 2002/95EC including amendments.
- Cadmium as used in electrical contacts is exempted from the RoHS directives on October 21st, 2005. (Amendment to Directive 2002/95/EC)
- All of our signal and power relays are lead-free. Please refer to Lead-Free Status Info for older date codes at: <http://www.fujitsu.com/us/downloads/MICRO/fcai/relays/lead-free-letter.pdf>
- Lead free solder plating on relay terminals is Sn-3.0Ag-0.5Cu, unless otherwise specified. This material has been verified to be compatible with PbSn assembly process.

2. Recommended Lead Free Solder Profile

- Recommended solder Sn-3.0Ag-0.5Cu.

Flow Solder condition:

Pre-heating: maximum 120°C
Soldering: dip within 5 sec. at
260°C solder bath

Solder by Soldering Iron:

Soldering Iron
Temperature: maximum 360°C
Duration: maximum 3 sec.

We highly recommend that you confirm your actual solder conditions

3. Moisture Sensitivity

- Moisture Sensitivity Level standard is not applicable to electromechanical relays, unless otherwise indicated.

4. Tin Whiskers

- Dipped SnAgCu solder is known as presenting a low risk to tin whisker development. No considerable length whisker was found by our in house test.

Fujitsu Components International Headquarter Offices

Japan

Fujitsu Component Limited
Gotanda-Chuo Building
3-5, Higashigotanda 2-chome, Shinagawa-ku
Tokyo 141, Japan
Tel: (81-3) 5449-7010
Fax: (81-3) 5449-2626
Email: promothq@ft.ed.fujitsu.com
Web: www.fcl.fujitsu.com

North and South America

Fujitsu Components America, Inc.
250 E. Caribbean Drive
Sunnyvale, CA 94089 U.S.A.
Tel: (1-408) 745-4900
Fax: (1-408) 745-4970
Email: components@us.fujitsu.com
Web: <http://us.fujitsu.com/components>

Europe

Fujitsu Components Europe B.V.
Diamantlaan 25
2132 WV Hoofddorp
Netherlands
Tel: (31-23) 5560910
Fax: (31-23) 5560950
Email: info@fceu.fujitsu.com
Web: emea.fujitsu.com/components/

Asia Pacific

Fujitsu Components Asia Ltd.
102E Pasir Panjang Road
#01-01 Citilink Warehouse Complex
Singapore 118529
Tel: (65) 6375-8560
Fax: (65) 6273-3021
Email: fcal@fcal.fujitsu.com
Web: <http://www.fujitsu.com/sg/services/micro/components/>

©2010 Fujitsu Components Europe B.V. All rights reserved. All trademarks or registered trademarks are the property of their respective owners.

The contents, data and information in this datasheet are provided by Fujitsu Component Ltd. as a service only to its user and only for general information purposes.

The use of the contents, data and information provided in this datasheet is at the users' own risk.

Fujitsu has assembled this datasheet with care and will endeavor to keep the contents, data and information correct, accurate, comprehensive, complete and up to date.

Fujitsu Components Europe B.V. and affiliated companies do however not accept any responsibility or liability on their behalf, nor on behalf of its employees, for any loss or damage, direct, indirect or consequential, with respect to this datasheet, its contents, data, and information and related graphics and the correctness, reliability, accuracy, comprehensiveness, usefulness, availability and completeness thereof.

Nor do Fujitsu Components Europe B.V. and affiliated companies accept on their behalf, nor on behalf of its employees, any responsibility or liability for any representation or warrant of any kind, express or implied, including warranties of any kind for merchantability or fitness for particular use, with respect to these datasheets, its contents, data, information and related graphics and the correctness, reliability, accuracy, comprehensiveness, usefulness, availability and completeness thereof. Rev. April 13, 2010