

**PLEASE CHECK WWW.MOLEX.COM FOR LATEST PART INFORMATION**

**Part Number:** [0877592874](#)  
**Status:** **Active**  
**Overview:** milligrid  
**Description:** 2.00mm (.079") Pitch Milli-Grid™ Header, Surface Mount, Vertical, 28 Circuits, 0.38µm (15µ") Gold (Au) Selective Plating, with Pick-and-Place Cap, Tape and Reel Packaging, without Press-fit Plastic Pegs, Lead-free

**Documents:**

[3D Model](#) [Product Specification PS-87761-100 \(PDF\)](#)  
[Drawing \(PDF\)](#) [RoHS Certificate of Compliance \(PDF\)](#)

**Agency Certification**

UL E29179

**General**

Product Family PCB Headers  
 Series [87759](#)  
 Application Board-to-Board  
 Overview [milligrid](#)  
 Product Name Milli-Grid™

**Physical**

Breakaway Yes  
 Circuits (Loaded) 28  
 Circuits (maximum) 28  
 Color - Resin Black  
 Durability (mating cycles max) 100  
 First Mate / Last Break No  
 Flammability 94V-0  
 Glow-Wire Compliant No  
 Guide to Mating Part No  
 Keying to Mating Part None  
 Lock to Mating Part None  
 Mated Height (in) 0.150 In  
 Mated Height (mm) 3.80 mm  
 Material - Metal Phosphor Bronze  
 Material - Plating Mating Gold  
 Material - Plating Termination Tin  
 Material - Resin Nylon  
 Number of Rows 2  
 Orientation Vertical  
 PCB Locator No  
 PCB Retention None  
 Packaging Type Embossed Tape on Reel  
 Pitch - Mating Interface (in) 0.079 In  
 Pitch - Mating Interface (mm) 2.00 mm  
 Pitch - Term. Interface (in) 0.079 In  
 Pitch - Term. Interface (mm) 2.00 mm  
 Plating min: Mating (µin) 15  
 Plating min: Mating (µm) 0.38  
 Polarized to Mating Part No  
 Polarized to PCB No  
 Robotic Placement Pick and Place Cap  
 Shrouded No  
 Stackable No  
 Temperature Range - Operating -55°C to +105°C

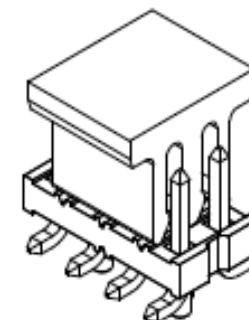

image - Reference only

Series

**EU RoHS**

**ELV and RoHS Compliant**  
**REACH SVHC Contains SVHC: No**  
**Halogen-Free Status**  
**Not Reviewed**

**China RoHS**



**Need more information on product environmental compliance?**

Email [productcompliance@molex.com](mailto:productcompliance@molex.com)  
 For a multiple part number RoHS Certificate of Compliance, [click here](#)

Please visit the [Contact Us](#) section for any non-product compliance questions.

**Search Parts in this Series**

[87759Series](#)

**Mates With**

[79107](#) Milli-Grid™ Receptacle, Vertical, Through Hole. [79108](#) Milli-Grid™ Flex-to-Board, Vertical Receptacle. Milli-Grid™ Receptacle, Surface Mount. [79109](#). [87381](#)

Termination Interface: Style

Surface Mount

**Electrical**

Current - Maximum per Contact  
Voltage - Maximum

2A  
125V

**Solder Process Data**

Lead-free Process Capability  
Process Temperature max. C

Reflow Capable (SMT only)  
250

**Material Info**

**Reference - Drawing Numbers**

Packaging Specification  
Product Specification  
Sales Drawing

PK-89990-485  
PS-87761-100  
SD-87759-117

This document was generated on 05/25/2010

**PLEASE CHECK [WWW.MOLEX.COM](http://WWW.MOLEX.COM) FOR LATEST PART INFORMATION**

F

E

D

C

B

A

F

E

D

C

B

A

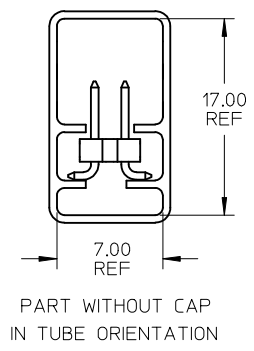
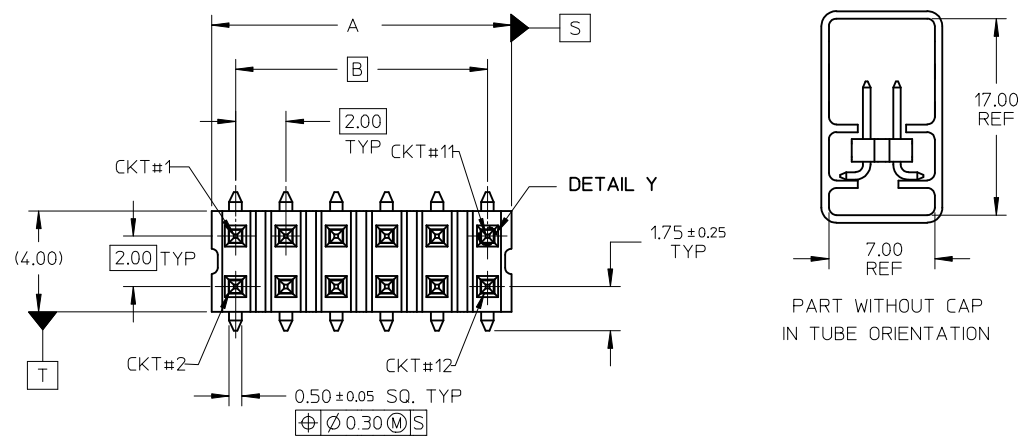

- NOTE:
- MATERIAL:  
HSG & CAP - NYLON, GLASS FILLED  
UL 94V-0, COLOUR BLACK  
  
PIN - 0.50 SQ PHOSPHOR BRONZE
  - PLATING:  
0.38um MIN GOLD PLATE AT CONTACT AREA,  
TIN PLATE AT SOLDER AREA,  
BOTH OVER NICKEL UNDERPLATE
  - PIN PUSHOUT FORCE: 1KG MIN IN EITHER DIRECTION
  - PRODUCT SPEC PS-87761-100 APPLIES.
  - BEND DEPRESSION IS ACCEPTABLE SO LONG AS IT DOES NOT AFFECT THE OVERALL COPLANARITY OF TAIL.
  - COPLANARITY IS TO BE MEASURED BY RESTING THE SOLDER TAIL ON A FLAT SURFACE.
  - CAP TO BE LOCATED AS CENTRAL OF PART AS POSSIBLE  
TOP SURFACE OF CAP TO BE FLAT FOR THE PURPOSE OF PICK & PLACE BY VACUUM SUCTION NOZZLE.
  - FOR ILLUSTRATION PURPOSES, 12CKT IS SHOWN.
  - CKT 4 & 6 IS CUT FROM CKT 8 & 12 RESPECTIVELY  
ROUGH EDGES ARE EXPECTED ALONG THE CUTTING EDGES.
  - PART TO BE PACKED IN TRAY ONLY.
  - TUBE LENGTH IS 560MM REF STANDARD.

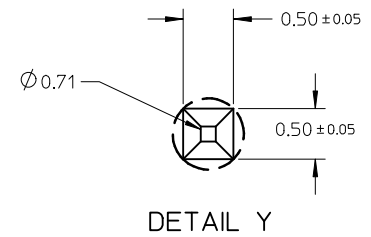
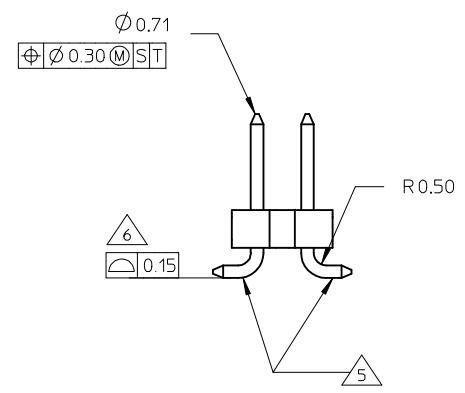
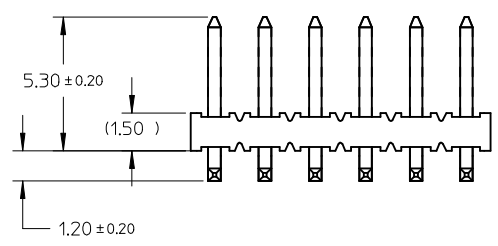

ADD. OPTION EC NO: S2009-0510 DRWN:ATSEE CHKD:SKANG APPR:MLONG 2009/01/23 2009/02/09 2009/02/17	QUALITY SYMBOLS	GENERAL TOLERANCES (UNLESS SPECIFIED)		DIMENSION STYLE	SCALE	DESIGN UNITS	THIRD ANGLE PROJECTION	
	▽=0 ∇=0	mm	INCH	MM ONLY	NTS	METRIC		
		4 PLACES ± --- ± ---	3 PLACES ± --- ± ---	DRAWN BY KSEE	DATE 2003/12/12	TITLE CUSTOM HEADER MGRID, 2MM DUAL ROW HDR. SMT		
		2 PLACES ± 0.2 ± ---	1 PLACE ± --- ± ---	CHECKED BY KCL ING	DATE 2004/01/12	MOLEX INCORPORATED		
		ANGULAR ± 3 °		APPROVED BY SKTOH	DATE 2004/01/12	DOCUMENT NO. SD-87759-117		
		DRAFT WHERE APPLICABLE MUST REMAIN WITHIN DIMENSIONS		MATERIAL NO. SEE TABLE	SHEET NO. 1 OF 6			
B2	REV			SIZE A3	THIS DRAWING CONTAINS INFORMATION THAT IS PROPRIETARY TO MOLEX INCORPORATED AND SHOULD NOT BE USED WITHOUT WRITTEN PERMISSION			

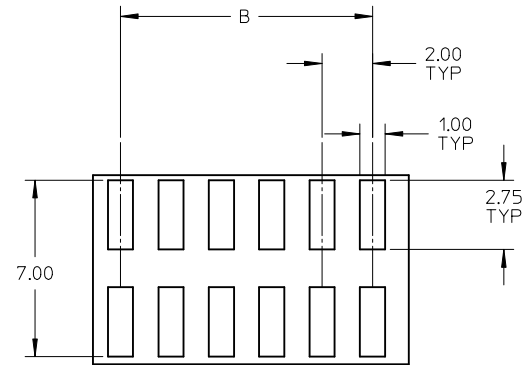
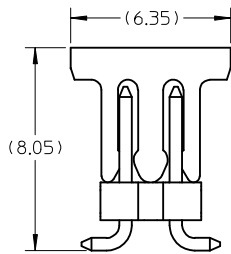
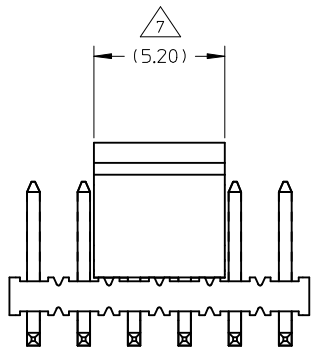

RECOMMENDED SOLDER PAD LAYOUT

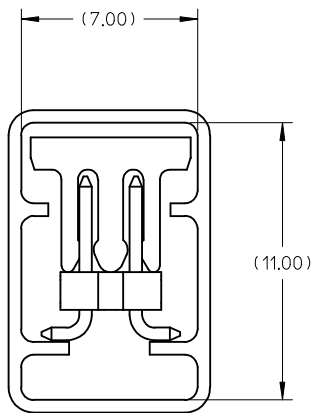

ADD. OPTION EC NO: S2009-0510 DRWN:ATSEE 2009/01/23 CHKD:SKANG 2009/02/09 APPR:MLONG 2009/02/17	QUALITY SYMBOLS ▽=0 ◻=0	GENERAL TOLERANCES (UNLESS SPECIFIED) mm INCH	DIMENSION STYLE MM ONLY	SCALE NTS	DESIGN UNITS METRIC	THIRD ANGLE PROJECTION	
	4 PLACES ± --- ± --- 3 PLACES ± --- ± --- 2 PLACES ± 0.2 ± --- 1 PLACE ± --- ± ---	DRAWN BY DATE KSEE 2003/12/12 CHECKED BY DATE KCLING 2004/01/12 APPROVED BY DATE SKTOH 2004/01/12	TITLE CUSTOM HEADER MGRID, 2MM DUAL ROW HDR. SMT				
	ANGULAR ± 3 °	MATERIAL NO.	MOLEX INCORPORATED				
	DRAFT WHERE APPLICABLE MUST REMAIN WITHIN DIMENSIONS	SEE TABLE	DOCUMENT NO.	SD-87759-117			
B2	REV DESCRIPTION	SIZE A3	THIS DRAWING CONTAINS INFORMATION THAT IS PROPRIETARY TO MOLEX INCORPORATED AND SHOULD NOT BE USED WITHOUT WRITTEN PERMISSION				

EMBOSSED CARRIER TAPE TYPE "A"

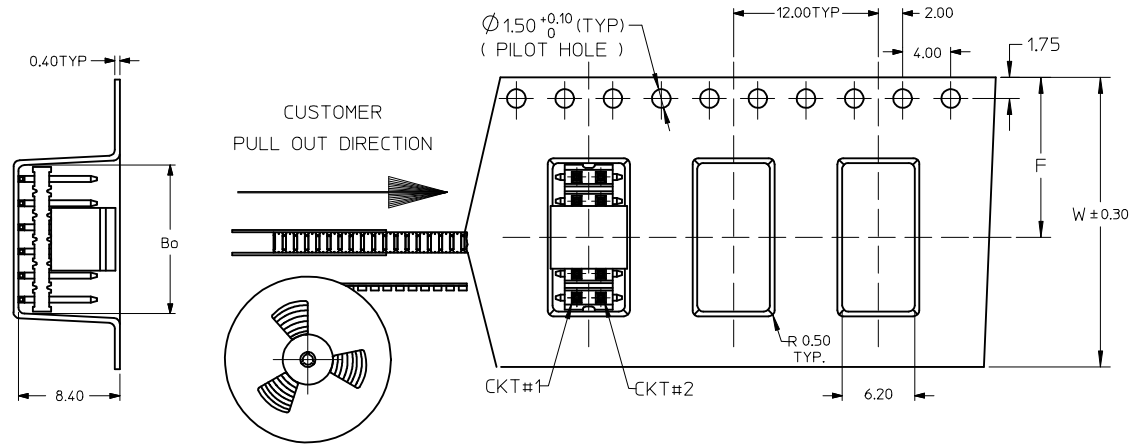

NOTES:

12. LEADER AND TRAILER TAPE



13. PEELING OFF FORCE OF THE TOP TAPE: 20-80gf.  
(PEELING DIRECTION AS SHOWN IN FOLLOWING FIGURE)

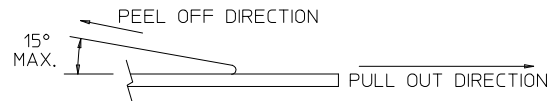

- 14. PACKAGING STANDARD IS AS PER EIA-481.
- 15. TAPE & REEL QUANTITY = 750 PCS/REEL
- 16. THE TAPE IS TREATED FOR ANTI-STATIC

ADD. OPTION EC NO: S2009-0510 DRWN:ATSEE CHKD:SKANG APPR:MLONG	2009/01/23 2009/02/09 2009/02/17	DESCRIPTION REV	QUALITY SYMBOLS	GENERAL TOLERANCES (UNLESS SPECIFIED)	DIMENSION STYLE	SCALE	DESIGN UNITS	THIRD ANGLE PROJECTION
			$\nabla=0$ $\square=0$	mm    INCH 4 PLACES ± --- ± --- 3 PLACES ± --- ± --- 2 PLACES ± 0.2 ± --- 1 PLACE ± --- ± --- ANGULAR ± 3°	MM ONLY	NTS	METRIC	
				DRAFT WHERE APPLICABLE MUST REMAIN WITHIN DIMENSIONS	DRAWN BY: KSEE    DATE: 2003/12/12 CHECKED BY: KCLING    DATE: 2004/01/12 APPROVED BY: SKTOH    DATE: 2004/01/12	TITLE	CUSTOM HEADER MGRID, 2MM DUAL ROW HDR. SMT	
				SEE TABLE	MATERIAL NO.    DOCUMENT NO.	MOLEX INCORPORATED SD-87759-117		
B2					SIZE A3	THIS DRAWING CONTAINS INFORMATION THAT IS PROPRIETARY TO MOLEX INCORPORATED AND SHOULD NOT BE USED WITHOUT WRITTEN PERMISSION		

EMBOSSED CARRIER TAPE TYPE "B"

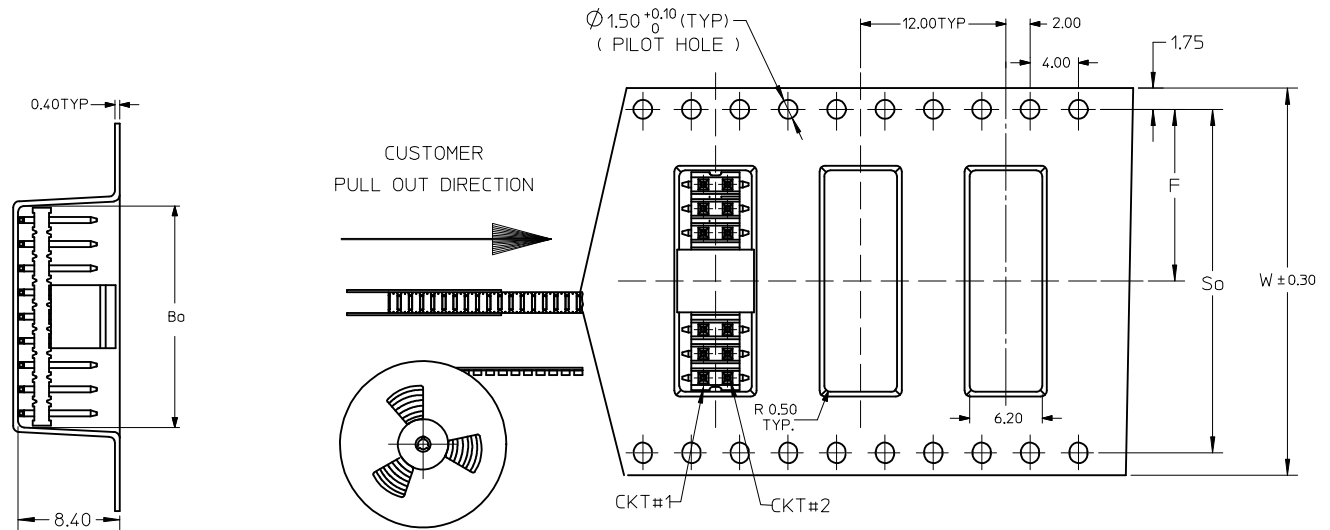

ADD. OPTION EC NO: S2009-0510 DRWN:ATSEE 2009/01/23 CHKD:SKANG 2009/02/09 APPR:MLONG 2009/02/17	QUALITY SYMBOLS ▽=0 ◻=0	GENERAL TOLERANCES (UNLESS SPECIFIED) mm INCH 4 PLACES ± --- ± --- 3 PLACES ± --- ± --- 2 PLACES ± 0.2 ± --- 1 PLACE ± --- ± --- ANGULAR ± 3 °	DIMENSION STYLE MM ONLY DRAWN BY DATE KSEE 2003/12/12 CHECKED BY DATE KCLING 2004/01/12 APPROVED BY DATE SKTOH 2004/01/12	SCALE NTS DESIGN UNITS METRIC THIRD ANGLE PROJECTION	TITLE CUSTOM HEADER MGRID, 2MM DUAL ROW HDR. SMT MOLEX INCORPORATED DOCUMENT NO. SD-87759-117	SHEET NO. 4 OF 6
	DRAFT WHERE APPLICABLE MUST REMAIN WITHIN DIMENSIONS	MATERIAL NO. SEE TABLE	SIZE A3 THIS DRAWING CONTAINS INFORMATION THAT IS PROPRIETARY TO MOLEX INCORPORATED AND SHOULD NOT BE USED WITHOUT WRITTEN PERMISSION			
	REV B2	DESCRIPTION				

THIS TYPE OF CARRIER IS FOR CKT SIZE 8 AND BELOW.

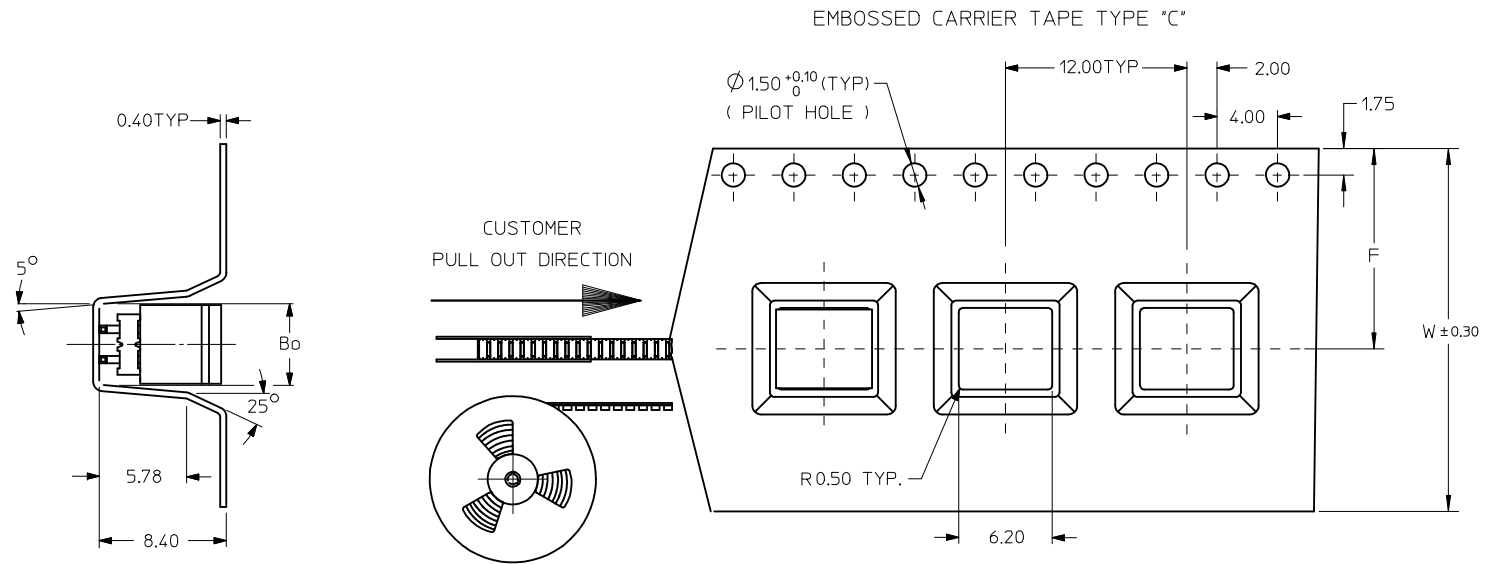

<b>ADD. OPTION</b> EC NO: S2009-0510 DRWN:ATSEE 2009/01/23 CHKD:SKANG 2009/02/09 APPR:MLONG 2009/02/17	QUALITY SYMBOLS ▽=0 ◻=0	GENERAL TOLERANCES (UNLESS SPECIFIED)		DIMENSION STYLE <b>MM ONLY</b>	SCALE <b>NTS</b>	DESIGN UNITS <b>METRIC</b>	THIRD ANGLE PROJECTION	
			mm	INCH	DRAWN BY KSEE	DATE 2003/12/12	TITLE <b>CUSTOM HEADER          MGRID, 2MM DUAL ROW HDR.          SMT</b>	
		4 PLACES	± ---	± ---	CHECKED BY KCLING	DATE 2004/01/12	<b>MOLEX INCORPORATED</b>	
		3 PLACES	± ---	± ---	APPROVED BY SKTOH	DATE 2004/01/12	DOCUMENT NO. <b>SD-87759-117</b>	SHEET NO. <b>5 OF 6</b>
2 PLACES	± 0.2	± ---	ANGULAR ± 3 °		<b>SEE TABLE</b>			
1 PLACE	± ---	± ---	DRAFT WHERE APPLICABLE MUST REMAIN WITHIN DIMENSIONS		THIS DRAWING CONTAINS INFORMATION THAT IS PROPRIETARY TO MOLEX INCORPORATED AND SHOULD NOT BE USED WITHOUT WRITTEN PERMISSION			

	10	9	8	7	6	5	4	3	2	1		
	PART NUMBER WITHOUT CAP IN TUBE	PART NUMBER WITH CAP IN TUBE	PART NUMBER WITH CAP IN TAPE AND REEL.	CKT SIZE	VOID CKTS	A	B	Bo	F	So	W	EMBOSSED TYPE
F	87759-0414 $\triangle 9$ $\triangle 10$	87759-0464	87759-0474	4	--	NA	2.00	5.40	11.50	-	24.00	C
	87759-0614 $\triangle 9$	87759-0664	87759-0674	6	--	NA	4.00	7.20	11.50	-	24.00	C
	87759-0814	87759-0864	87759-0874	8	--	7.90	6.00	8.20	11.50	-	24.00	C
	87759-1014	87759-1064	87759-1074	10	--	9.90	8.00	10.20	11.50	-	24.00	A
	87759-1002 $\triangle A$	87759-1003 $\triangle A$	87759-1004 $\triangle A$	10	10	9.90	8.00	10.20	11.50	-	24.00	A
	87759-1214	87759-1264	87759-1274	12	--	11.90	10.00	12.20	11.50	-	24.00	A
E	87759-1414	87759-1464	87759-1474	14	--	13.90	12.00	14.20	11.50	-	24.00	A
	87759-1614	87759-1664	87759-1674	16	--	15.90	14.00	16.20	14.20	28.40	32.00	B
	87759-1814	87759-1864	87759-1874	18	--	17.90	16.00	18.20	14.20	28.40	32.00	B
	87759-2014	87759-2064	87759-2074	20	--	19.90	18.00	20.20	14.20	28.40	32.00	B
	87759-2214	87759-2264	87759-2274	22	--	21.90	20.00	22.20	20.20	40.40	44.00	B
D	87759-2414	87759-2464	87759-2474	24	--	23.90	22.00	24.20	20.20	40.40	44.00	B
	87759-2614	87759-2664	87759-2674	26	--	25.90	24.00	26.20	20.20	40.40	44.00	B
	87759-2814	87759-2864	87759-2874	28	--	27.90	26.00	28.20	20.20	40.40	44.00	B
	87759-3014	87759-3064	87759-3074	30	--	29.90	28.00	30.20	20.20	40.40	44.00	B
	87759-3214	87759-3264	87759-3274	32	--	31.90	30.00	32.20	20.20	40.40	44.00	B
	87759-3414	87759-3464	87759-3474	34	--	33.90	32.00	34.20	26.20	52.40	56.00	B
	87759-3614	87759-3664	87759-3674	36	--	35.90	34.00	36.20	26.20	52.40	56.00	B
C	87759-3814	87759-3864	87759-3874	38	--	37.90	36.00	38.20	26.20	52.40	56.00	B
	87759-4014	87759-4064	87759-4074	40	--	39.90	38.00	40.20	26.20	52.40	56.00	B
	87759-4214	87759-4264	87759-4274	42	--	41.90	40.00	42.20	26.20	52.40	56.00	B
	87759-4414	87759-4464	87759-4474	44	--	43.90	42.00	44.20	26.20	52.40	56.00	B
	87759-4614	87759-4664	87759-4674	46	--	45.90	44.00	46.20	26.20	52.40	56.00	B
	87759-4814	87759-4864	87759-4874	48	--	47.90	46.00	48.20	26.20	52.40	56.00	B
B	87759-5014	87759-5064	87759-5074	50	--	49.90	48.00	50.20	34.20	68.40	72.00	B

NOTES:  
 $\triangle A$  VOIDED PIN CKT#10 FOR PART#87759-1002

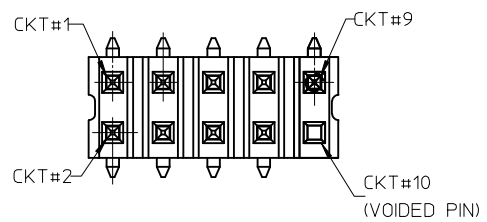

<b>ADD. OPTION</b> EC NO: S2009-0510 DRWN:ATSEE CHKD:SKANG APPR:MLONG 2009/01/23 2009/02/09 2009/02/17	<b>QUALITY SYMBOLS</b> $\nabla=0$ $\triangle C=0$	<b>GENERAL TOLERANCES (UNLESS SPECIFIED)</b> <table border="1"> <tr> <th></th> <th>mm</th> <th>INCH</th> </tr> <tr> <td>4 PLACES</td> <td><math>\pm</math> ---</td> <td><math>\pm</math> ---</td> </tr> <tr> <td>3 PLACES</td> <td><math>\pm</math> ---</td> <td><math>\pm</math> ---</td> </tr> <tr> <td>2 PLACES</td> <td><math>\pm</math> 0.2</td> <td><math>\pm</math> ---</td> </tr> <tr> <td>1 PLACE</td> <td><math>\pm</math> ---</td> <td><math>\pm</math> ---</td> </tr> </table>		mm	INCH	4 PLACES	$\pm$ ---	$\pm$ ---	3 PLACES	$\pm$ ---	$\pm$ ---	2 PLACES	$\pm$ 0.2	$\pm$ ---	1 PLACE	$\pm$ ---	$\pm$ ---	<b>DIMENSION STYLE</b> <b>MM ONLY</b> DRAWN BY: KSEE CHECKED BY: KCLING APPROVED BY: SKTOH DATE: 2003/12/12 DATE: 2004/01/12 DATE: 2004/01/12	<b>SCALE</b> NTS <b>DESIGN UNITS</b> METRIC <b>THIRD ANGLE PROJECTION</b>	<b>TITLE</b> CUSTOM HEADER MGRID, 2MM DUAL ROW HDR. SMT <b>MOLEX INCORPORATED</b> DOCUMENT NO. SD-87759-117	SHEET NO. 6 OF 6
				mm	INCH																
			4 PLACES	$\pm$ ---	$\pm$ ---																
			3 PLACES	$\pm$ ---	$\pm$ ---																
2 PLACES	$\pm$ 0.2	$\pm$ ---																			
1 PLACE	$\pm$ ---	$\pm$ ---																			
<b>DRAFT WHERE APPLICABLE MUST REMAIN WITHIN DIMENSIONS</b>	<b>SEE TABLE</b>	<b>THIS DRAWING CONTAINS INFORMATION THAT IS PROPRIETARY TO MOLEX INCORPORATED AND SHOULD NOT BE USED WITHOUT WRITTEN PERMISSION</b>																			
	<b>SIZE</b> A3	<b>THIS DRAWING CONTAINS INFORMATION THAT IS PROPRIETARY TO MOLEX INCORPORATED AND SHOULD NOT BE USED WITHOUT WRITTEN PERMISSION</b>																			
	<b>REV</b> B2	<b>THIS DRAWING CONTAINS INFORMATION THAT IS PROPRIETARY TO MOLEX INCORPORATED AND SHOULD NOT BE USED WITHOUT WRITTEN PERMISSION</b>																			