

PLEASE CHECK WWW.MOLEX.COM FOR LATEST PART INFORMATION

Part Number: [5031751410](#)
Status: **Active**
Description: 1.50mm (.059") Pitch CLIK-Mate™ Wire-to-Board PCB Receptacle, Single Row, Through Hole, Right Angle, without Peg, 14 Circuits

Documents:

[3D Model](#) [Product Specification PS-503175-001 \(PDF\)](#)
[Drawing \(PDF\)](#) [RoHS Certificate of Compliance \(PDF\)](#)

General

Product Family	PCB Receptacles
Series	503175
Application	Wire-to-Board
Product Name	CLIK-Mate™

Physical

Circuits (Loaded)	14
Color - Resin	Beige
Durability (mating cycles max)	30
Glow-Wire Compliant	No
Guide to Mating Part	Yes
Keying to Mating Part	Yes
Lock to Mating Part	Yes
Material - Metal	Copper Alloy
Material - Plating Mating	Tin
Material - Plating Termination	Tin
Number of Rows	1
Orientation	Right Angle
PCB Locator	No
PCB Retention	Yes
PCB Thickness Recommended (in)	0.062 In
PCB Thickness Recommended (mm)	1.60 mm
Packaging Type	Tray
Pitch - Mating Interface (in)	0.059 In
Pitch - Mating Interface (mm)	1.50 mm
Polarized to Mating Part	Yes
Polarized to PCB	Yes
Stackable	No
Temperature Range - Operating	-25°C to +85°C
Termination Interface: Style	Through Hole

Electrical

Current - Maximum per Contact	2A
Voltage - Maximum	100V

Material Info

Reference - Drawing Numbers

Packaging Specification	SPK-503175-001
Product Specification	PS-503175-001, RPS-503175-001, RPS-503175-002
Sales Drawing	SD-503175-002

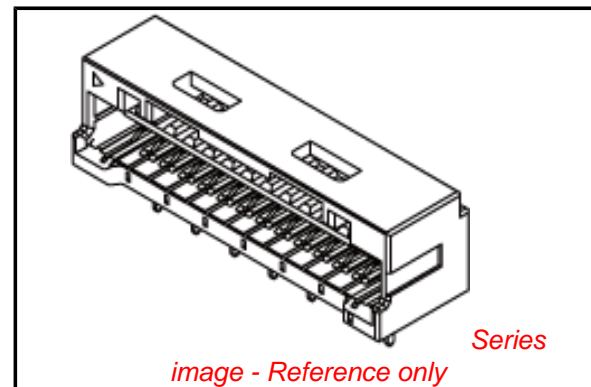

image - Reference only

EU RoHS

**ELV and RoHS
Compliant**
**REACH SVHC
Contains SVHC: No**
**Halogen-Free
Status
Not Reviewed**

China RoHS



**Need more information on product
environmental compliance?**

Email productcompliance@molex.com
For a multiple part number RoHS Certificate of Compliance, [click here](#)

Please visit the [Contact Us](#) section for any non-product compliance questions.

Search Parts in this Series

[503175Series](#)

Mates With

[502578](#) Crimp Housing . [502579](#) Crimp Terminal

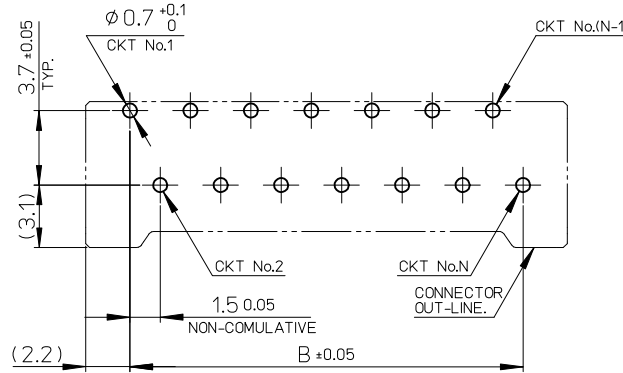
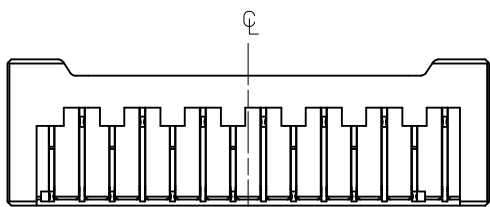
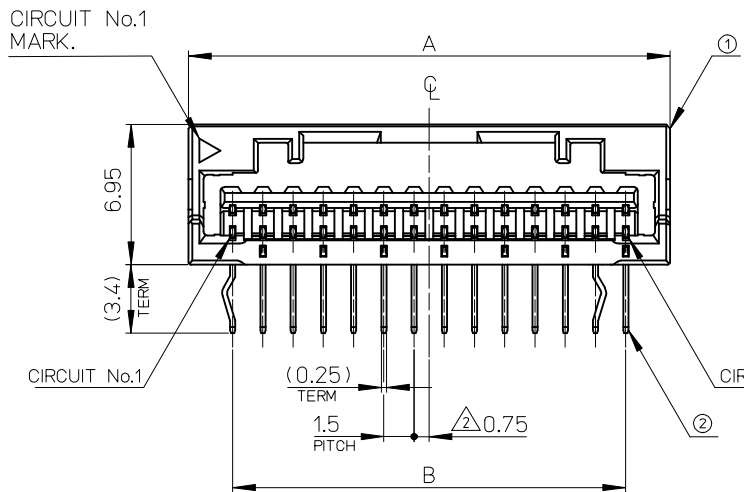
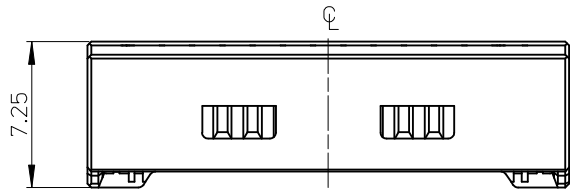

基板取付穴推奨寸法(マウント面)
RECOMMENDED P.C.BOARD
HOLE DIMENSION
(MOUNTING SIDE)
(t=1.6)

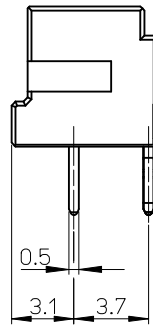

No.	部品 PART	材料 MATERIAL
①	ハウジング HOUSING	ポリアミド(PA) UL94V-0 POLYAMIDE UL94V-0 色: 注記 5. 参照 COLOR: SEE NOTES 5.
②	ターミナル TERMINAL	銅合金 COPPER ALLOY テール部: 錫めっき TAIL AREA: TIN PLATING 下地: ニッケルめっき(1.0μm以上) UNDER PLATING: NICKEL (1.0 MICROMETER MINIMUM)

CIRCUIT No.1
MARK.

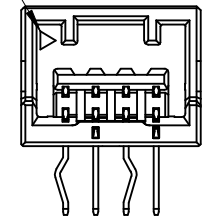

2~11極 CIRCUIT NO.1
CIRCUIT No.1 OF 2-11 CIRCUIT

26.8	21	25.4	503175-151*	15
25.3	19.5	23.9	503175-141*	14
23.8	18	22.4	503175-131*	13
22.3	16.5	20.9	503175-121*	12
20.8	15	19.4	503175-111*	11
19.3	13.5	17.9	503175-101*	10
17.8	12	16.4	503175-091*	9
16.3	10.5	14.9	503175-081*	8
14.8	9	13.4	503175-071*	7
13.3	7.5	11.9	503175-061*	6
11.8	6	10.4	503175-051*	5
10.3	4.5	8.9	503175-041*	4
8.8	3	7.4	503175-031*	3
7.3	1.5	5.9	503175-021*	2
C	B	A	TRAY PACKAGE ORDER No.	CIRCUIT

REVISED EC NO.: J2009-2905 DRWN: TODA 2009/06/25 CHKD: SMARUYAMA 2009/06/25 APPR: SICHIKAWA 2009/06/26	DESCRIPTION	GENERAL TOLERANCES (UNLESS SPECIFIED)		DIMENSION STYLE MM ONLY		SCALE 4:1	DESIGN UNITS METRIC	THIRD ANGLE PROJECTION		
		10 UNDER	± 0.2	DRAWN BY NNISHI	DATE 2008/09/03	TITLE 1.5 W/B SINGLE DIP R/A RECESSY 2-15CKT WITHOUT BOSS				
		10 OVER 30 UNDER	± 0.25	CHECKED BY SMARUYAMA	DATE 2008/09/03	MOLEX INCORPORATED				
		30 OVER	± 0.3	APPROVED BY SICHIKAWA	DATE 2008/09/03					
REV	DESCRIPTION	ANGULAR	± 3 °	MATERIAL NO.	SEE TABLE	DOCUMENT NO. SD-503175-002	SHEET NO. 1 OF 2	THIS DRAWING CONTAINS INFORMATION THAT IS PROPRIETARY TO MOLEX INCORPORATED AND SHOULD NOT BE USED WITHOUT WRITTEN PERMISSION		

△ COLOR VARIATION&ORDER No.

VIOLET	ORANGE	BROWN	GREEN	PINK	BLUE	YELLOW	RED	BLACK	BEIGE	
503175-1519	503175-1518	503175-1517	503175-1516	503175-1515	503175-1514	503175-1513	503175-1512	503175-1511	503175-1510	15
503175-1419	503175-1418	503175-1417	503175-1416	503175-1415	503175-1414	503175-1413	503175-1412	503175-1411	503175-1410	14
503175-1319	503175-1318	503175-1317	503175-1316	503175-1315	503175-1314	503175-1313	503175-1312	503175-1311	503175-1310	13
503175-1219	503175-1218	503175-1217	503175-1216	503175-1215	503175-1214	503175-1213	503175-1212	503175-1211	503175-1210	12
503175-1119	503175-1118	503175-1117	503175-1116	503175-1115	503175-1114	503175-1113	503175-1112	503175-1111	503175-1110	11
503175-1019	503175-1018	503175-1017	503175-1016	503175-1015	503175-1014	503175-1013	503175-1012	503175-1011	503175-1010	10
503175-0919	503175-0918	503175-0917	503175-0916	503175-0915	503175-0914	503175-0913	503175-0912	503175-0911	503175-0910	9
503175-0819	503175-0818	503175-0817	503175-0816	503175-0815	503175-0814	503175-0813	503175-0812	503175-0811	503175-0810	8
503175-0719	503175-0718	503175-0717	503175-0716	503175-0715	503175-0714	503175-0713	503175-0712	503175-0711	503175-0710	7
503175-0619	503175-0618	503175-0617	503175-0616	503175-0615	503175-0614	503175-0613	503175-0612	503175-0611	503175-0610	6
503175-0519	503175-0518	503175-0517	503175-0516	503175-0515	503175-0514	503175-0513	503175-0512	503175-0511	503175-0510	5
503175-0419	503175-0418	503175-0417	503175-0416	503175-0415	503175-0414	503175-0413	503175-0412	503175-0411	503175-0410	4
503175-0319	503175-0318	503175-0317	503175-0316	503175-0315	503175-0314	503175-0313	503175-0312	503175-0311	503175-0310	3
503175-0219	503175-0218	503175-0217	503175-0216	503175-0215	503175-0214	503175-0213	503175-0212	503175-0211	503175-0210	2
TRAY PACKAGE ORDER NO.	TRAY PACKAGE ORDER NO.	TRAY PACKAGE ORDER NO.	TRAY PACKAGE ORDER NO.	TRAY PACKAGE ORDER NO.	TRAY PACKAGE ORDER NO.	TRAY PACKAGE ORDER NO.	TRAY PACKAGE ORDER NO.	TRAY PACKAGE ORDER NO.	TRAY PACKAGE ORDER NO.	CIRCUIT

NOTES

1. 嵌合相手：502578シリーズ
MATE WITH：502578 SERIES.
2. 極数=偶数に適用
APPLY FOR CIRCUIT SIZE/2=EVEN.
3. 端子テール部に錫めっきを使用している為、外観に摺動痕が付く場合があります。
THE WOUND OF FRICTION MIGHT ADHERE TO EXTERNALS BECAUSE THE TIN PLATING IS USED FOR THE TAIL.

4. 製品番号
MATERIAL No.

503175- $\times \times 1 \times$



ボス無し WITHOUT BOSS.

CIRCUIT	WITHOUT BOSS No.	COLOR No.	COLOR
02~15	1	0	ベージュ BEIGE
		1	黒 BLACK
		2	赤 RED
		3	黄 YELLOW
		4	青 BLUE
		5	桃 PINK
		6	緑 GREEN
		7	茶 BROWN
		8	橙 ORANGE
9	紫 VIOLET		

5. 本製品のプラスチック部に黒点・白点等が確認される場合や色合いが異なる場合がありますが、製品性能に影響はありません。
THERE IS NO INFLUENCE IN THE PRODUCT PERFORMANCE THOUGH THE BLACK AND WHITE SPOT ETC. MIGHT BE CONFIRMED TO THE PLASTIC PART OF THIS PRODUCT AND THE SHADE MIGHT BE DIFFERENT.
6. ELV及びRoHS適合品
ELV AND RoHS COMPLIANT
7. ボス有形状は“SD-503159-001”を参照願います。
REFER TO “SD-503159-001” FOR WITH BOSS.

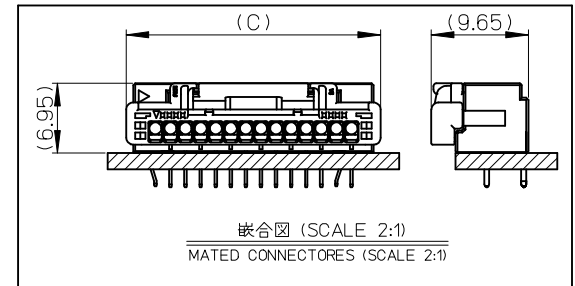
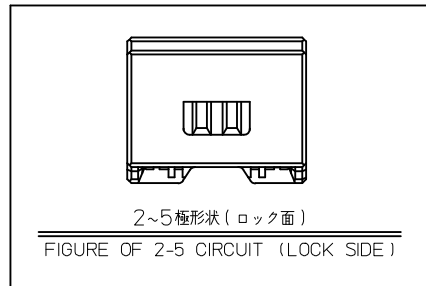

REVISED EC NO. J2009-2905 DRWN: TODA 2009/06/25 CHKD: SMARUYAMA 2009/06/25 APPR: SICHIKAWA 2009/06/26	GENERAL TOLERANCES (UNLESS SPECIFIED)		DIMENSION STYLE MM ONLY	SCALE ---	DESIGN UNITS METRIC	THIRD ANGLE PROJECTION
	10 UNDER	±0.2	DRAWN BY NNISHI	DATE 2008/09/03	TITLE 1.5 W/B SINGLE DIP R/A REC.ASSY 2-15CKT WITHOUT BOSS	
	10 OVER 30 UNDER	±0.25	CHECKED BY SMARUYAMA	DATE 2008/09/03	MOLEX INCORPORATED	
	30 OVER	±0.3	APPROVED BY SICHIKAWA	DATE 2008/09/03	DOCUMENT NO. SD-503175-002	SHEET NO. 2 OF 2
D	REV	ANGULAR ±3° DRAFT WHERE APPLICABLE MUST REMAIN WITHIN DIMENSIONS	SEE TABLE	THIS DRAWING CONTAINS INFORMATION THAT IS PROPRIETARY TO MOLEX INCORPORATED AND SHOULD NOT BE USED WITHOUT WRITTEN PERMISSION		