

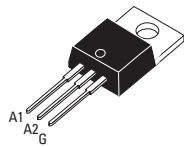

**Applications**

- Phase Control
- Static Switching
- Light Dimming
- Motor Speed Control
- Kitchen Equipment
- Power Tools
- Solenoid Valve Controls:
  - Dishwashers
  - Washing Machines

- Suitable for General Purpose AC Switching
- Alternistor/No Snubber Versions for Inductive Loads
- Logic Level Available for Use with Microcontrollers and Low Level Devices
- IGT Range 10-50 mA (Q1)
- $V_{DRM}/V_{RMM}$  400, 600, 800, 1000V



TO-220AB Isolated (CTA16)

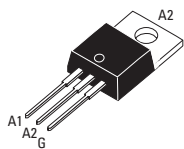

TO-220AB Non-Isolated (CTB16)



**Absolute Maximum Ratings**

	CONDITIONS	SYMBOL	RATING
RMS On-State Current (full sine wave)	$T_c = 100^\circ\text{C}$ $T_c = 85^\circ\text{C}$	TO-220AB TO-220AB Iso $I_{T(RMS)}$	16A
Non Repetitive Surge Peak On-State Current (Full Cycle, $T_j$ Initial = $25^\circ\text{C}$ )	F = 50 Hz F = 60 Hz	$I_{TSM}$	160A 168A
$I^2t$ Value for fusing	$t_p = 10$ ms	$I^2t$	144A <sup>2</sup> s
Critical rate of rise of on-state current $I_G = 2 \times I_{GT}$ , $t_r < 100$ ns, $T_j = 125^\circ\text{C}$	F = 120 Hz	di/dt	100A/ $\mu$ s
Peak Gate Current @ $T_j = 125^\circ\text{C}$	$t_p = 20$ $\mu$ s	$I_{GM}$	4A
Average Gate Power Dissipation @ $T_j = 125^\circ\text{C}$		$P_{G(AV)}$	1W
Storage Temperature Range		$T_{stg}$	-40 to +150°C
Operating Junction Temperature Range		$T_j$	-40 to +125°C
Isolation Voltage (CTA Series only)		$V_{ISO}$	2500 $V_{RMS}$

**Electrical Characteristics**

ALTERNISTOR/NO SNUBBER AND LOGIC LEVEL (3 Quadrants)		SW	CW	BW
$I_{GT}$ MAX @ $V_D = 12$ V, $R_L = 30\Omega$ NOTE 1	QI-II-III	10mA	35mA	50mA
$V_{GT}$ MAX @ $V_D = 12$ V, $R_L = 30\Omega$	QI-II-III	1.3V	1.3V	1.3V
$V_{GD}$ MIN @ $V_D = V_{DRM}$ , $R_L = 3.3k\Omega$	$T_j = 125^\circ\text{C}$ QI-II-III	0.2V	0.2V	0.2V
$I_H$ MAX @ $I_T = 500$ mA NOTE 2		15mA	35mA	50mA
$I_L$ MAX @ $I_G = 1.2 I_{GT}$	QI-III	25mA	50mA	70mA
$I_L$ MAX @ $I_G = 1.2 I_{GT}$	Q-II	30mA	60mA	80mA
dv/dt MIN @ $V_D = 67\%V_{DRM}$ (gate open) NOTE 2	$T_j = 125^\circ\text{C}$	40V/ $\mu$ s	500V/ $\mu$ s	1000V/ $\mu$ s
(di/dt)c MIN @ (dv/dt)c = 0.1 V/ms NOTE 2	$T_j = 125^\circ\text{C}$	8.5A/ms		
(di/dt)c MIN @ (dv/dt)c = 10 V/ms NOTE 2	$T_j = 125^\circ\text{C}$	3.0A/ms		
(di/dt)c MIN without Snubber NOTE 2 & 4	$T_j = 125^\circ\text{C}$		8.5A/ms	14A/ms
STANDARD (4 Quadrants)		C	B	
$I_{GT}$ MAX @ $V_D = 12$ V, $R_L = 30\Omega$ NOTE 1	QI-II-III	25mA	50mA	
$I_{GT}$ MAX @ $V_D = 12$ V, $R_L = 30\Omega$ NOTE 1	QIV	50mA	100mA	
$V_{GT}$ MAX @ $V_D = 12$ V, $R_L = 30\Omega$	Q-All	1.3V		
$V_{GD}$ MIN @ $V_D = V_{DRM}$ , $R_L = 3.3k\Omega$	$T_j = 125^\circ\text{C}$ Q-All	0.2V		
$I_H$ MAX @ $I_T = 500$ mA NOTE 2		25mA	50mA	
$I_L$ MAX @ $I_G = 1.2 I_{GT}$	QI-III-IV	40mA	50mA	
$I_L$ MAX @ $I_G = 1.2 I_{GT}$	Q-II	80mA	100mA	
dv/dt MIN @ $V_D = 67\%V_{DRM}$ (gate open) NOTE 2	$T_j = 125^\circ\text{C}$	200V/ $\mu$ s	400V/ $\mu$ s	
(dv/dt)c MIN @ (di/dt)c = 7.0 A/ms NOTE 2	$T_j = 125^\circ\text{C}$	5V/ $\mu$ s	10V/ $\mu$ s	

**GENERAL NOTES**

1. Minimum IGT is guaranteed at 5% of IGT max.
2. For both polarities of A2 referenced to A1
3. All parameters at 25 degrees C unless otherwise specified.
4. Commutating dv/dt=50V/ $\mu$ sec (exponential to 200Vpk)

## Static Characteristics

$V_T$ MAX @ $I_{TM} = 22.5$ A, $t_p = 380\mu s$ NOTE 2	$T_j = 25^\circ C$	1.55V
$V_{TO}$ MAX @ Threshold Voltage NOTE 2	$T_j = 125^\circ C$	0.85V
$R_d$ MAX @ Dynamic Resistance NOTE 2	$T_j = 125^\circ C$	25m $\Omega$
$I_{DRM}$ MAX @ $V_{DRM} = V_{RRM}$	$T_j = 25^\circ C$	5 $\mu A$
$I_{RRM}$ MAX @ $V_{DRM} = V_{RRM}$	$T_j = 125^\circ C$	2mA

## Thermal Resistances

	SYMBOL	RATING
Junction to Case (AC)	T0-220AB	$R_{th(j-c)}$ 1.2°C/W
Junction to Case (AC)	T0-220AB Isolated	$R_{th(j-c)}$ 2.1°C/W
Junction to Ambient	T0-220AB	$R_{th(j-a)}$ 60°C/W
Junction to Ambient	T0-220AB Isolated	$R_{th(j-a)}$ 60°C/W

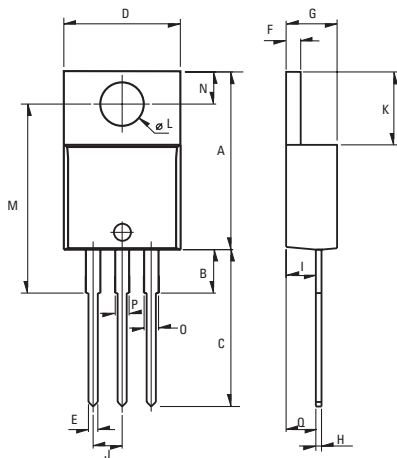

Weight: 2.3g (0.08 oz)

## Dimensions

REF.	Millimeters			Inches		
	Min.	Typ.	Max.	Min.	Typ.	Max.
A	15.24		15.75	0.6		0.62
B		3.23			0.127	
C	12.78		13.79	0.503		0.543
D	9.96		10.36	0.392		0.408
E	0.69		0.94	0.027		0.037
F	1.22		1.32	0.048		0.052
G	4.62		4.83	0.182		0.19
H	0.46		0.61	0.018		0.024
I	2.49		2.84	0.098		0.112
J	2.39		2.69	0.094		0.106
K	6.48		6.88	0.255		0.271
L	3.78		3.89	0.149		0.153
M	15.49	16	16.51	0.61	0.63	0.65
N	2.59		2.9	0.102		0.114
O	0.99		1.55	0.039		0.061
P	0.99		1.55	0.039		0.061
Q		2.67			0.105	

## Part Number Selection

Part Number	Voltage [Vpk]	$I_{GT}$ [mA]	Type	Package
CTA/CTB16-xxxB	400, 600, 800, 1000	50mA	Standard	T0-220AB
CTA/CTB16-xxxBW	400, 600, 800, 1000	50mA	Alternistor/No Snubber	T0-220AB
CTA/CTB16-xxxC	400, 600, 800, 1000	25mA	Standard	T0-220AB
CTA/CTB16-xxxCW	400, 600, 800, 1000	35mA	Alternistor/No Snubber	T0-220AB
CTA/CTB16-xxxSW	400, 600, 800, 1000	10mA	Logic Level	T0-220AB

## Part Number Designation

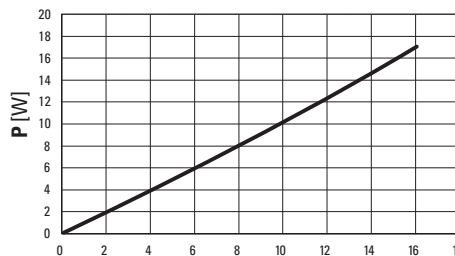
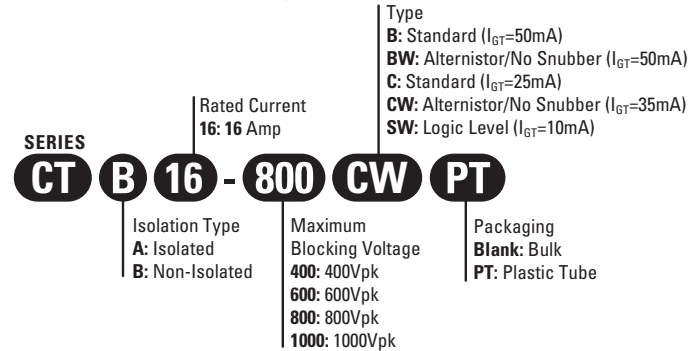

Fig. 1: Power dissipation versus RMS on-state current (full cycle).

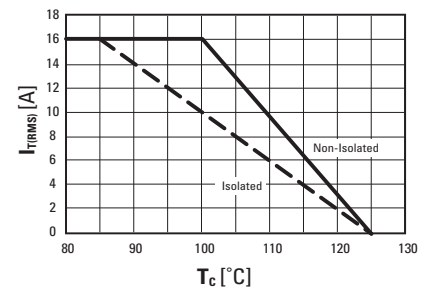

Fig. 2: RMS on-state current versus case temperature (full cycle)

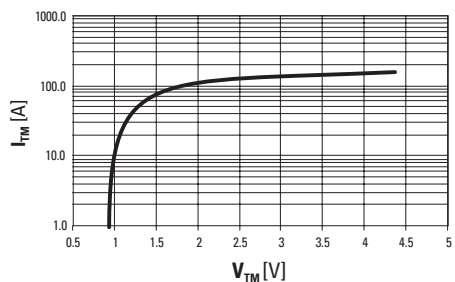

Fig. 3: On-state current versus on-state voltage (instantaneous values)

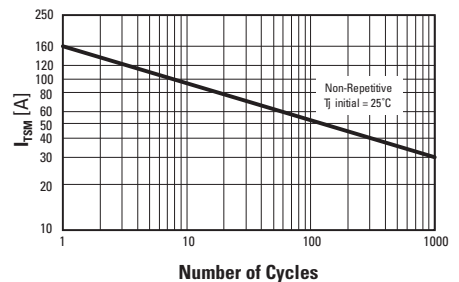

Fig. 4: Non-repetitive surge peak on-state current versus number of cycles.

ISO9001 CERTIFIED

## Approvals

UL Recognized Component - E72445 (CTA Series)

### USA

Sales & Tech Support (866) 258-5057  
 Email: sales@cynergy3.com  
 Cynergy3 Components  
 2320 Paseo de las Americas, Suite 104  
 San Diego, CA 92154

### EUROPE - UK

Telephone +44 (0) 1202 897969  
 Fax +44 (0) 1202 891918  
 Email: sales@cynergy3.com  
 Cynergy3 Components Ltd.  
 7 Cobham Road  
 Ferndown Industrial Estate  
 Wimborne, Dorset BH21 7PE

### ASIA - Thailand

Telephone +66 (0)2 665 2517  
 Fax +66 (0)2 665 2588  
 Cynergy 3 Components, Asia  
 18/8 Fico Place 12th Floor  
 Soi Sukhumvit 21 (Asoke)  
 Klongtoey Nua, Wattana  
 Bangkok, Thailand 10110