



## MIC37150/51/52/53

### 1.5A, Low Voltage $\mu$ Cap LDO Regulator

#### General Description

The Micrel MIC37150/51/52/53 is a 1.5A low-dropout linear voltage regulator that provides a low voltage, high current output with a minimum of external components. It offers high precision, ultra-low dropout (500mV over temperature), and low ground current.

The MIC37150/51/52/53 operates from an input of 2.25V to 6.0V. It is designed to drive digital circuits requiring low voltage at high currents (i.e., PLDs, DSPs, micro-controllers, etc.). It is available in fixed and adjustable output voltages. Fixed voltages include 1.5V, 1.65V, 1.8V, 2.5V and 3.3V. The adjustable version is capable of supplying output voltages from 1.24V to 5.5V.

Features of the MIC37150/51/52/53 LDO include thermal and current limit protection, and reverse current and reverse battery protection. Logic enable and error flag pins are available.

Junction temperature range of the MIC37150/51/52/53 is from  $-40^{\circ}\text{C}$  to  $+125^{\circ}\text{C}$ .

For applications requiring input voltage greater than 6.0V, see MIC3910x, MIC3915x, MIC3930x, and MIC3950x LDOs.

Data sheets and support documentation can be found on Micrel's web site at [www.micrel.com](http://www.micrel.com).

#### Features

- 1.5A minimum guaranteed output current
- 500mV maximum dropout voltage over temperature
  - **Ideal for 3.0V to 2.5V conversion**
  - **Ideal for 2.5V to 1.8V, 1.65V, or 1.5V conversion**
- Stable with ceramic or tantalum capacitor
- Wide input voltage range
  - VIN: 2.25V to 6.0V
- $\pm 1.0\%$  initial output tolerance
- Fixed and adjustable output voltages
  - MIC37150—3-pin fixed voltages
  - MIC37151—5-pin S-Pak or 8-pin e-Pad SOIC fixed voltages with flag
  - MIC37152—5-pin adjustable voltage
  - MIC37153—8-pin adjustable voltage with flag
- Excellent line and load regulation specifications
- Logic controlled shutdown
- Thermal shutdown and current limit protection
- Reverse-leakage protection
- Low profile 3 or 5-pin S-Pak packages or 8-pin e-Pad SOIC

#### Applications

- LDO linear regulator for low-voltage digital IC
- PC add-in cards
- High efficiency linear power supplies
- SMPS post regulator
- Battery charger

#### Typical Application

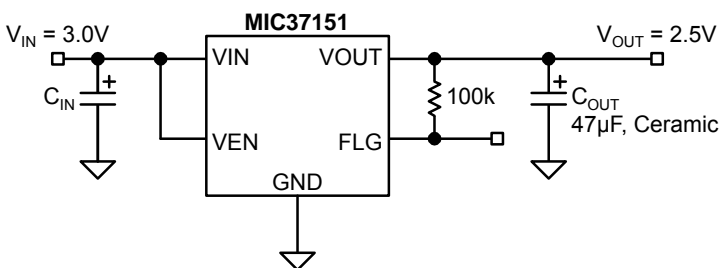

Fixed 2.5V Regulator with Error Flag

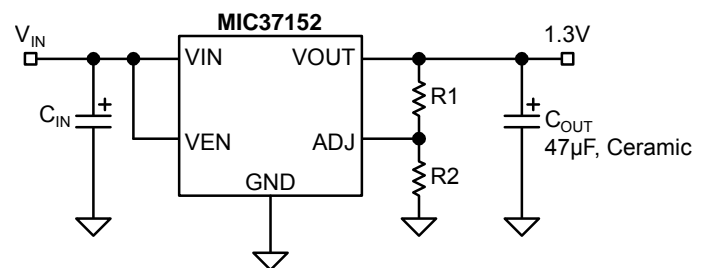

Adjustable Regulator

Super  $\beta$  PNP is a trademark of Micrel, Inc.

Micrel Inc. • 2180 Fortune Drive • San Jose, CA 95131 • USA • tel +1 (408) 944-0800 • fax +1 (408) 474-1000 • <http://www.micrel.com>

October 2007

M9999-101907

## Ordering Information

| Part Number     |                           | Output Current | Voltage | Junction Temp. Range | Package       |
|-----------------|---------------------------|----------------|---------|----------------------|---------------|
| Standard        | RoHS Compliant* / Pb-free |                |         |                      |               |
| MIC37150-1.5BR  | MIC37150-1.5WR*           | 1.5A           | 1.5V    | -40° to +125°C       | S-PAK-3       |
| MIC37150-1.65BR | MIC37150-1.65WR*          | 1.5A           | 1.65V   | -40° to +125°C       | S-PAK-3       |
| MIC37150-1.8BR  | MIC37150-1.8WR*           | 1.5A           | 1.8V    | -40° to +125°C       | S-PAK-3       |
| MIC37150-2.5BR  | MIC37150-2.5WR*           | 1.5A           | 2.5V    | -40° to +125°C       | S-PAK-3       |
| MIC37150-3.3BR  | MIC37150-3.3WR*           | 1.5A           | 3.3V    | -40° to +125°C       | S-PAK-3       |
| MIC37151-1.5BR  | MIC37151-1.5WR*           | 1.5A           | 1.5V    | -40° to +125°C       | S-PAK-5       |
|                 | MIC37151-1.5YME*          | 1.5A           | 1.5V    | -40° to +125°C       | e-Pad SOIC-8  |
| MIC37151-1.65BR | MIC37151-1.65WR*          | 1.5A           | 1.65V   | -40° to +125°C       | S-PAK-5       |
|                 | MIC37151-1.8YME*          | 1.5A           | 1.8V    | -40° to +125°C       | e- Pad SOIC-8 |
| MIC37151-1.8BR  | MIC37151-1.8WR*           | 1.5A           | 1.8V    | -40° to +125°C       | S-PAK-5       |
|                 | MIC37151-2.5YME**         | 1.5A           | 2.5V    | -40° to +125°C       | e-Pad SOIC-8  |
| MIC37151-2.5BR  | MIC37151-2.5WR*           | 1.5A           | 2.5V    | -40° to +125°C       | S-PAK-5       |
| MIC37151-3.3BR  | MIC37151-3.3WR*           | 1.5A           | 3.3V    | -40° to +125°C       | S-PAK-5       |
| MIC37152BR      | MIC37152WR*               | 1.5A           | ADJ     | -40° to +125°C       | S-PAK-5       |
|                 | MIC37152YM                | 1.5A           | ADJ     | -40° to +125°C       | SOIC-8        |
|                 | MIC37153YME**             | 1.5A           | ADJ     | -40° to +125°C       | e-Pad SOIC-8  |

\* RoHS compliant with 'high-melting solder' exemption.

\*\* Contact factory for availability.

## Pin Configuration

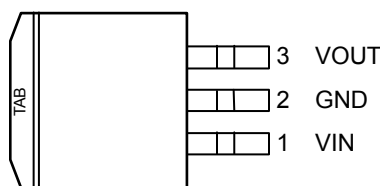

**S-PAK-3 (R)**

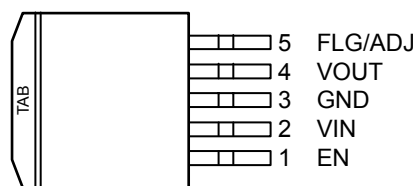

**S-PAK-5 (R)**

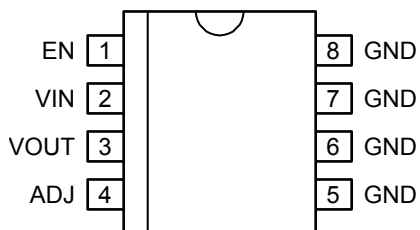

**SOIC-8 (M)**

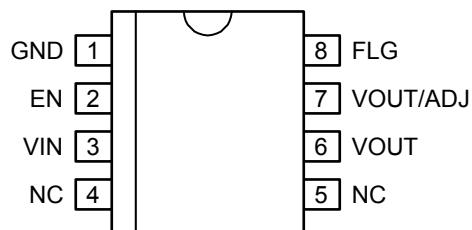

**e-Pad SOIC-8 (ME)**

## Pin Description

| Pin Number<br>S-PAK-3 | Pin Number<br>S-PAK-5 | Pin Number<br>SOIC-8 | Pin Number<br>e-Pad SOIC-8 | Pin Name | Pin Name  |
|-----------------------|-----------------------|----------------------|----------------------------|----------|---|
| –                     | 1                     | 1                    | 2                          | EN       | Enable (Input): CMOS compatible input. Logic high = enable, logic low = shutdown.           |
| 1                     | 2                     | 2                    | 3                          | VIN      | Input voltage which supplies current to the output power device.                            |
| 2                     | 3                     | 5, 6, 7, 8           | 1                          | GND      | Ground (TAB is connected to ground on S-Pak)  |
| 3                     | 4                     | 3                    | 6, 7 (Fixed)               | VOUT     | Regulator Output  |
|                       |                       |                      | 6 (Adj)                    |          |   |
| –                     | 5                     | –                    | 8                          | FLG      | Error Flag (Output): Open collector output. Active low indicates an output fault condition. |
| –                     |                       | 4                    | 7                          | ADJ      | Adjustable regulator feedback input. Connect to resistor voltage divider.                   |
| –                     | –                     | –                    | 4, 5                       | NC       | Not internally connected.   |

### Absolute Maximum Ratings<sup>(1)</sup>

|  |  |
|--|--|
| Supply Voltage ( $V_{IN}$ ).....         | 6.5V   |
| Enable Input Voltage ( $V_{EN}$ ).....   | 6.5V   |
| Power Dissipation .....                  | Internally Limited                                       |
| Junction Temperature .....               | $-40^{\circ}\text{C} \leq T_J \leq +125^{\circ}\text{C}$ |
| Storage Temperature ( $T_S$ ) .....      | $-65^{\circ}\text{C} \leq T_J \leq +150^{\circ}\text{C}$ |
| Lead Temperature (soldering, 5sec.)..... | 260°C  |
| EDS Rating.....                          | <b>Note 3</b>  |

### Operating Ratings<sup>(2)</sup>

|  |  |
|--|--|
| Supply voltage ( $V_{IN}$ ) .....      | 2.25V to 6.0V  |
| Enable Input Voltage ( $V_{EN}$ )..... | 0V to 6.0V   |
| Junction Temperature Range .....       | $-40^{\circ}\text{C} \leq T_J \leq +125^{\circ}\text{C}$ |
| Maximum Power Dissipation.....         | <b>Note 4</b>  |
| Package Thermal Resistance             |  |
| S-Pak ( $\theta_{JC}$ ) .....          | 2°C/W  |
| Power SOIC-8 ( $\theta_{JA}$ ) .....   | 63°C/W   |
| e-Pad SOIC-8 ( $\theta_{JC}$ ).....    | 10°C/W   |

### Electrical Characteristics<sup>(5)</sup>

$T_A = 25^{\circ}\text{C}$  with  $V_{IN} = V_{OUT} + 1\text{V}$ ;  $V_{EN} = V_{IN}$ ; **bold** values indicate  $-40^{\circ}\text{C} < T_J < +125^{\circ}\text{C}$ , unless otherwise noted.

| Parameter  | Condition   | Min          | Typ       | Max               | Units                          |
|--|---|--------------|-----------|-------------------|--------------------------------|
| Output Voltage Accuracy                                | $I_L = 10\text{mA}$   | -1           |           | +1                | %                              |
|  | $10\text{mA} < I_{OUT} < I_{L(max)}$ , $V_{OUT} + 1 \leq V_{IN} \leq 6\text{V}$ | <b>-2</b>    |           | <b>+2</b>         | %                              |
| Output Voltage Line Regulation                         | $V_{IN} = V_{OUT} + 1.0\text{V}$ to 6.0V  |              | 0.06      | 0.5               | %                              |
| Output Voltage Load Regulation                         | $I_L = 10\text{mA}$ to 1.5A   |              | 0.2       | 1                 | %                              |
| $V_{IN} - V_{OUT}$ ; Dropout Voltage,<br><b>Note 6</b> | $I_L = 750\text{mA}$  |              |           | <b>350</b>        | mV                             |
|  | $I_L = 1.5\text{A}$   |              |           | <b>500</b>        | mV                             |
| Ground Pin Current, <b>Note 7</b>                      | $I_L = 1.5\text{A}$   |              | 17        | <b>30</b>         | mA                             |
| Ground Pin Current in Shutdown                         | $V_{IL} \leq 0.5\text{V}$ , $V_{IN} = V_{OUT} + 1\text{V}$                      |              | 1.0       |                   | $\mu\text{A}$                  |
| Current Limit  | $V_{OUT} = 0$   |              | 2.25      | <b>4.0</b>        | A                              |
| Start-up Time  | $V_{EN} = V_{IN}$ , $I_{OUT} = 10\text{mA}$ , $C_{OUT} = 22\mu\text{F}$         |              | 170       | <b>500</b>        | $\mu\text{s}$                  |
| <b>Enable Input</b>                                    |   |              |           |                   |                                |
| Enable Input Threshold                                 | Regulator enable  | <b>2.25</b>  |           |                   | V                              |
|  | Regulator shutdown  |              |           | <b>0.8</b>        | V                              |
| Enable Pin Input Current                               | $V_{IL} \leq 0.8\text{V}$ (regulator shutdown)                                  |              |           | 2<br><b>4</b>     | $\mu\text{A}$<br>$\mu\text{A}$ |
|  | $V_{IH} \geq 2.25\text{V}$ (regulator enabled)                                  | 1            | 15        | 30<br><b>75</b>   | $\mu\text{A}$<br>$\mu\text{A}$ |
| <b>Flag Output</b>                                     |   |              |           |                   |                                |
| $I_{FLG(LEAK)}$  | $V_{OH} = 6\text{V}$  |              |           | 1<br><b>2</b>     | $\mu\text{A}$<br>$\mu\text{A}$ |
|  |   |              |           |                   |                                |
| $V_{FLG(LO)}$  | $V_{IN} = 2.25\text{V}$ , $I_{OL} = 250\mu\text{A}$ , <b>Note 8</b>             |              | 210       | 300<br><b>400</b> | mV<br>mV                       |
| $V_{FLG}$  | Low threshold, % of $V_{OUT}$ below nominal                                     | 93           |           |                   | %                              |
|  | Hysteresis  |              | 2         |                   | %                              |
|  | High threshold, % of $V_{OUT}$ below nominal                                    |              |           | 99.2              | %                              |
| Reference Voltage                                      |   | 1.228        | 1.240     | 1.252             | V                              |
|  | <b>Note 9</b>   | <b>1.215</b> |           | <b>1.265</b>      | V                              |
| Reference Voltage Temp. Coefficient                    | <b>Note 10</b>  |              | <b>20</b> |                   | ppm/ $^{\circ}\text{C}$        |
| Adjust Pin Bias Current                                |   |              | 40        | 80<br><b>120</b>  | nA<br>nA                       |
|  |   |              | 0.1       |                   | nA/ $^{\circ}\text{C}$         |

**Notes:**

1. Exceeding the absolute maximum rating may damage the device.
2. The device is not guaranteed to function outside its operating rating.
3. Devices are ESD sensitive. Handling precautions recommended.
4.  $P_{D(MAX)} = (T_{J(MAX)} - T_A) / \theta_{JA}$ , where  $\theta_{JA}$ , depends upon the printed circuit layout. See "Applications Information."
5. Specification for packaged product only.
6.  $V_{DO} = V_{IN} - V_{OUT}$  when  $V_{OUT}$  decreased to 98% of its nominal output voltage with  $V_{IN} = V_{OUT} + 1V$ . For output voltages below 1.75V, dropout voltage specification does not apply due to a minimum input operating voltage of 2.25V.
7.  $I_{IN}$  is the quiescent current.  $I_{IN} = I_{IN} + I_{OUT}$ .
8. For a 2.5V device,  $V_{IN} = 2.250V$  (device is in dropout).
9.  $V_{REF} \leq V_{OUT} \leq (V_{IN} - 1.0V)$ ,  $2.25V \leq V_{IN} \leq 6.0V$ ,  $10mA \leq I_L \leq 1.5A$ ,  $T_J = T_{MAX}$ .
10. Thermal regulation is defined as the change in output voltage at a time  $t$  after a change in power dissipation is applied, excluding load or line regulation effects. Specifications are for a 200mA load pulse at  $V_{IN} = 6V$  for  $t = 10ms$ .

# Typical Characteristics

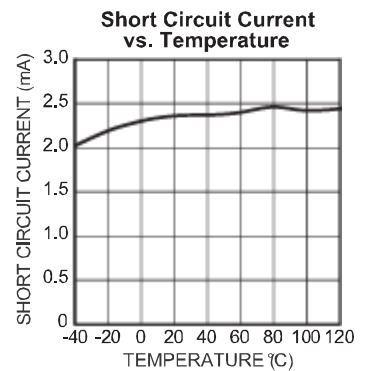
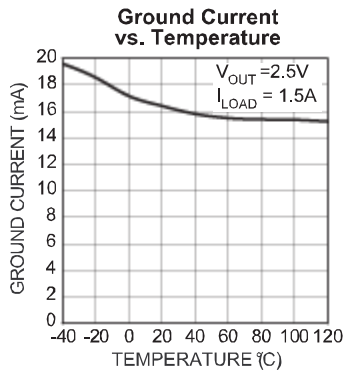
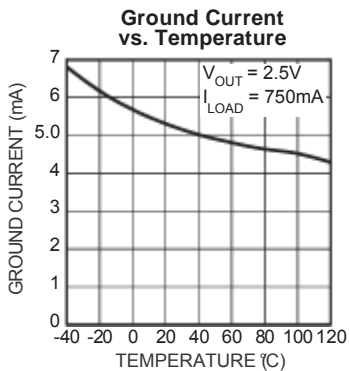
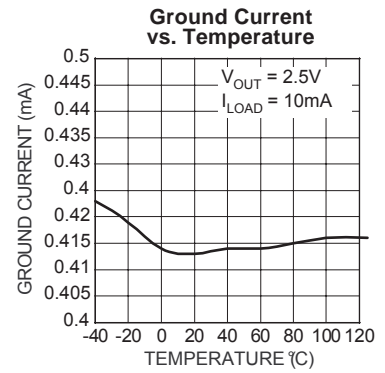
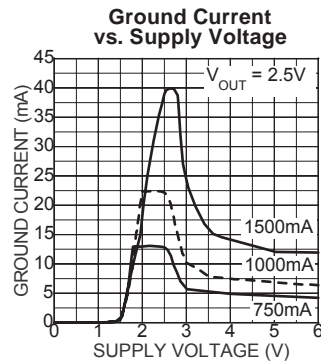
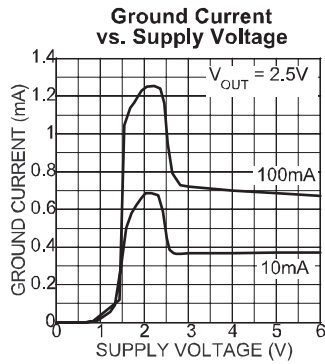
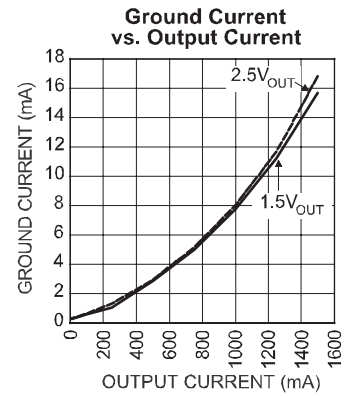
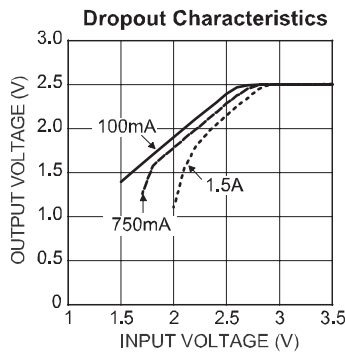
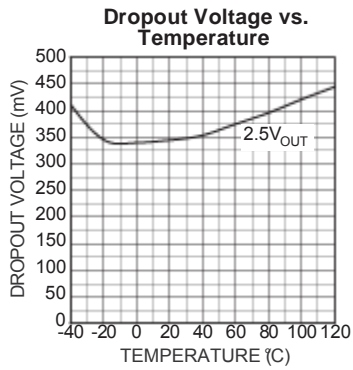
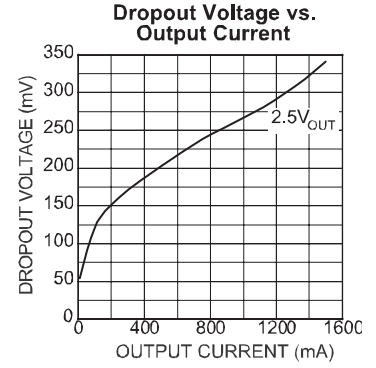
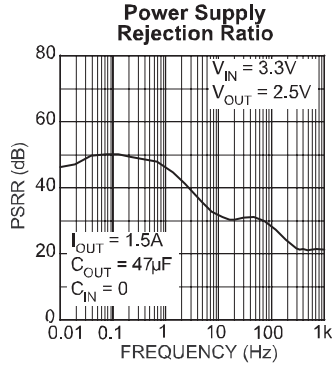
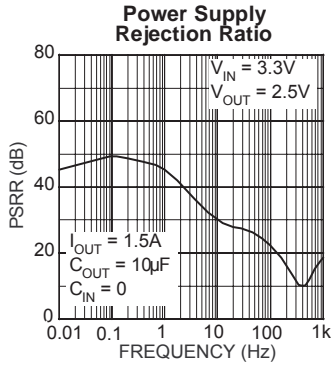

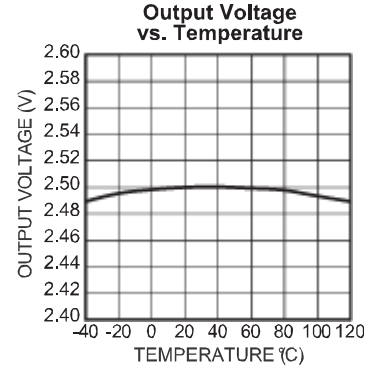
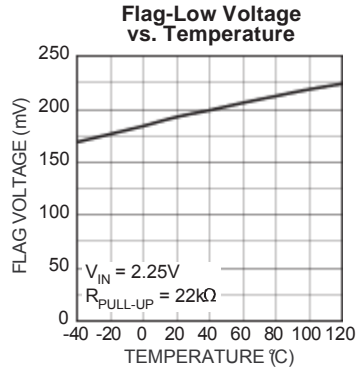
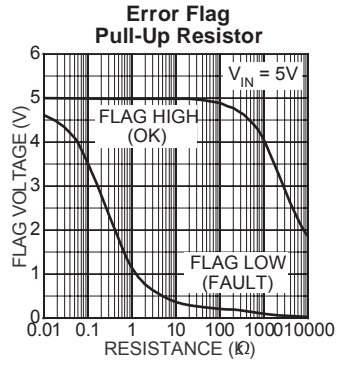

## Functional Characteristics

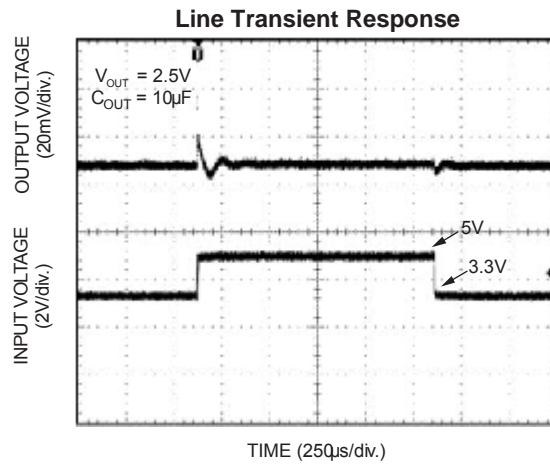
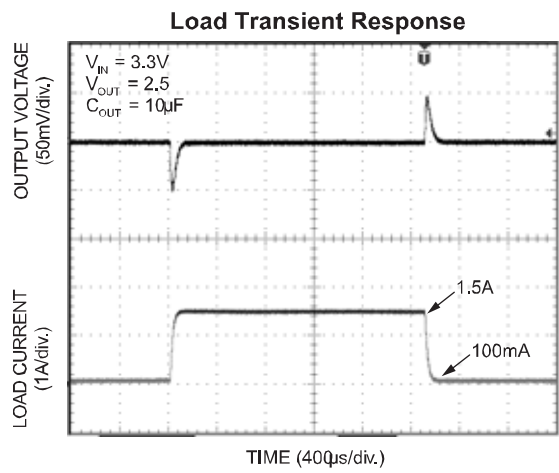
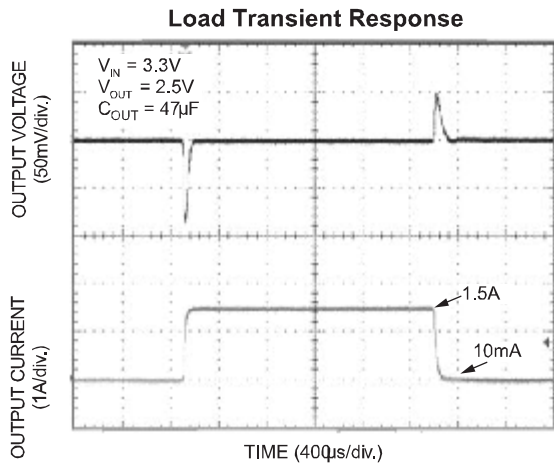



## Application Information

The MIC37150/51/52/53 is a high-performance low-dropout voltage regulator suitable for moderate to high-current regulator applications. Its 500mV dropout voltage at full load and over-temperature makes it especially valuable in battery-powered systems and as high-efficiency noise filters in post-regulator applications. Unlike older NPN-pass transistor designs, there the minimum dropout voltage is limited by the based-to-emitter voltage drop and collector-to-emitter saturation voltage, dropout performance of the PNP output of these devices is limited only by the low  $V_{CE}$  saturation voltage.

A trade-off for the low dropout voltage is a varying base drive requirement. Micrel's Super Beta PNP™ process reduces this drive requirement to only 2% to 5% of the load current.

The MIC37150/51/52/53 regulator is fully protected from damage due to fault conditions. Current limiting is provided. This limiting is linear; output current during overload conditions is constant. Thermal shutdown disables the device when the die temperature exceeds the maximum safe operating temperature. Transient protection allows device (and load) survival even when the input voltage spikes above and below nominal. The output structure of these regulators allows voltages in excess of the desired output voltage to be applied without reverse current flow.

### Thermal Design

Linear regulators are simple to use. The most complicated design parameters to consider are thermal characteristics. Thermal design requires the following application-specific parameters:

- Maximum ambient temperature ( $T_A$ )
- Output current ( $I_{OUT}$ )
- Output voltage ( $V_{OUT}$ )
- Input voltage ( $V_{IN}$ )
- Ground current ( $I_{GND}$ )

First, calculate the power dissipation of the regulator from these numbers and the device parameters from this datasheet.

$$P_D = (V_{IN} - V_{OUT}) I_{OUT} + V_{IN} I_{GND}$$

Where the ground current is approximated by using numbers from the "Electrical Characteristics" or "Typical Characteristics." Then, the heat sink thermal resistance is determined with this formula:

$$\theta_{SA} = ((T_{J(MAX)} - T_A) / P_D) - (\theta_{JC} + \theta_{CS})$$

Where  $T_{J(MAX)} \leq 125^\circ\text{C}$  and  $\theta_{CS}$  is between  $0^\circ\text{C}$  and  $2^\circ\text{C/W}$ . The heat sink may be significantly reduced in applications where the minimum input voltage is known and is large compared with the dropout voltage. Use a series input resistor to drop excessive voltage and distribute the heat between this resistor and the regulator. The low dropout properties of Micrel Super

Beta PNP™ regulators allow significant reductions in regulator power dissipation and the associated heat sink without compromising performance. When this technique is employed, a capacitor of at least  $1.0\mu\text{F}$  is needed directly between the input and regulator ground.

Refer to "Application Note 9" for further details and examples on thermal design and heat sink applications.

### Output Capacitor

The MIC37150/51/52/53 requires an output capacitor for stable operation. As a  $\mu\text{Cap}$  LDO, the MIC37150/51/52/53 can operate with ceramic output capacitors as long as the amount of capacitance is  $47\mu\text{F}$  or greater. For values of output capacitance lower than  $47\mu\text{F}$ , the recommended ESR range is  $200\text{m}\Omega$  to  $2\Omega$ . The minimum value of output capacitance recommended for the MIC37151 is  $10\mu\text{F}$ .

For  $47\mu\text{F}$  or greater, the ESR range recommended is less than  $1\Omega$ . Ultra-low ESR ceramic capacitors are recommended for output capacitance of  $47\mu\text{F}$  or greater to help improve transient response and noise reduction at high frequency. X7R/X5R dielectric-type ceramic capacitors are recommended because of their temperature performance. X7R-type capacitors change capacitance by 15% over their operating temperature range and are the most stable type of ceramic capacitors. Z5U and Y5V dielectric capacitors change value by as much as 50% and 60% respectively over their operating temperature ranges. To use a ceramic chip capacitor with Y5V dielectric, the value must be much higher than an X7R ceramic capacitor to ensure the same minimum capacitance over the equivalent operating temperature range. The MIC37150/51/52/53 has excellent transient response to variations in input voltage and load current. The device has been designed to respond quickly to load current variations and input voltage variations. Large output capacitors are not required to obtain this performance. A standard  $47\mu\text{F}$  output capacitor, is all that is required. Larger values help to improve performance even further.

### Input Capacitor

An input capacitor of  $1.0\mu\text{F}$  or greater is recommended when the device is more than 4 inches away from the bulk and supply capacitance, or when the supply is a battery. Small, surface-mount chip capacitors can be used for the bypassing. The capacitor should be placed within 1" of the device for optimal performance. Larger values will help to improve ripple rejection by bypassing the input to the regulator, further improving the integrity of the output voltage.

### Transient Response and 3.3V to 2.5V, 2.5V to 1.8V or 1.65V, or 2.5V to 1.5V Conversions

The MIC37150/51/52/53 has excellent transient response to variations in input voltage and load current. The device has been designed to respond quickly to

load current variations and input voltage variations. Large output capacitors are not required to obtain this performance. A standard 10 $\mu$ F output capacitor, preferably tantalum, is all that is required. Larger values help to improve performance even further.

By virtue of its low dropout voltage, this device does not saturate into dropout as readily as similar NPN-based designs. When converting from 3.3V to 2.5V, 2.5V to 1.8V or 1.65V, or 2.5V to 1.5V, the NPN-based regulators are already operating in dropout, with typical dropout requirements of 1.2V or greater. To convert down to 2.5V without operating in dropout, NPN-based regulators require an input voltage of 3.7V at the very least. The MIC37150/51/52/53 regulator will provide excellent performance with an input as low as 3.0V or 2.25V, respectively. This gives the PNP-based regulators a distinct advantage over older, NPN-based linear regulators.

#### Minimum Load Current

The MIC37150/51/52/53 regulator is specified between finite loads. If the output current is too small, leakage currents dominate and the output voltage rises. A 10mA minimum load current is necessary for proper operation.

#### Error Flag

The MIC37151 and MIC37153 feature an error flag circuit that monitors the output voltage and signals an error condition when the voltage 5% below the nominal output voltage. The error flag is an open-collector output that can sink 10mA during a fault condition.

Low output voltage can be caused by a number of problems, including an overcurrent fault (device in current limit) or low input voltage. The flag is inoperative during overtemperature shutdown.

#### Enable Input

The MIC37151/37152/37153 also features an enable input for on/off control of the device. Its shutdown state draws “zero” current (only microamperes of leakage). The enable input is TTL/CMOS compatible for simple logic interface, but can be connected to up to  $V_{IN}$ . When enabled, it draws approximately 15 $\mu$ A.

#### Adjustable Regulator Design

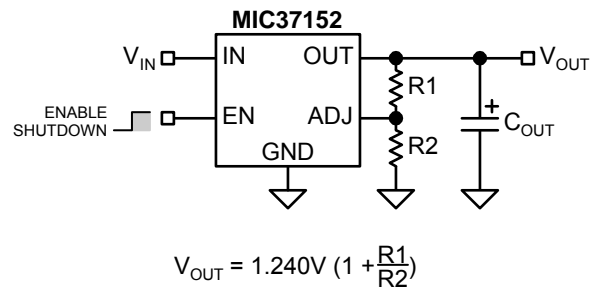

**Figure 1. Adjustable Regulator with Resistors**

The MIC37152 and MIC37153 allow programming the output voltage anywhere between 1.24V and the 5.5V maximum operating rating of the family. Two resistors are used. Resistors can be quite large, up to 1M $\Omega$ , because of the very high input impedance and low bias current of the sense comparator: The resistor values are calculated by:

$$R1 = R2 \left( \frac{V_{OUT}}{1.240} - 1 \right)$$

Where  $V_{OUT}$  is the desired output voltage. Figure 1 shows component definition. Applications with widely varying load currents may scale the resistors to draw the minimum load current required for proper operation (see above).

# Package Information

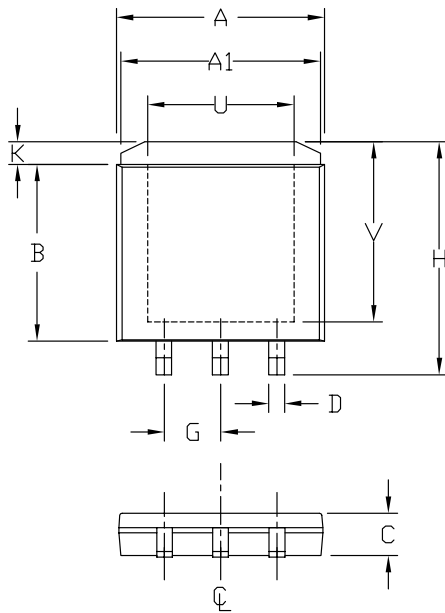

|    | INCHES |       | MILLIMETERS |       |
|----|--------|-------|-------------|-------|
|    |        |       |             |       |
| A  | 0.365  | 0.375 | 9.27        | 9.52  |
| A1 | 0.350  | 0.360 | 8.89        | 9.14  |
| B  | 0.310  | 0.320 | 7.87        | 8.13  |
| C  | 0.070  | 0.080 | 1.78        | 2.03  |
| D  | 0.025  | 0.031 | 0.63        | 0.79  |
| E  | 0.010  | BSC   | 0.25        | BSC   |
| G  | 0.100  | BSC   | 2.54        | BSC   |
| H  | 0.410  | 0.420 | 10.41       | 10.67 |
| K  | 0.030  | 0.050 | 0.76        | 1.27  |
| L  | 0.001  | 0.005 | 0.03        | 0.13  |
| M  | 0.035  | 0.045 | 0.89        | 1.14  |
| N  | 0.010  | BSC   | 0.25        | BSC   |
| P  | 0.031  | 0.041 | 0.79        | 1.04  |
| R  | 0°     | 6°    | 0°          | 6°    |
| U  | 0.256  | BSC   | 6.50        | BSC   |
| V  | 0.316  | BSC   | 8.03        | BSC   |

1. DIMENSION DOES NOT INCLUDE MOLD FLASH OR PROTRUSIONS.
2. DIMENSION INCLUDES PLATING THICKNESS.

## 3-Pin S-PAK (R)

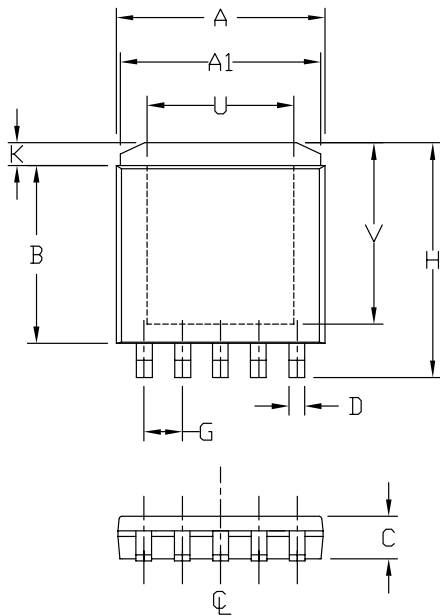

|    | INCHES |       | MILLIMETERS |       |
|----|--------|-------|-------------|-------|
|    |        |       |             |       |
| A  | 0.365  | 0.375 | 9.27        | 9.52  |
| A1 | 0.350  | 0.360 | 8.89        | 9.14  |
| B  | 0.310  | 0.320 | 7.87        | 8.13  |
| C  | 0.070  | 0.080 | 1.78        | 2.03  |
| D  | 0.025  | 0.031 | 0.63        | 0.79  |
| E  | 0.010  | BSC   | 0.25        | BSC   |
| G  | 0.067  | BSC   | 1.70        | BSC   |
| H  | 0.410  | 0.420 | 10.41       | 10.67 |
| K  | 0.030  | 0.050 | 0.76        | 1.27  |
| L  | 0.001  | 0.005 | 0.03        | 0.13  |
| M  | 0.035  | 0.045 | 0.89        | 1.14  |
| N  | 0.010  | BSC   | 0.25        | BSC   |
| P  | 0.031  | 0.041 | 0.79        | 1.04  |
| R  | 0°     | 6°    | 0°          | 6°    |
| U  | 0.256  | BSC   | 6.50        | BSC   |
| V  | 0.316  | BSC   | 8.03        | BSC   |

1. DIMENSION DOES NOT INCLUDE MOLD FLASH OR PROTRUSIONS.
2. DIMENSION INCLUDES PLATING THICKNESS.

## 5-Pin S-PAK (R)

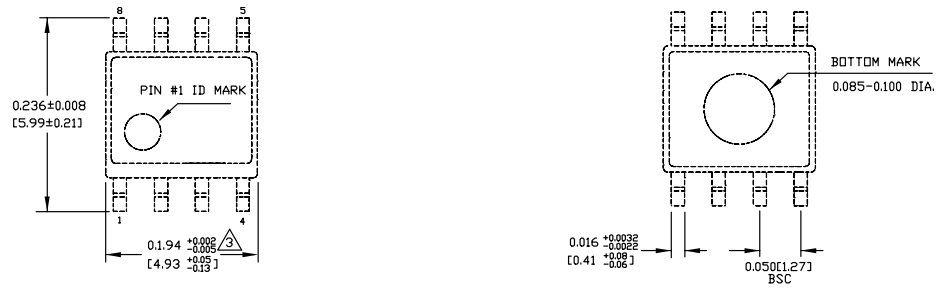

TOP VIEW

BOTTOM VIEW

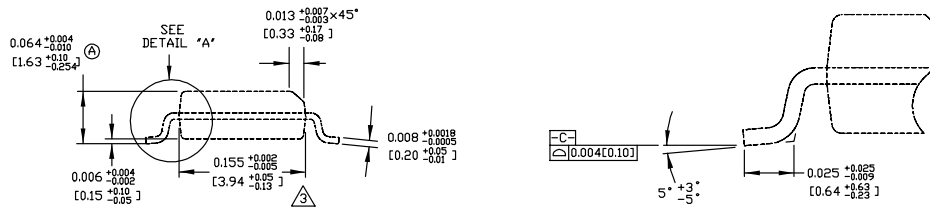

END VIEW

DETAIL "A"

- NOTES:  
 1. DIMENSIONS ARE IN INCHES[MM].  
 2. CONTROLLING DIMENSION: INCHES.  
 3. DIMENSION DOES NOT INCLUDE MOLD FLASH OR PROTRUSIONS, EITHER OF WHICH SHALL NOT EXCEED 0.010[0.25] PER SIDE.

8-Pin SOIC (M)

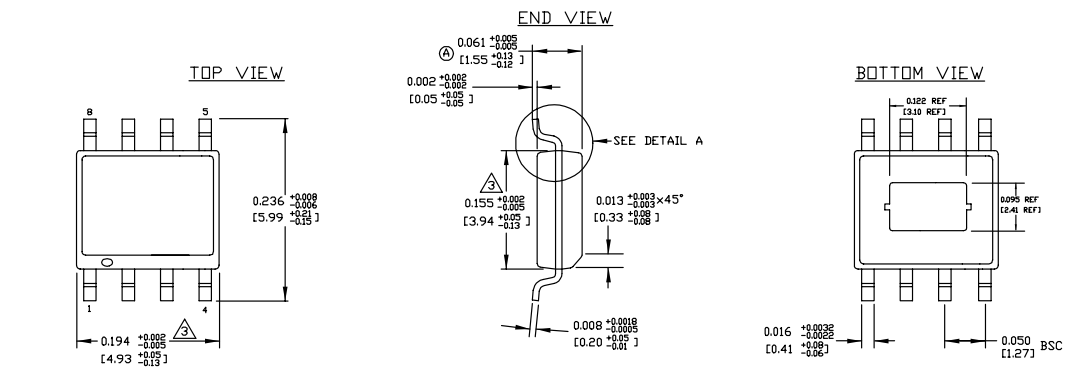

TOP VIEW

END VIEW

BOTTOM VIEW

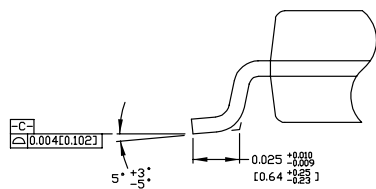

DETAIL "A"

- NOTES:  
 1. DIMENSIONS ARE IN INCHES[MM].  
 2. CONTROLLING DIMENSION: INCHES.  
 3. DIMENSION DOES NOT INCLUDE MOLD FLASH OR PROTRUSIONS, EITHER OF WHICH SHALL NOT EXCEED 0.006[0.15] PER SIDE.

8-Pin SOIC (ME)

---

**MICREL, INC. 2180 FORTUNE DRIVE SAN JOSE, CA 95131 USA**  
TEL +1 (408) 944-0800 FAX +1 (408) 474-1000 WEB <http://www.micrel.com>

The information furnished by Micrel in this data sheet is believed to be accurate and reliable. However, no responsibility is assumed by Micrel for its use. Micrel reserves the right to change circuitry and specifications at any time without notification to the customer.

Micrel Products are not designed or authorized for use as components in life support appliances, devices or systems where malfunction of a product can reasonably be expected to result in personal injury. Life support devices or systems are devices or systems that (a) are intended for surgical implant into the body or (b) support or sustain life, and whose failure to perform can be reasonably expected to result in a significant injury to the user. A Purchaser's use or sale of Micrel Products for use in life support appliances, devices or systems is a Purchaser's own risk and Purchaser agrees to fully indemnify Micrel for any damages resulting from such use or sale.

© 2003 Micrel, Incorporated.