

PLEASE CHECK WWW.MOLEX.COM FOR LATEST PART INFORMATION

Part Number: [0930502004](#)
Status: **Active**
Overview: rast_25_connector_system
Description: 2.50mm (.098") Pitch Appli-Mate RAST 2.5 Female Connector, Glow Wire Compliant, 7 Circuits, Natural, Open Endwalls, Positions B, C, F & H Removed

Documents:

[Drawing \(PDF\)](#) [RoHS Certificate of Compliance \(PDF\)](#)
[Product Specification PS-99020-0040 \(PDF\)](#)

Agency Certification

CSA LR19980
 UL E29179

General

Product Family IDT and Solder Connectors
 Series [93050](#)
 Crimp Quality Equipment Yes
 Overview [rast_25_connector_system](#)
 Product Name RAST 2.5

Physical

Circuits (Loaded) 7
 Circuits (maximum) 7
 Color - Resin Natural
 Durability (mating cycles max) 10
 Flammability 94V-2
 Gender Female
 Glow-Wire Compliant Yes
 Lock to Mating Part None
 Material - Metal Phosphor Bronze
 Material - Plating Mating Tin
 Material - Plating Termination Tin
 Material - Resin Polyester
 Number of Rows 1
 Packaging Type Tray
 Panel Mount No
 Pitch - Mating Interface (in) 0.098 In
 Pitch - Mating Interface (mm) 2.50 mm
 Pitch - Term. Interface (in) 0.098 In
 Pitch - Term. Interface (mm) 2.50 mm
 Plating min: Mating (µin) 40
 Plating min: Mating (µm) 1.00
 Plating min: Termination (µin) 40
 Plating min: Termination (µm) 1.00
 Polarized to Mating Part No
 Temperature Range - Operating -20°C to +60°C
 Wire Size AWG N/A

Electrical

Current - Maximum per Contact 2A
 Voltage - Maximum 32V AC

Material Info

Reference - Drawing Numbers

Application Specification AS-99033-0008

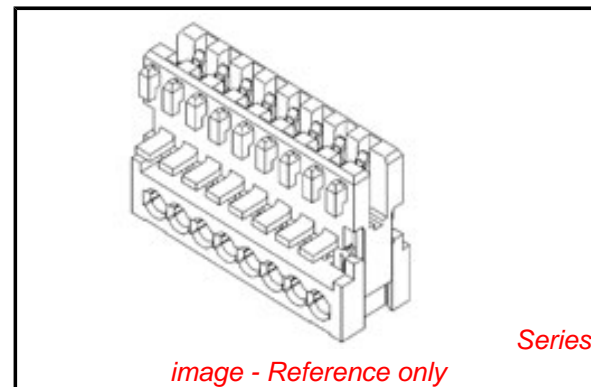

EU RoHS

ELV and RoHS Compliant
REACH SVHC Contains SVHC: No
Halogen-Free Status

China RoHS



Need more information on product environmental compliance?

Email productcompliance@molex.com
 For a multiple part number RoHS Certificate of Compliance, [click here](#)

Please visit the [Contact Us](#) section for any non-product compliance questions.

Search Parts in this Series

[93050Series](#)

Mates With

Appli-Mate RAST 2.5 Header [93070](#)

Packaging Specification
Product Specification
Sales Drawing

PK-90871-001
PS-99020-0040
SD-93050-001

This document was generated on 06/07/2010

PLEASE CHECK WWW.MOLEX.COM FOR LATEST PART INFORMATION

POSITION OF COLOUR STRIPE (see note 3)

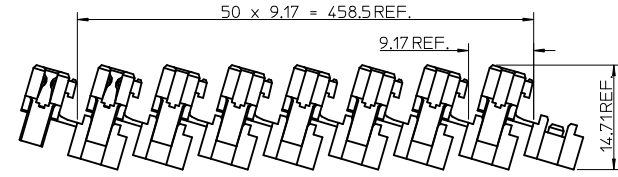
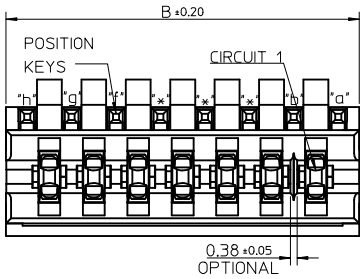
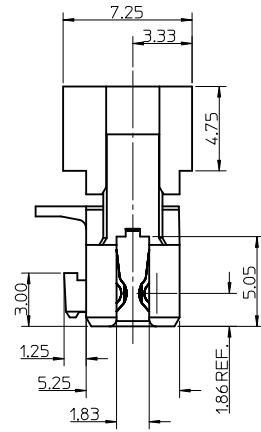
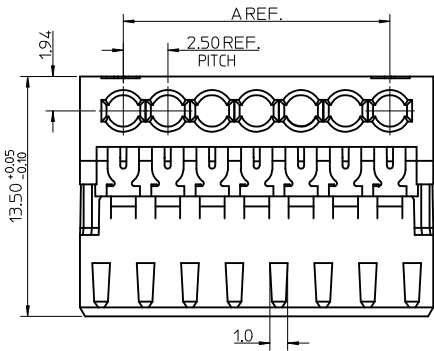
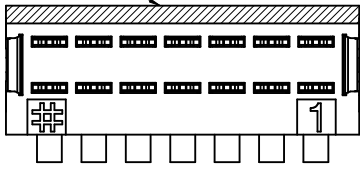

SHIPPING ARRANGEMENT SCALE 2:1

CCT	"A"	"B"
3	5.0	9.875
4	7.5	12.375
5	10.0	14.875
6	12.5	17.375
7	15.0	19.875
8	17.5	22.375
9	20.0	24.875
10	22.5	27.375
11	25.0	29.875
12	27.5	32.375
13	30.0	34.875

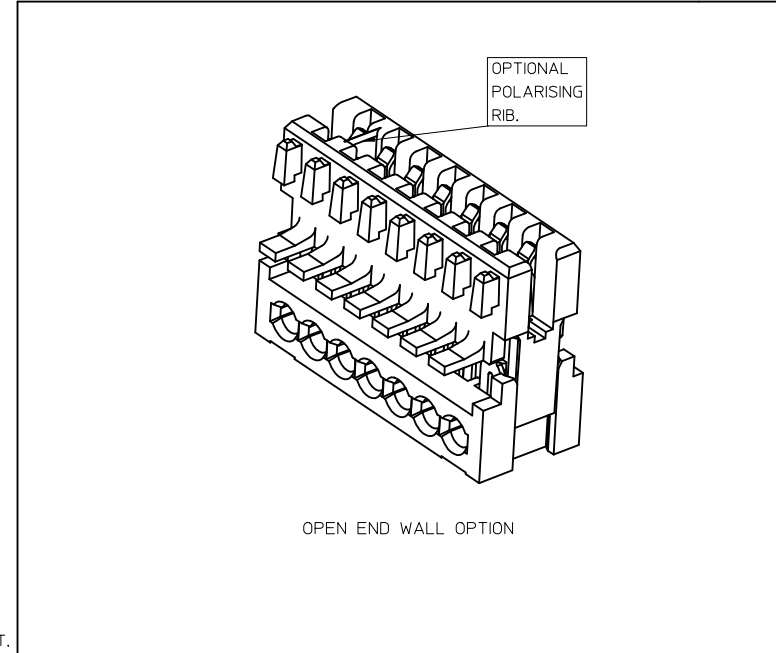

NOTES:

- REFER TO PRODUCT SPECIFICATION: PS-99020-0040.
- MATERIAL: HOUSING - POLYESTER (PBT)
UL94-V2. COLOUR NATURAL.
TERMINAL: PHOSPHOR BRONZE 0.30 REF. THICK - PLATING
HOT TIN DIP.
- COLOUR STRIPE IS OPTIONAL. AVAILABLE IN THE FOLLOWING COLOURS: RED, GREEN, BLUE.
(BLACK SIGNIFIES CUSTOMER SPECIFIC CONFIGURATION).
- REFER TO PACKAGING SPEC (PK-90871-001)
- REFER TO APPLICATION SPEC (AS-99033-0008)
- FOR CIRCUIT SIZES LARGER THAN 13CCT - CONTACT ENG. DEPT.

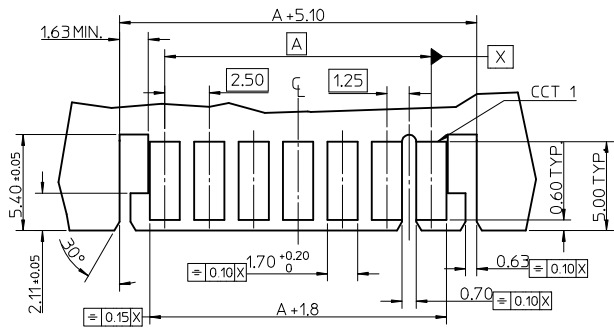

- PCB LAYOUT FOR 7CCT CONNECTOR
(WITH OPTIONAL POSITIONAL RIB SLOT BETWEEN CCT 1 & 2)
- RECOMMENDED PCB THICKNESS 1.5±0.14

ADDED NEW P/N'S EC NO: E2010-0339 DRAWN: BMAGUIRE 2010/03/30 CHKD: NMCNAMARA 2007/07/09 APPR: BMAGUIRE 2010/05/05	QUALITY SYMBOLS ▽=0 ▽=0	GENERAL TOLERANCES (UNLESS SPECIFIED)		DIMENSION STYLE MM ONLY		SCALE 5:1	DESIGN UNITS METRIC	THIRD ANGLE PROJECTION
		mm	INCH	DRAWN BY TTOURISH	DATE 2007/07/07	TITLE APPLI-MATE 2.5 FEMALE G.W.T. 750 VERSION		
REV	DESCRIPTION	4 PLACES	± 0.05	± 0.0025	CHECKED BY NMCNAMARA	DATE 2007/07/09	MOLEX INCORPORATED DOCUMENT NO. SD-93050-001	
		3 PLACES	± 0.10	± 0.0050	APPROVED BY BMAGUIRE	DATE 2007/07/09		
		2 PLACES	± 0.20	± 0.0100	MATERIAL NO.		THIS DRAWING CONTAINS INFORMATION THAT IS PROPRIETARY TO MOLEX INCORPORATED AND SHOULD NOT BE USED WITHOUT WRITTEN PERMISSION	
		1 PLACE	± 0.25	± 0.0125	SIZE A 2			

3 CIRCUIT

MOLEX PART NO.	TERMINAL VOID POSITION	REMOVED POSITION KEYS	CONFIGURATION (SEE NOTE 1)	ENDWALLS	POLARIZING RIB	COLOUR STRIPE
93050-0001	NONE	NONE		OPEN	NONE	NONE
93050-0003	NONE	b d		OPEN	NONE	NONE
93050-0005	NONE	b		OPEN	NONE	NONE
93050-0006	NONE	d		OPEN	NONE	NONE
93050-0007	NONE	a c		OPEN	NONE	NONE
93050-0008	NONE	a b		OPEN	NONE	NONE
93050-0009	NONE	c d		OPEN	NONE	NONE
93050-0012	NONE	b c		OPEN	BETWEEN CCT 1&2	NONE
93050-0013	NONE	a		OPEN	BETWEEN CCT 1&2	NONE
93050-0014	NONE	c		OPEN	BETWEEN CCT 2&3	BLUE
93050-0016	NONE	NONE		OPEN	BETWEEN CCT 1&2	NONE
93050-0017	NONE	NONE		OPEN	BETWEEN CCT 2&3	NONE
93050-0018	NONE	a b c		OPEN	NONE	NONE
93050-0019	NONE	c		OPEN	NONE	NONE
93050-0020	NONE	a d		OPEN	NONE	NONE
93050-0021	NONE	NONE		OPEN	NONE	BLUE
93050-0022	NONE	NONE		OPEN	BETWEEN CCT 1&2	BLUE
93050-0023	NONE	b c		OPEN	NONE	NONE
93050-0024	NONE	a		OPEN	NONE	NONE

4 CIRCUIT

MOLEX PART NO.	TERMINAL VOID POSITION	REMOVED POSITION KEYS	CONFIGURATION (SEE NOTE 1)	ENDWALLS	POLARIZING RIB	COLOUR STRIPE
93050-0501	NONE	NONE		OPEN	NONE	NONE
93050-0502	NONE	a b d e		OPEN	BETWEEN CKT 1&2	NONE
93050-0503	NONE	ALL		OPEN	BETWEEN CKT 3&4	NONE
93050-0504	NONE	ALL		OPEN	BETWEEN CKT 3&4	BLUE
93050-0505	NONE	c e		OPEN	NONE	NONE
93050-0506	NONE	b c		OPEN	NONE	NONE
93050-0507	NONE	NONE		OPEN	BETWEEN CKT 2&3	NONE
93050-0508	NONE	a d e		OPEN	NONE	NONE
93050-0509	NONE	a c		OPEN	NONE	NONE
93050-0751	NONE	b e		1st CLOSED LAST OPEN	NONE	NONE
93050-0510	NONE	b d		OPEN	NONE	NONE
93050-0511	NONE	b e		OPEN	NONE	NONE
93050-0512	NONE	NONE		OPEN	NONE	BLUE

6 CIRCUIT

MOLEX PART NO.	TERMINAL VOID POSITION	REMOVED POSITION KEYS	CONFIGURATION (SEE NOTE 1)	ENDWALLS	POLARIZING RIB	COLOUR STRIPE
93050-1501	NONE	NONE		OPEN	NONE	NONE
93050-1502	CCT 2, 4	NONE		OPEN	NONE	NONE
93050-1503	NONE	a d e f		OPEN	NONE	NONE
93050-1504	CCT 2, 5	b c d e g		OPEN	NONE	NONE
93050-1505	NONE	b d e g		OPEN	NONE	NONE
93050-1506	NONE	g		OPEN	NONE	NONE
93050-1507	NONE	b c d g		OPEN	NONE	NONE
93050-1508	NONE	b c e		OPEN	NONE	NONE
93050-1509	NONE	b c d e f		OPEN	NONE	NONE
93050-1510	CCT 3, 5	NONE		OPEN	NONE	NONE
93050-1513	CCT 2, 4	b c e		OPEN	BETWEEN 4&5	NONE

5 CIRCUIT

MOLEX PART NO.	TERMINAL VOID POSITION	REMOVED POSITION KEYS	CONFIGURATION (SEE NOTE 1)	ENDWALLS	POLARIZING RIB	COLOUR STRIPE
93050-1001	NONE	NONE		OPEN	NONE	NONE
93050-1002	NONE	c d e		OPEN	NONE	NONE
93050-1003	NONE	NONE		OPEN	BETWEEN CKT 2&3	NONE
93050-1004	NONE	c d		OPEN	NONE	NONE
93050-1005	CCT 2, 3, 4	e		OPEN	NONE	NONE

7 CIRCUIT



MOLEX PART NO.	TERMINAL VOID POSITION	REMOVED POSITION KEYS	CONFIGURATION (SEE NOTE 1)	ENDWALLS	POLARIZING RIB	COLOUR STRIPE
93050-2001	NONE	NONE		OPEN	NONE	NONE
93050-2002	cct 2, 3, 5	c d f h		OPEN	NONE	NONE
93050-2003	NONE	a c d e f g		OPEN	NONE	NONE
93050-2004	NONE	b c f h		OPEN	NONE	NONE
93050-2005	NONE	b c d e f		OPEN	NONE	NONE
93050-2009	NONE	NONE		OPEN	BETWEEN 6&7	NONE

NOTES

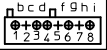
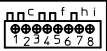
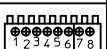
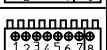
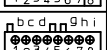
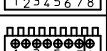
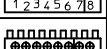

- + DENOTES TERMINAL VOIDED POSITION
- ⊕ DENOTES TERMINAL LOADED POSITION
- | DENOTES POLARIZING RIB POSITION

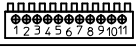
SEE SHEET 1 ELEC NO: E2010-0339 DRAWN BY: B.MAGUIRE CHKD BY: M.NAMARA APPR: B.MAGUIRE 2010/03/30 2007/07/09 2010/05/05	QUALITY SYMBOLS ▽=0 ▽=0 ▽=0	GENERAL TOLERANCES (UNLESS SPECIFIED) mm INCH 4 PLACES ±.--- ±.--- 3 PLACES ±.05 ±.--- 2 PLACES ±.10 ±.--- 1 PLACE ±.02 ±.--- ANGULAR ±1/2°	DIMENSION STYLE MM ONLY DRAWN BY DATE T.TOURISH 2007/07/07 CHECKED BY DATE M.NAMARA 2007/07/09 APPROVED BY DATE B.MAGUIRE 2007/07/09	SCALE 1:1 DESIGN UNITS METRIC	THIRD ANGLE PROJECTION	
		DRAFT WHERE APPLICABLE MUST REMAIN WITHIN DIMENSIONS				SEE CHART THIS DRAWING CONTAINS INFORMATION THAT IS PROPRIETARY TO MOLEX INCORPORATED AND SHOULD NOT BE USED WITHOUT WRITTEN PERMISSION
		MATERIAL NO. SD-93050-001				SHEET NO. 2 OF 3
		TITLE APPLI-MATE 2.5 FEMALE G.W.T. 750 VERSION				DOCUMENT NO.

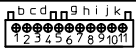
8 CIRCUIT						
MOLEX PART NO.	TERMINAL VOID POSITION	REMOVED POSITION KEYS	CONFIGURATION (SEE NOTE 1)	ENDWALLS	POLARIZING RIB	COLOUR STRIPE
93050-2501	NONE	NONE		OPEN	NONE	NONE
93050-2502	CCT 2, 5, 7	b c d f g h i		OPEN	NONE	NONE
93050-2503	NONE	c f h i		OPEN	NONE	NONE
93050-2504	NONE	NONE		OPEN	BETWEEN CKT 6&7	BLUE
93050-2505	NONE	NONE		OPEN	BETWEEN CKT 7&8	BLUE
93050-2506	NONE	b c d g h i		OPEN	NONE	NONE
93050-2507	NONE	NONE		OPEN	BETWEEN CKT 7&8	NONE
93050-2508	NONE	NONE		OPEN	BETWEEN CKT 6&7	NONE

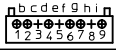

11 CIRCUIT						
MOLEX PART NO.	TERMINAL VOID POSITION	REMOVED POSITION KEYS	CONFIGURATION (SEE NOTE 1)	ENDWALLS	POLARIZING RIB	COLOUR STRIPE
93050-4001	NONE	NONE		OPEN	NONE	NONE
93050-4002	NONE	b c d e f g h i j k		OPEN	BETWEEN CCT 9&10	BLUE
93050-4003	NONE	b c d g h i j k		OPEN	NONE	NONE

12 CIRCUIT						
MOLEX PART NO.	TERMINAL VOID POSITION	REMOVED POSITION KEYS	CONFIGURATION (SEE NOTE 1)	ENDWALLS	POLARIZING RIB	COLOUR STRIPE
93050-4501	NONE	NONE		OPEN	NONE	NONE

9 CIRCUIT						
MOLEX PART NO.	TERMINAL VOID POSITION	REMOVED POSITION KEYS	CONFIGURATION (SEE NOTE 1)	ENDWALLS	POLARIZING RIB	COLOUR STRIPE
93050-3001	NONE	NONE		OPEN	NONE	NONE
93050-3002	CCT 3, 5, 8	b c d e f g h i		OPEN	NONE	NONE
93050-3003	NONE	NONE		OPEN	BETWEEN CKT 8&9	NONE

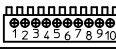
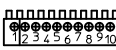
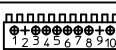
13 CIRCUIT						
MOLEX PART NO.	TERMINAL VOID POSITION	REMOVED POSITION KEYS	CONFIGURATION (SEE NOTE 1)	ENDWALLS	POLARIZING RIB	COLOUR STRIPE
93050-5001	NONE	NONE		OPEN	NONE	NONE

10 CIRCUIT						
MOLEX PART NO.	TERMINAL VOID POSITION	REMOVED POSITION KEYS	CONFIGURATION (SEE NOTE 1)	ENDWALLS	POLARIZING RIB	COLOUR STRIPE
93050-3501	NONE	NONE		OPEN	NONE	NONE
93050-3502	NONE	NONE		OPEN	BETWEEN CCT 1&2	NONE
93050-3503	CCT 2, 9	NONE		OPEN	NONE	BLUE

SEE SHEET 1 ELEC NO: E2010-0339 DRAWN: BMAGUIRE 2010/03/30 CHECKED: NMCNAMARA 2007/07/09 APPROVED: BMAGUIRE 2010/05/05	QUALITY SYMBOLS  	GENERAL TOLERANCES (UNLESS SPECIFIED) mm INCH 4 PLACES ± --- ± --- 3 PLACES ± 0.05 ± --- 2 PLACES ± 0.10 ± --- 1 PLACE ± 0.2 ± --- ANGULAR ± 1/2°		DIMENSION STYLE MM ONLY DRAWN BY DATE T TOURISH 2007/07/07 CHECKED BY DATE NMCNAMARA 2007/07/09 APPROVED BY DATE BMAGUIRE 2007/07/09		SCALE 1:1	DESIGN UNITS METRIC	 THIRD ANGLE PROJECTION
		TITLE APPLI-MATE 2.5 FEMALE G.W.T. 750 VERSION						
		MATERIAL NO. DOCUMENT NO. SHEET NO. SEE CHARTS SD-93050-001 3 OF 3						
		DRAFT WHERE APPLICABLE MUST REMAIN WITHIN DIMENSIONS THIS DRAWING CONTAINS INFORMATION THAT IS PROPRIETARY TO MOLEX INCORPORATED AND SHOULD NOT BE USED WITHOUT WRITTEN PERMISSION						