

SL-SMT 3.5

... reduces costs in the production process

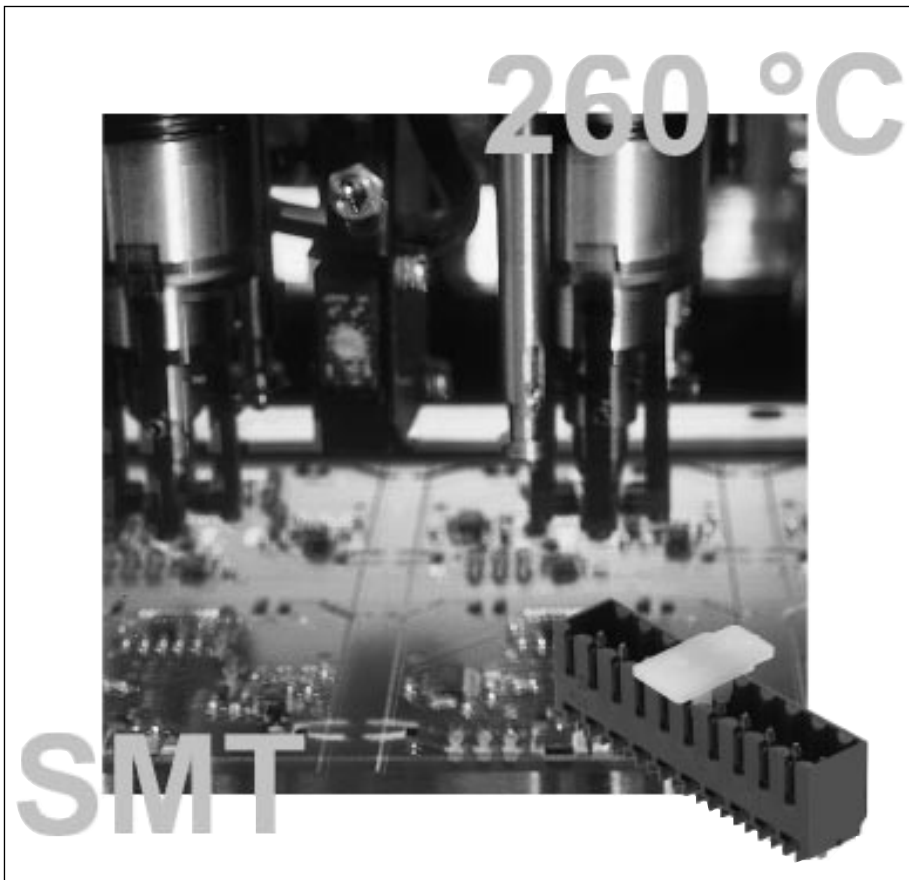

SL-SMT 3.5 is the high temperature resistant pin header for the 3.5 mm pitch range specially developed to be compatible with Reflow production processes. Existing pcb connector headers cannot withstand the high temperatures experienced in Reflow soldering - up to 260 °C. The SL-SMT has been designed using LCP (Liquid Crystal Polymer) which is stable at these high temperatures.

In addition, conventional assembly of pcb modules requires both Wave soldering for standard THT (Through-Hole-Technology) components like pcb connector headers; and then Reflow soldering for the SMT (Surface-Mount-Technology) components. With the SL-SMT, which uses THR technology, the Wave solder operation is not needed. The shorter THR solder pins offer the flexibility of SMT components but achieve a mechanical strength of 10x that of "Gull Wing" SMT components. This additional strength is of great importance for pcb connectors where connection operations put strain onto standard SMT solder joints.

The SL-SMT is not only suitable for the latest soldering techniques, it has also been designed to be compatible with standard automatic "Pick-and-Place" machines. "Tape-on-Reel" and "Tray" packaging enable fully automatic component placement of the 90° (horizontal) and 180° (vertical) pin headers. These products are available in the standard open-ended, closed-ended and flanged versions, and mate with any of the female socket connectors in our BL 3.5 range.

Advantages:

- up to 30% reduction in the number of production steps required
- stable at 260 °C - compatible for Convection and Vapour-phase Reflow soldering
- compatible for automatic "Pick-and-Place"
- THR gives 10x greater strength than "Gull Wing" SMT
- placement on both sides of pcb possible

USA

Weidmüller Inc.
821 Southlake Boulevard
Richmond, VA. 23236
Tel. (804) 794-2877 Fax (804) 794-0252

Great Britain

Weidmüller Ltd.
1 Abbey Wood Road, Kingshill, West Malling
Kent ME 19 4YT
Tel. (17 95) 58 09 99 Fax (17 32) 87 42 96

Other countries

Weidmüller Interface GmbH & Co.
Postfach 30 30
D-32720 Detmold
Tel. (0 52 31) 14-0 Fax (05 23 1) 14-20 83

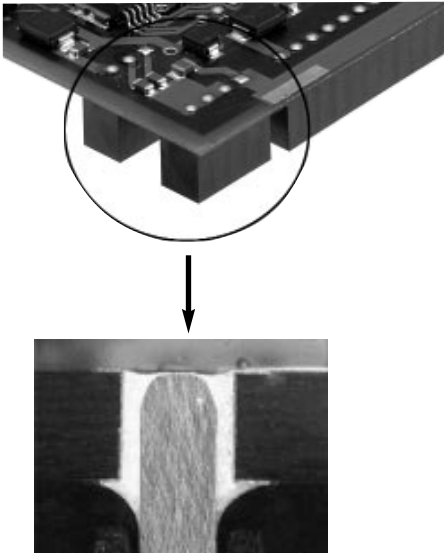

SL-SMT 3.5 pin headers

At the pcb level, the SL-SMT 3.5 pin header ensures a cost saving in the production process and, for field wiring, offers a free choice of connection technology thanks to an extensive range in 3.5 mm pitch.

Packaging types of the SL SMT 3.5

The packaging of the SL SMT 3.5 was conceived for the typical component placement process used for SMT components:

Automatic component placement:

- Tape-on-Reel (ToR)
- Tray

Manual component placement:

- Standard box (Std)

The high temperature resistant SL SMT 3.5 pin header can also be used in the wave soldering process, the advantage being that the plastic is resistant to high temperatures. For this application however, standard pin lengths are needed. These are available on request.

Technical data

Materials	
Insulation material	LCP, halogen-free
Colour	black
Fusion temperature	335 °C
Flammability class	UL 94 V0
Basis contact material	CuSn
Contact plating ¹⁾	tin-plated

Characteristic system values	
Pitch	3.50 mm
Connection method	Through-Hole-Reflow
Processing method	convection and vapour phase soldering
Soldering pin length ²⁾	1.5 mm
PCB hole diameter ³⁾	1.4 ^{+0.1} mm
Insulation resistance	≥ 10 ⁴ MΩ
Through resistance	≤ 4.2 mΩ
Operating temperature range with BL 3.5	-20...+100 °C

VDE 0110 4.97 rated data			
Rated current ⁴⁾	13 A		
Overvoltage category/Pollution severity			
Rated voltage	125 V	125 V	250 V
Impulse voltage	2.5 kV	2.5 kV	2.5 kV

UL rated data	
Rated voltage, industrial	V~ 300
Rated current	10 A

CSA rated data	
Rated voltage, industrial	V~ 300
Rated current	10 A

Application notes

- 1) gold-plated contacts available on request
- 2) additional soldering pin lengths on request
- 3) pls. see chapter "design recommendation"
- 4) referred to 20 °C ambient temperature, rated cross-section and max. poles in connection with BL 3.5

For the mounting of PCBs it should be noted, that the rated data given in the data sheet relate only to the connection elements. The necessary creepage and clearance paths must be observed in connection with the respective applicant in accordance to VDE 0110. The current-carrying capacity is to be determined according to DIN IEC 326 part 3.

Weidmüller connectors are tested according to the DIN 0627 standard, and are valid for its field of applications. Provided that the connectors are used for the intended purpose, all requirements with respect to the occurring of electrical, mechanical, thermic and corrosive stress will be satisfied.

Derating curves

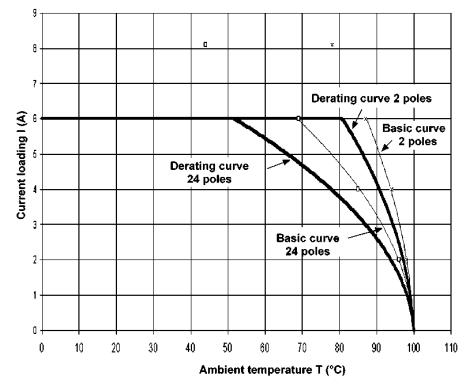

BL 3.5/SL-SMT 3.5/90°, 2 and 24 poles
Conductor H05V-K0.5mm²

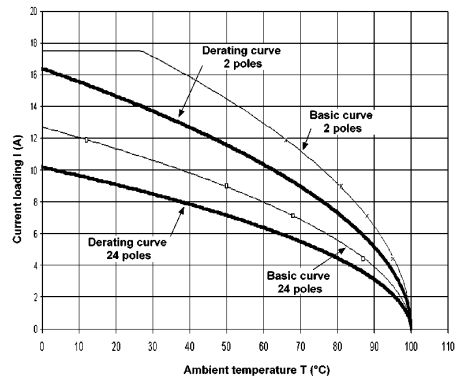

BL 3.5/SL-SMT 3.5/90°, 2 and 24 poles
Conductor H07V-K1.5mm²

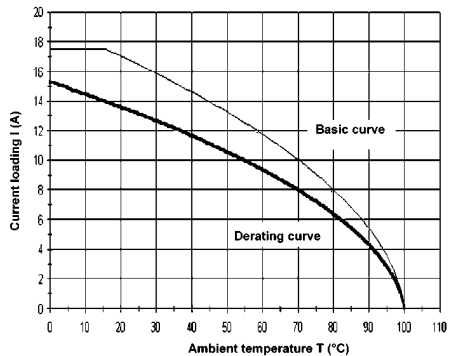

BL 3.5/SL-SMT 3.5, 24 poles
(conductor bridges over the reflow soldering point)
Conductor H07V-K1.5mm²

Machine oriented packaging "Tape-on-Reel"



Reel dimensions and position of pin headers

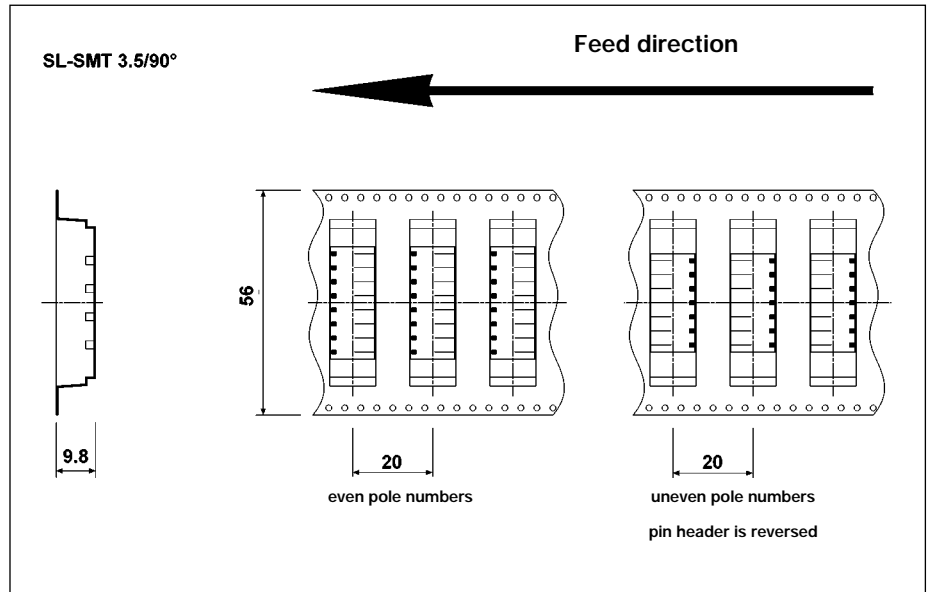

The pin headers for the 90° and 180° versions of the SL-SMT 3.5 are available in "Tape-on-Reel" for automatic component replacement.

The reels are anti-static, have a diameter of 330 mm, and are designed for all commercially available feeders.

The tapes used conform to the standard IEC 60286-3 and are made of anti-static, black polystyrene. The tape is covered with a transparent plastic film.

A high temperature resistant pick-and-place pad is located in the middle of the pin header for automatic gripping of the straight pin header SL-SMT 3.5/180°. This pick-and-place pad is included in the "Tape-on-Reel" packaging.

The angled SL-SMT 3.5/90° pin header is positioned so that no pick-and-place pad is needed for automatic gripping.

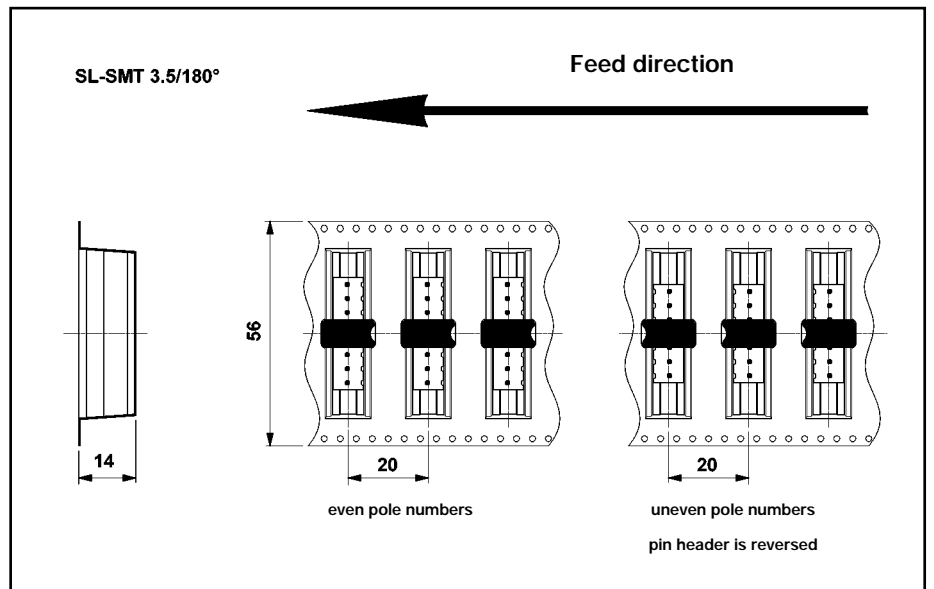

Unit packaging "Tape-on-Reel"

Quantity of SL-SMT 3.5 on the reel open and closed versions

Tape width 56 mm
Reel diameter 330 mm

Poles	SL-SMT 3.5/90	SL-SMT 3.5/180
2...11	250 pcs.	200 pcs.

In tape, the open and closed versions of the SL-SMT 3.5 are currently only available up to 11 poles. Additional tape widths on request.

Unit packaging "Tape-on-Reel"

Quantity of SL-SMT 3.5 on the reel flanged version

Tape width 56 mm
Reel diameter 330 mm

Poles	SL-SMT 3.5/90	SL-SMT 3.5/180
2...9	250 pcs.	200 pcs.

In tape, the flanged version of the SL-SMT 3.5 is currently only available up to 9 poles. Additional tape widths on request.

Machine oriented packaging

"Tray"



The trays are adapted to the SL-SMT 3.5 pin headers and are based on the standard EN 60286-5. The tray material consists of black anti-static polystyrene. For transport, the trays are covered with a transparent cover.

A high temperature resistant pick-and-place pad is placed in the middle of the pin header for automatic gripping of the straight pin header SL-SMT 3.5/180° using a vacuum pipette.

This pad is included in the tray packaging. The angled pin header SL-SMT 3.5/90° was conceived to ensure that no pick-and-place pad is needed for automatic gripping.

Tray dimensions and position of SL-SMT 3.5 pin headers

The optimum positioning points for the vacuum pipette depend on the length of the connectors (open, closed or flange). In the tray drawing, we have marked these points with Start X and Step X for the X axis with reference to the example of an SL-SMT 3.5/24/90 without a flange. The following table indicates the dimensions for the X and Y axes for the different pole numbers and versions.

To facilitate adjustment on the machine, the label shows the necessary dimension in short form.

Example of Label

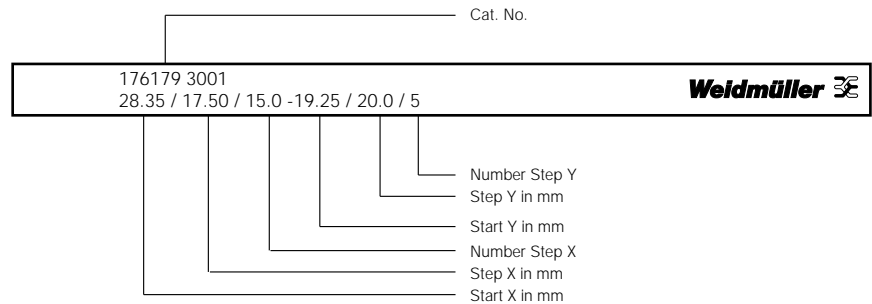

Tray dimensions SL-SMT 3.5/90° and 180° open and closed versions

X-values 90°/180°

No. Poles	Start X (mm)	Step X (mm)	Number Step X
-	-	-	-
-	-	-	-
4	28.35	17.50	15
5	30.10	21.00	13
6	31.85	24.50	11
7	33.60	28.00	9
8	35.35	31.50	8
9	37.10	35.00	7
10	38.85	38.50	6
11	40.60	42.00	6
12	42.35	45.50	5
13	44.10	49.00	5
14	45.85	52.50	4
15	47.60	56.00	4
16	49.35	59.50	3
17	51.10	63.00	3
18	52.85	66.50	3
19	54.60	70.00	3
20	56.35	73.50	3
21	58.10	77.00	2
22	59.85	80.50	2
23	61.60	84.00	2
24	63.35	87.50	2

Y-values 90°

Start Y (mm)	Step Y (mm)	Number Step Y
19.25	20.00	5

Tray dimensions SL-SMT 3.5/90° and 180° flange versions

X-values 90°/180°

No. Poles	Start X (mm)	Step X (mm)	Number Step X
2	28.35	17.50	15
3	30.10	21.00	13
4	31.85	24.50	11
5	33.60	28.00	9
6	35.35	31.50	8
7	37.10	35.00	7
8	38.85	38.50	6
9	40.60	42.00	6
10	42.35	45.50	5
11	44.10	49.00	5
12	45.85	52.50	4
13	47.60	56.00	4
14	49.35	59.50	3
15	51.10	63.00	3
16	52.85	66.50	3
17	54.60	70.00	3
18	56.35	73.50	3
19	58.10	77.00	2
20	59.85	80.50	2
21	61.60	84.00	2
22	63.35	87.50	2
23	65.10	91.00	2
24	66.85	94.50	2

Y-values 180°

Start Y (mm)	Step Y (mm)	Number Step Y
17.95	20.00	5

Unit packaging "Tray"

SL-SMT 3.5/90° and 180° open and closed versions

No. Poles	Tray content
2...3	on request
4	96 pcs.
5	84 pcs.
6	72 pcs.
7	60 pcs.
8	54 pcs.
9	48 pcs.
10...11	42 pcs.
12...13	36 pcs.
14...15	30 pcs.
16...20	24 pcs.
21...24	18 pcs.

Unit packaging "Tray"

SL-SMT 3.5/90° and 180° flange version

No. Poles	Tray content
2	96 pcs.
3	84 pcs.
4	72 pcs.
5	60 pcs.
6	54 pcs.
7	48 pcs.
8...9	42 pcs.
10...11	36 pcs.
12...13	30 pcs.
14...18	24 pcs.
19...24	18 pcs.

Machine oriented packaging

"Tray"

Tray dimensions and position of pin headers SL-SMT 3.5/90°

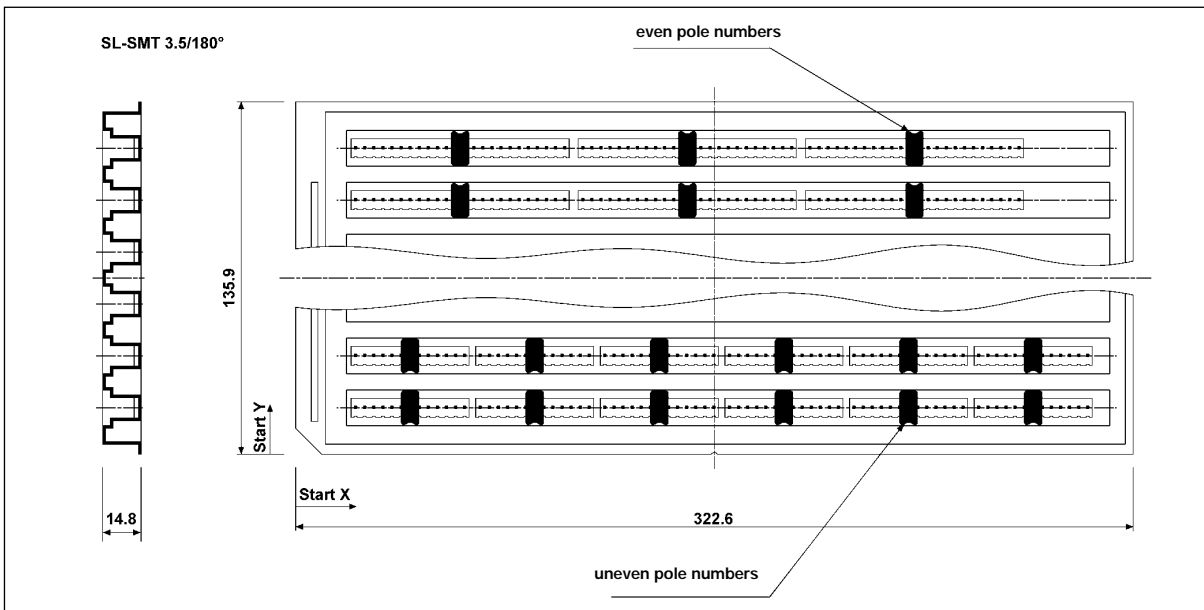
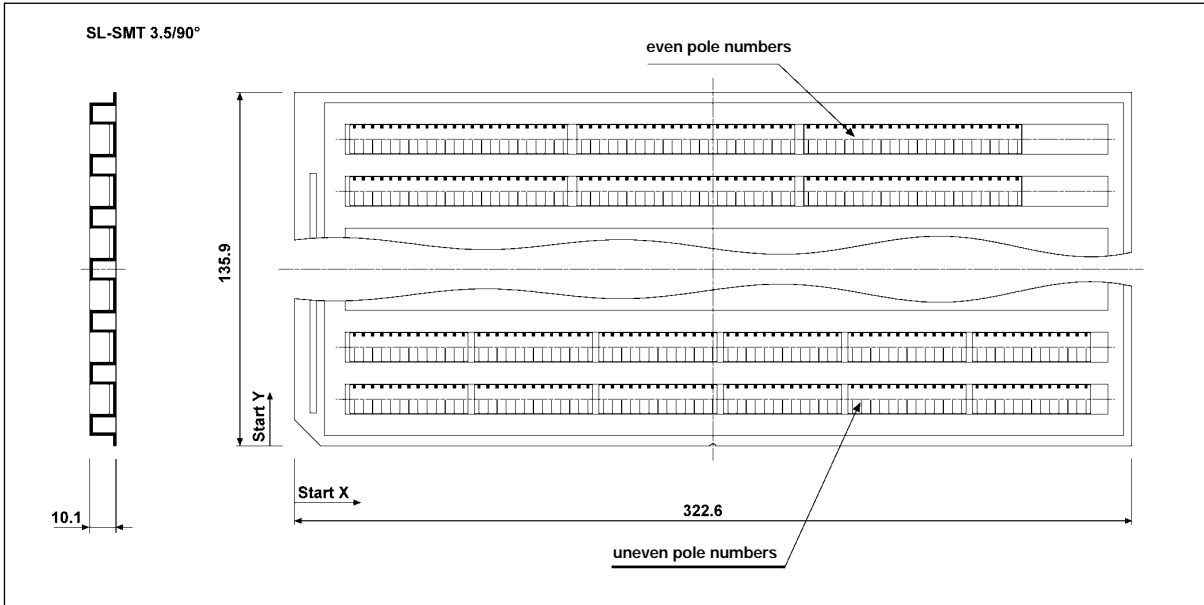

User preparation of the SL-SMT 3.5 in the "Tray"

For user preparation of the SL-SMT 3.5 in the "Tray", we also offer all components separately.

Tray empty

Type	Description	Cat. No.	Qty.
Tray SL-SMT 3.5/90	for SL-SMT 3.5/4...24/90, SL-SMT 3.5/4...24/90G and SL-SMT 3.5/2...24/90F	177210 0000	1
Tray SL-SMT 3.5/180	for SL-SMT 3.5/4...24/180, SL-SMT 3.5/4...24/180G and SL-SMT 3.5/2...24/180F	177215 0000	1
Tray-Deckel SL-SMT 3.5	for Trays SL-SMT 3.5/.../90 and SL-SMT 3.5/.../180 (open, closed, flange) - for covering and stacking the trays	177216 0000	1
PPP-SL-SMT 3.5/180	pick-and-place-pad for SL-SMT 3.5/2...24/180 (open, closed, flange)	176224 0000	500

SL-SMT 3.5 pin headers

Poles	Type	Order-No.	Qty.
2...4	SL-SMT 3.5/90 (open, closed, flange) and SL-SMT 3.5/180 (open, closed, flange)	see page 6+7	100
5...16	SL-SMT 3.5/90 (open, closed, flange) and SL-SMT 3.5/180 (open, closed, flange)	see page 6+7	50
17...24	SL-SMT 3.5/90 (open, closed, flange) and SL-SMT 3.5/180 (open, closed, flange)	see page 6+7	20

SL-SMT 3.5/90 pin headers

open ends
attachable without loss of poles

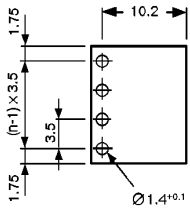
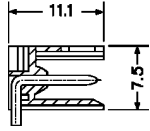

Pin length 1.5 mm
Colour

Poles	Type	Cat. No.	ToR	Tray	Std
2	SL-SMT 3.5/2/90	176177	4001	o. r. ¹⁾	2001
3	SL-SMT 3.5/3/90	176178	4001	o. r. ¹⁾	2001
4	SL-SMT 3.5/4/90	176179	4001	3001	2001
5	SL-SMT 3.5/5/90	176180	4001	3001	2001
6	SL-SMT 3.5/6/90	176181	4001	3001	2001
7	SL-SMT 3.5/7/90	176182	4001	3001	2001
8	SL-SMT 3.5/8/90	176183	4001	3001	2001
9	SL-SMT 3.5/9/90	176184	4001	3001	2001
10	SL-SMT 3.5/10/90	176185	4001	3001	2001
11	SL-SMT 3.5/11/90	176186	4001	3001	2001
12	SL-SMT 3.5/12/90	176187	o. r. ¹⁾	3001	2001
13	SL-SMT 3.5/13/90	176188	o. r. ¹⁾	3001	2001
14	SL-SMT 3.5/14/90	176189	o. r. ¹⁾	3001	2001
15	SL-SMT 3.5/15/90	176190	o. r. ¹⁾	3001	2001
16	SL-SMT 3.5/16/90	176191	o. r. ¹⁾	3001	2001
17	SL-SMT 3.5/17/90	176192	o. r. ¹⁾	3001	2001
18	SL-SMT 3.5/18/90	176193	o. r. ¹⁾	3001	2001
19	SL-SMT 3.5/19/90	176194	o. r. ¹⁾	3001	2001
20	SL-SMT 3.5/20/90	176195	o. r. ¹⁾	3001	2001
21	SL-SMT 3.5/21/90	176196	o. r. ¹⁾	3001	2001
22	SL-SMT 3.5/22/90	176197	o. r. ¹⁾	3001	2001
23	SL-SMT 3.5/23/90	176198	o. r. ¹⁾	3001	2001
24	SL-SMT 3.5/24/90	176199	o. r. ¹⁾	3001	2001

1) on request

Accessories

Description	Type	Cat. No.
Locking latch	BL/SL 3.5 VR OR	166931 0000
Coding element	BL/SL 3.50 KO OR	169343 0000
Light indicator	SL 3.5 FLA 1.5/8	159751 0000

Ordering note

Depending on the packaging requirement, the corresponding 4-digit packaging number is added to the 6-digit Cat. No.

ToR = packaging in the "Tape-on-Reel"
Tray = packaging in the "Tray"
Std = packaging in a "Standard box"

Example for ordering in the "Tape-on-Reel":

Poles	Type	Cat. No.	ToR	Tray	Std
2	SL-SMT 3.5/2/90	176177	4001

SL-SMT 3.5/90G pin headers

closed ends

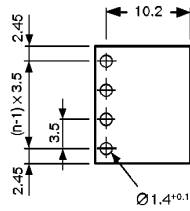
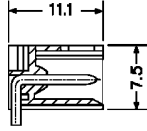

Pin length 1.5 mm
Colour

Poles	Type	Cat. No.	ToR	Tray	Std
2	SL-SMT 3.5/2/90G	176154	4001	o. r. ¹⁾	2001
3	SL-SMT 3.5/3/90G	176155	4001	o. r. ¹⁾	2001
4	SL-SMT 3.5/4/90G	176156	4001	3001	2001
5	SL-SMT 3.5/5/90G	176157	4001	3001	2001
6	SL-SMT 3.5/6/90G	176158	4001	3001	2001
7	SL-SMT 3.5/7/90G	176158	4001	3001	2001
8	SL-SMT 3.5/8/90G	176160	4001	3001	2001
9	SL-SMT 3.5/9/90G	176161	4001	3001	2001
10	SL-SMT 3.5/10/90G	176162	4001	3001	2001
11	SL-SMT 3.5/11/90G	176163	4001	3001	2001
12	SL-SMT 3.5/12/90G	176164	o. r. ¹⁾	3001	2001
13	SL-SMT 3.5/13/90G	176165	o. r. ¹⁾	3001	2001
14	SL-SMT 3.5/14/90G	176166	o. r. ¹⁾	3001	2001
15	SL-SMT 3.5/15/90G	176167	o. r. ¹⁾	3001	2001
16	SL-SMT 3.5/16/90G	176168	o. r. ¹⁾	3001	2001
17	SL-SMT 3.5/17/90G	176169	o. r. ¹⁾	3001	2001
18	SL-SMT 3.5/18/90G	176170	o. r. ¹⁾	3001	2001
19	SL-SMT 3.5/19/90G	176171	o. r. ¹⁾	3001	2001
20	SL-SMT 3.5/20/90G	176172	o. r. ¹⁾	3001	2001
21	SL-SMT 3.5/21/90G	176173	o. r. ¹⁾	3001	2001
22	SL-SMT 3.5/22/90G	176174	o. r. ¹⁾	3001	2001
23	SL-SMT 3.5/23/90G	176175	o. r. ¹⁾	3001	2001
24	SL-SMT 3.5/24/90G	176176	o. r. ¹⁾	3001	2001

1) on request

Description	Type	Cat. No.
Locking latch	BL/SL 3.5 VR OR	166931 0000
Coding element	BL/SL 3.50 KO OR	169343 0000
Light indicator	SL 3.5 FLA 1.5/8	159751 0000

SL-SMT 3.5/90F pin headers

flange version

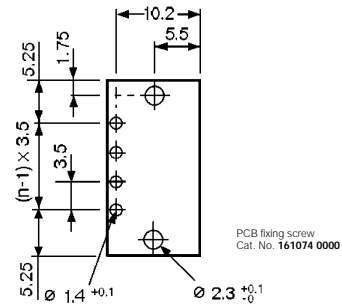
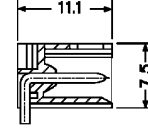

Pin length 1.5 mm
Colour

Poles	Type	Cat. No.	ToR	Tray	Std
2	SL-SMT 3.5/2/90F	176200	4001	3001	2001
3	SL-SMT 3.5/3/90F	176201	4001	3001	2001
4	SL-SMT 3.5/4/90F	176202	4001	3001	2001
5	SL-SMT 3.5/5/90F	176203	4001	3001	2001
6	SL-SMT 3.5/6/90F	176204	4001	3001	2001
7	SL-SMT 3.5/7/90F	176205	4001	3001	2001
8	SL-SMT 3.5/8/90F	176206	4001	3001	2001
9	SL-SMT 3.5/9/90F	176207	4001	3001	2001
10	SL-SMT 3.5/10/90F	176208	o. r. ¹⁾	3001	2001
11	SL-SMT 3.5/11/90F	176209	o. r. ¹⁾	3001	2001
12	SL-SMT 3.5/12/90F	176210	o. r. ¹⁾	3001	2001
13	SL-SMT 3.5/13/90F	176211	o. r. ¹⁾	3001	2001
14	SL-SMT 3.5/14/90F	176212	o. r. ¹⁾	3001	2001
15	SL-SMT 3.5/15/90F	176213	o. r. ¹⁾	3001	2001
16	SL-SMT 3.5/16/90F	176214	o. r. ¹⁾	3001	2001
17	SL-SMT 3.5/17/90F	176215	o. r. ¹⁾	3001	2001
18	SL-SMT 3.5/18/90F	176216	o. r. ¹⁾	3001	2001
19	SL-SMT 3.5/19/90F	176217	o. r. ¹⁾	3001	2001
20	SL-SMT 3.5/20/90F	176218	o. r. ¹⁾	3001	2001
21	SL-SMT 3.5/21/90F	176219	o. r. ¹⁾	3001	2001
22	SL-SMT 3.5/22/90F	176220	o. r. ¹⁾	3001	2001
23	SL-SMT 3.5/23/90F	176221	o. r. ¹⁾	3001	2001
24	SL-SMT 3.5/24/90F	176222	o. r. ¹⁾	3001	2001

1) on request

Description	Type	Cat. No.
Locking latch	BL/SL 3.5 VR OR	166931 0000
Coding element	BL/SL 3.50 KO OR	169343 0000
Light indicator	SL 3.5 FLA 1.5/8	159751 0000
PCB fixing screw	PTSC KA 22x4.5	161074 0000

SL-SMT 3.5/180 pin headers

open ends
attachable without loss of poles

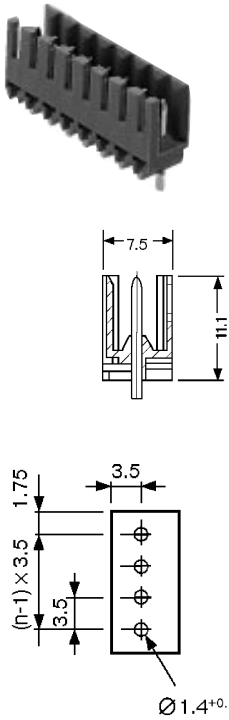

Pin length **1.5 mm**
Colour

Polzahl	Typ	Best.-Nr.	ToR	Tray	Std
2	SL-SMT 3.5/2/180	176073	4001	o. r. ¹⁾	2001
3	SL-SMT 3.5/3/180	176074	4001	o. r. ¹⁾	2001
4	SL-SMT 3.5/4/180	176075	4001	3001	2001
5	SL-SMT 3.5/5/180	176076	4001	3001	2001
6	SL-SMT 3.5/6/180	176077	4001	3001	2001
7	SL-SMT 3.5/7/180	176078	4001	3001	2001
8	SL-SMT 3.5/8/180	176079	4001	3001	2001
9	SL-SMT 3.5/9/180	176080	4001	3001	2001
10	SL-SMT 3.5/10/180	176081	4001	3001	2001
11	SL-SMT 3.5/11/180	176082	4001	3001	2001
12	SL-SMT 3.5/12/180	176083	o. r. ¹⁾	3001	2001
13	SL-SMT 3.5/13/180	176084	o. r. ¹⁾	3001	2001
14	SL-SMT 3.5/14/180	176085	o. r. ¹⁾	3001	2001
15	SL-SMT 3.5/15/180	176086	o. r. ¹⁾	3001	2001
16	SL-SMT 3.5/16/180	176087	o. r. ¹⁾	3001	2001
17	SL-SMT 3.5/17/180	176088	o. r. ¹⁾	3001	2001
18	SL-SMT 3.5/18/180	176089	o. r. ¹⁾	3001	2001
19	SL-SMT 3.5/19/180	176090	o. r. ¹⁾	3001	2001
20	SL-SMT 3.5/20/180	176091	o. r. ¹⁾	3001	2001
21	SL-SMT 3.5/21/180	176092	o. r. ¹⁾	3001	2001
22	SL-SMT 3.5/22/180	176093	o. r. ¹⁾	3001	2001
23	SL-SMT 3.5/23/180	176094	o. r. ¹⁾	3001	2001
24	SL-SMT 3.5/24/180	176095	o. r. ¹⁾	3001	2001

1) on request

SL-SMT 3.5/9180G pin headers

closed ends

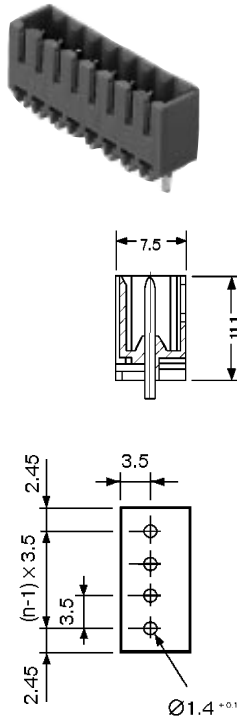

Pin length **1.5 mm**
Colour

Polzahl	Typ	Best.-Nr.	ToR	Tray	Std
2	SL-SMT 3.5/2/180G	175298	4001	o. r. ¹⁾	2001
3	SL-SMT 3.5/3/180G	175299	4001	o. r. ¹⁾	2001
4	SL-SMT 3.5/4/180G	175300	4001	3001	2001
5	SL-SMT 3.5/5/180G	175301	4001	3001	2001
6	SL-SMT 3.5/6/180G	175302	4001	3001	2001
7	SL-SMT 3.5/7/180G	175303	4001	3001	2001
8	SL-SMT 3.5/8/180G	175304	4001	3001	2001
9	SL-SMT 3.5/9/180G	175305	4001	3001	2001
10	SL-SMT 3.5/10/180G	175306	4001	3001	2001
11	SL-SMT 3.5/11/180G	175307	4001	3001	2001
12	SL-SMT 3.5/12/180G	175308	o. r. ¹⁾	3001	2001
13	SL-SMT 3.5/13/180G	175309	o. r. ¹⁾	3001	2001
14	SL-SMT 3.5/14/180G	175310	o. r. ¹⁾	3001	2001
15	SL-SMT 3.5/15/180G	175311	o. r. ¹⁾	3001	2001
16	SL-SMT 3.5/16/180G	175312	o. r. ¹⁾	3001	2001
17	SL-SMT 3.5/17/180G	175313	o. r. ¹⁾	3001	2001
18	SL-SMT 3.5/18/180G	175314	o. r. ¹⁾	3001	2001
19	SL-SMT 3.5/19/180G	175315	o. r. ¹⁾	3001	2001
20	SL-SMT 3.5/20/180G	175316	o. r. ¹⁾	3001	2001
21	SL-SMT 3.5/21/180G	175317	o. r. ¹⁾	3001	2001
22	SL-SMT 3.5/22/180G	175318	o. r. ¹⁾	3001	2001
23	SL-SMT 3.5/23/180G	175319	o. r. ¹⁾	3001	2001
24	SL-SMT 3.5/24/180G	175320	o. r. ¹⁾	3001	2001

1) on request

SL-SMT 3.5/180F pin headers

flange versions

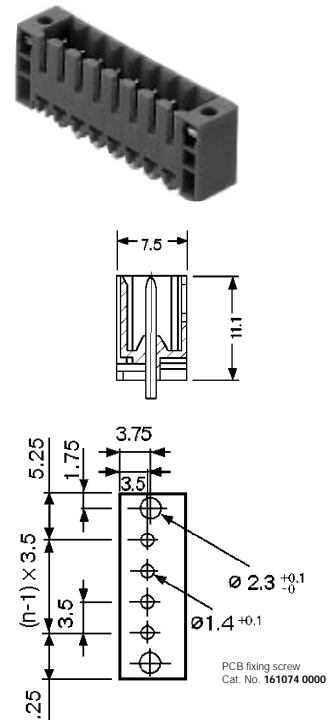

Pin length **1.5 mm**
Colour

Polzahl	Typ	Best.-Nr.	ToR	Tray	Std
2	SL-SMT 3.5/2/180F	176096	4001	3001	2001
3	SL-SMT 3.5/3/180F	176097	4001	3001	2001
4	SL-SMT 3.5/4/180F	176098	4001	3001	2001
5	SL-SMT 3.5/5/180F	176099	4001	3001	2001
6	SL-SMT 3.5/6/180F	176100	4001	3001	2001
7	SL-SMT 3.5/7/180F	176101	4001	3001	2001
8	SL-SMT 3.5/8/180F	176102	4001	3001	2001
9	SL-SMT 3.5/9/180F	176103	4001	3001	2001
10	SL-SMT 3.5/10/180F	176104	o. r. ¹⁾	3001	2001
11	SL-SMT 3.5/11/180F	176105	o. r. ¹⁾	3001	2001
12	SL-SMT 3.5/12/180F	176106	o. r. ¹⁾	3001	2001
13	SL-SMT 3.5/13/180F	176107	o. r. ¹⁾	3001	2001
14	SL-SMT 3.5/14/180F	176108	o. r. ¹⁾	3001	2001
15	SL-SMT 3.5/15/180F	176109	o. r. ¹⁾	3001	2001
16	SL-SMT 3.5/16/180F	176110	o. r. ¹⁾	3001	2001
17	SL-SMT 3.5/17/180F	176111	o. r. ¹⁾	3001	2001
18	SL-SMT 3.5/18/180F	176112	o. r. ¹⁾	3001	2001
19	SL-SMT 3.5/19/180F	176113	o. r. ¹⁾	3001	2001
20	SL-SMT 3.5/20/180F	176114	o. r. ¹⁾	3001	2001
21	SL-SMT 3.5/21/180F	176115	o. r. ¹⁾	3001	2001
22	SL-SMT 3.5/22/180F	176116	o. r. ¹⁾	3001	2001
23	SL-SMT 3.5/23/180F	176117	o. r. ¹⁾	3001	2001
24	SL-SMT 3.5/24/180F	176118	o. r. ¹⁾	3001	2001

1) on request

Accessories

Description	Type	Cat. No.
Locking latch	BL/SL 3.5 VR OR	166931 0000
Coding element	BL/SL 3.50 KO OR	169343 0000
Light indicator	SL 3.5 FLA 1.5/8	159751 0000

Description	Type	Cat. No.
Locking latch	BL/SL 3.5 VR OR	166931 0000
Coding element	BL/SL 3.50 KO OR	169343 0000
Light indicator	SL 3.5 FLA 1.5/8	159751 0000

Description	Type	Cat. No.
Locking latch	BL/SL 3.5 VR OR	166931 0000
Coding element	BL/SL 3.50 KO OR	169343 0000
Light indicator	SL 3.5 FLA 1.5/8	159751 0000
PCB fixing screw	PTSC KA 22x4.5	161074 0000

Ordering note

Depending on the packaging requirement, the corresponding 4-digit packaging number is added to the 6-digit Cat. No.

ToR = packaging in the "Tape-on-Reel"
Tray = packaging in the "Tray"
Std = packaging in a "Standard box"

Example for ordering in the "Tape-on-Reel":

Poles	Type	Cat. No.	ToR	Tray	Std
2	SL-SMT 3.5/2/180	176177	4001

Example for ordering in the "Tray":

Poles	Type	Cat. No.	ToR	Tray	Std
2	SL-SMT 3.5/2/90	176177	...	3001	...

Example for ordering in a "Standard box":

Poles	Type	Cat. No.	ToR	Tray	Std
2	SL-SMT 3.5/2/90	176177	2001

Design recommendation

We recommend design and calculation of the holes and soldering pastes as follows to ensure an optimum soldering result in the component placement and reflow processes:

- Large fitting hole of the printed circuit board (final diameter) for automatic placement:

Ø 1.4^{+0.1} mm

This fitting hole is recommended to be able to compensate for printed circuit board, component and machine tolerances.

- Small soldering eyelets:

Ø 2.3 mm

Small soldering eyelets to ensure that as much soldering paste as possible flows into the through-plating (fitting) hole.

Soldering paste calculation

The quantity of soldering paste depends on:

- pcb thickness
- diameter (Ø) of the pcb's fitting hole
- soldering pin volume in the pcb
- soldering paste evaporation
- desired soldered joint shape

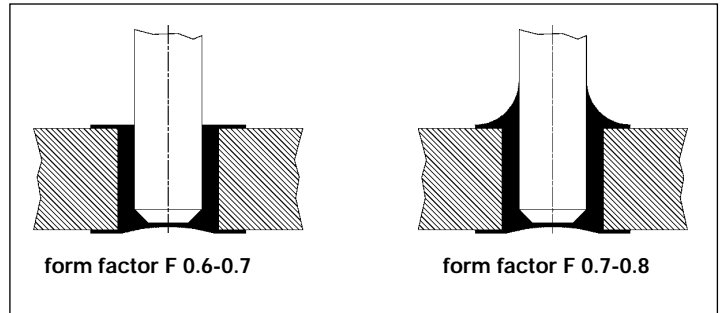

Calculation example:

$$\begin{aligned}
 V_{\text{soldering pin}} &= 1.34 \text{ mm}^3 \\
 V_{\text{fitting hole}} &= \frac{(\text{Ø fitting hole})^2 * \pi * \text{pcb thickness}}{4} = \frac{(1.4 \text{ mm})^2 * \pi * 1.6 \text{ mm}}{4} = 2.46 \text{ mm}^3 \\
 V_{\text{soldered joint volume}} &= V_{\text{fitting hole}} - V_{\text{soldering pin}} = 2.46 \text{ mm}^3 - 1.34 \text{ mm}^3 = 1.12 \text{ mm}^3 \\
 V_{\text{soldering paste volume}} &= V_{\text{soldering paste volume}} * 2^{1)} = 1.12 \text{ mm}^3 * 2 = 2.24 \text{ mm}^3
 \end{aligned}$$

¹⁾ Factor 2 applies only to soldering pastes with a 50% evaporation volume. Adapt this value to other soldering pastes.

Stencil calculation

The stencil surface calculation depends on:

- stencil thickness
- soldering paste volume
- soldered joint shape

Calculation example:

$$\begin{aligned}
 A_{\text{stencil hole surface}} &= \frac{V_{\text{soldering paste volume}}}{\text{stencil thickness}} = \frac{2.24 \text{ mm}^3}{0.18 \text{ mm}} = 12.44 \text{ mm}^2 \\
 D_{\text{stencil hole-Ø}} &= \left(A_{\text{stencil hole surface}} * \frac{4}{\pi} \right)^{0.5} * 0.7^{2)} = \left(12.44 \text{ mm} * \frac{4}{\pi} \right)^{0.5} * 0.7 = 2.79 \text{ mm}
 \end{aligned}$$

²⁾ The soldered joint form factor for the soldered joint shape recommended by us is 0.7

Important: the maximum diameter of the stencil hole should not exceed 2.8 mm (risk for solder beads forming).

For the soldered joint shape and diameter that we recommend, with a stencil thickness of 0.18 mm and a printed circuit board thickness of 1.6 mm, this results in a stencil hole of 2.8 mm (see calculation example).