

### Features

- High Breakdown Voltage
- Low Turn-on Voltage
- Guard Ring Construction for Transient Protection
- **Lead, Halogen and Antimony Free, RoHS Compliant "Green" Device (Notes 4 and 5)**

### Mechanical Data

- Case: SOD-123
- Case Material: Molded Plastic. UL Flammability Classification Rating 94V-0
- Moisture Sensitivity: Level 1 per J-STD-020D
- Terminals: Solderable per MIL-STD-202, Method 208
- Lead Free Plating (Matte Tin Finish annealed over Alloy 42 leadframe)
- Polarity: Cathode Band
- Marking Information: See Page 3
- Ordering Information: See Page 3
- Weight: 0.01 grams (approximate)



Top View

### Maximum Ratings @T<sub>A</sub> = 25°C unless otherwise specified

Characteristic	Symbol	Value	Unit
Peak Repetitive Reverse Voltage	V <sub>RRM</sub>	100	V
Working Peak Reverse Voltage	V <sub>RWM</sub>		
DC Blocking Voltage	V <sub>R</sub>		
Forward Continuous Current (See figure 4)	I <sub>F</sub>	150	mA
Repetitive Peak Forward Current (Note 1) @ t <sub>p</sub> < 1.0s, Duty Cycle < 50%	I <sub>FRM</sub>	350	mA
Forward Surge Forward Current (Note 1) @ t <sub>p</sub> = 10ms	I <sub>FSM</sub>	750	mA

### Thermal Characteristics

Characteristic	Symbol	Value	Unit
Power Dissipation	P <sub>D</sub>	200	mW
Thermal Resistance, Junction to Ambient Air (Note 1)	R <sub>θJA</sub>	420	°C/W
Thermal Resistance, Junction to Ambient Air (Note 2)		370	
Operating Temperature Range	T <sub>J</sub>	-55 to +125	°C
Storage Temperature Range	T <sub>STG</sub>	-55 to +150	°C

### Electrical Characteristics @T<sub>A</sub> = 25°C unless otherwise specified

Characteristic	Symbol	Min	Typ	Max	Unit	Test Condition
Reverse Breakdown Voltage (Note 3)	V <sub>(BR)R</sub>	100	—	—	V	I <sub>R</sub> = 100μA
Forward Voltage	V <sub>F</sub>	—	—	0.25 0.45 1.00	V	I <sub>F</sub> = 0.1mA I <sub>F</sub> = 10mA I <sub>F</sub> = 250mA
Peak Reverse Current (Note 3)	I <sub>R</sub>	—	—	0.3 5.0 0.5 7.5 1.0 15 2.0 20	μA	V <sub>R</sub> = 1.5V V <sub>R</sub> = 1.5V, T <sub>J</sub> = 60°C V <sub>R</sub> = 10V V <sub>R</sub> = 10V, T <sub>J</sub> = 60°C V <sub>R</sub> = 50V V <sub>R</sub> = 50V, T <sub>J</sub> = 60°C V <sub>R</sub> = 75V V <sub>R</sub> = 75V, T <sub>J</sub> = 60°C
Total Capacitance	C <sub>T</sub>	—	20 12	—	pF	V <sub>R</sub> = 0V, f = 1.0MHz V <sub>R</sub> = 1.0V, f = 1.0MHz

- Notes:
1. Part mounted on FR-4 board with recommended pad layout, which can be found on our website at <http://www.diodes.com/datasheets/ap02001.pdf>.
  2. Part mounted on Polyimide board with recommended pad layout, which can be found on our website at <http://www.diodes.com/datasheets/ap02001.pdf>.
  3. Short duration pulse test used to minimize self-heating effect.
  4. No purposefully added lead. Halogen and Antimony Free.
  5. Product manufactured with Data Code V9 (week 33, 2008) and newer are built with Green Molding Compound. Product manufactured prior to Date Code V9 are built with Non-Green Molding Compound and may contain Halogens or Sb<sub>2</sub>O<sub>3</sub> Fire Retardants.

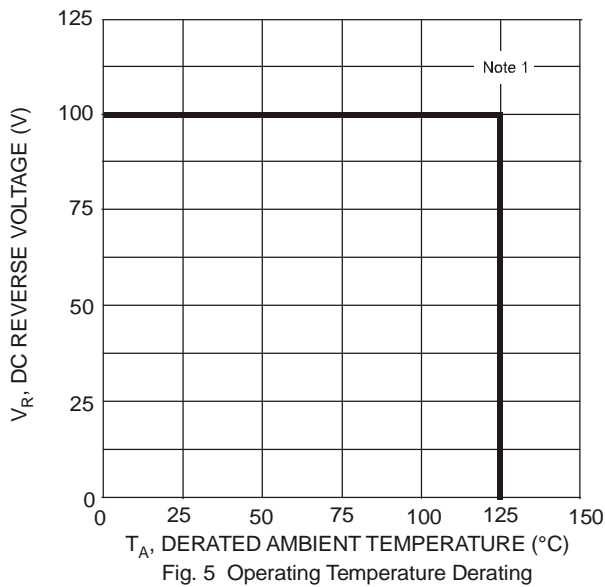
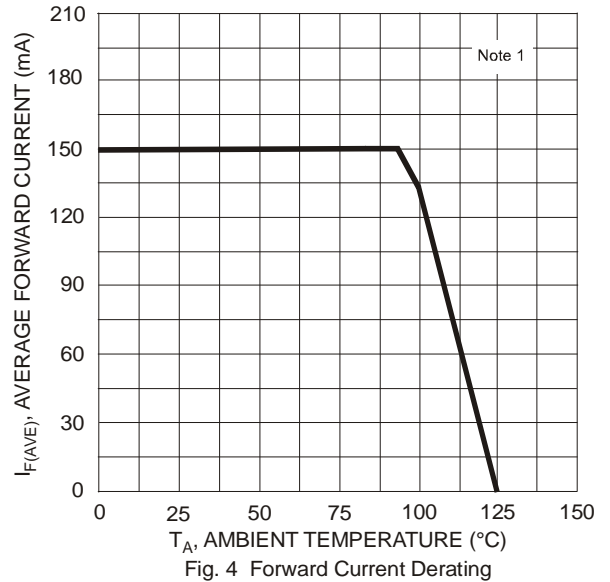
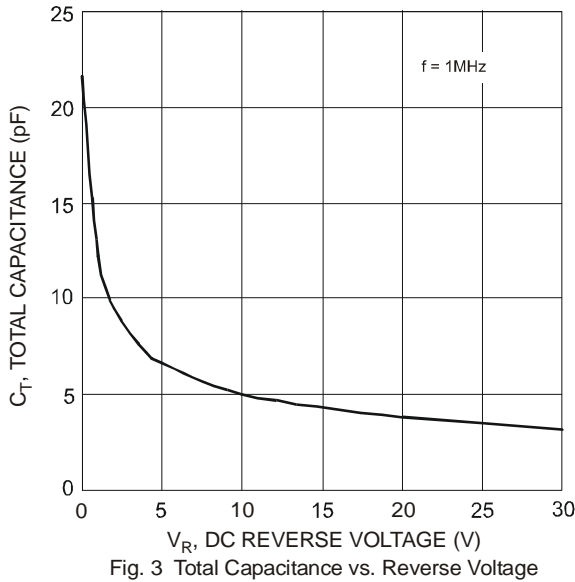
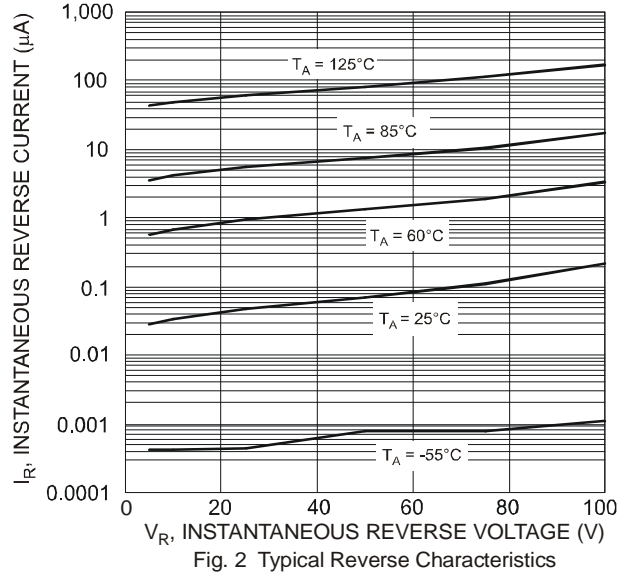
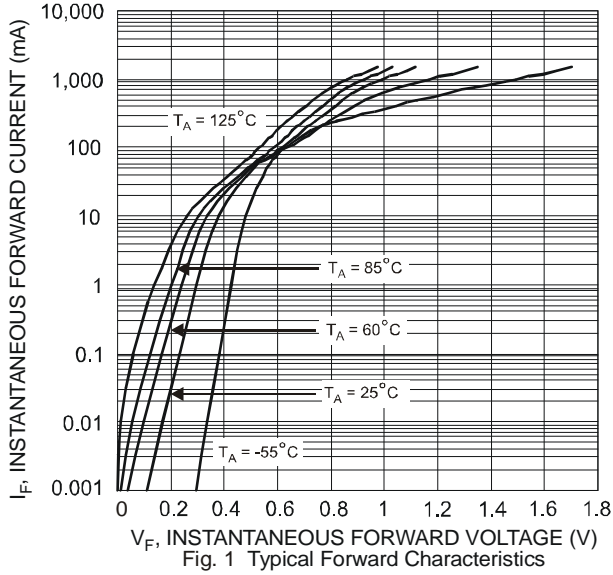

### Ordering Information (Note 6)

Part Number	Case	Packaging
BAT46W-7-F	SOD-123	3000/Tape & Reel

Notes: 6. For packaging details, go to our website at <http://www.diodes.com/datasheets/ap02007.pdf>.

### Marking Information

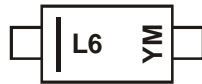

L6 = Product Type Marking Code  
 YM = Date Code Marking  
 Y = Year (ex: S = 2005)  
 M = Month (ex: 9 = September)

#### Date Code Key

Year	2004	2005	2006	2007	2008	2009	2010	2011	2012	2013	2014	2015
Code	R	S	T	U	V	W	X	Y	Z	A	B	C

Month	Jan	Feb	Mar	Apr	May	Jun	Jul	Aug	Sep	Oct	Nov	Dec
Code	1	2	3	4	5	6	7	8	9	O	N	D

### Package Outline Dimensions

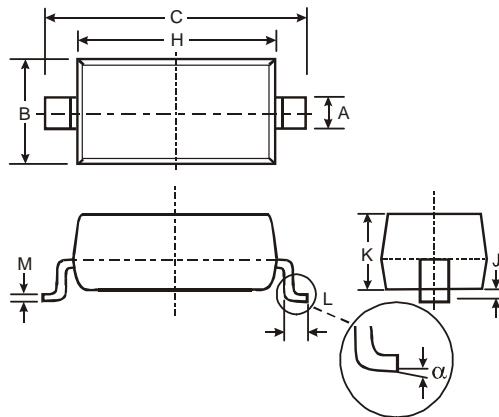

SOD-123		
Dim	Min	Max
A	0.55 Typ	
B	1.40	1.70
C	3.55	3.85
H	2.55	2.85
J	0.00	0.10
K	1.00	1.35
L	0.25	0.40
M	0.10	0.15
$\alpha$	0	8°
All Dimensions in mm		

### Suggested Pad Layout

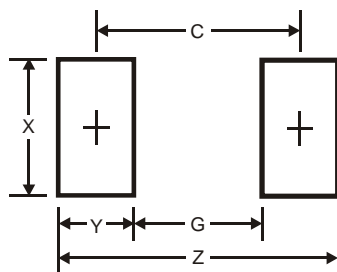

Dimensions	Value (in mm)
Z	4.9
G	2.5
X	0.7
Y	1.2
C	3.7

#### IMPORTANT NOTICE

Diodes Incorporated and its subsidiaries reserve the right to make modifications, enhancements, improvements, corrections or other changes without further notice to any product herein. Diodes Incorporated does not assume any liability arising out of the application or use of any product described herein; neither does it convey any license under its patent rights, nor the rights of others. The user of products in such applications shall assume all risks of such use and will agree to hold Diodes Incorporated and all the companies whose products are represented on our website, harmless against all damages.

#### LIFE SUPPORT

Diodes Incorporated products are not authorized for use as critical components in life support devices or systems without the expressed written approval of the President of Diodes Incorporated.