

6 AMP GENERAL PURPOSE SILICON DIODES

FEATURES

- Low cost
- Low leakage
- Low forward voltage drop
- High current capacity
- Easily cleaned with freon, alcohol, chloroethene and similar solvents

RoHS COMPLIANT

MECHANICAL DATA

- Case: Molded epoxy (U/L Flammability Rating 94V-0)
- Terminals: Plated axial leads
- Soldering: Per MIL-STD 202 Method 208 guaranteed
- Polarity: Color band denotes cathode
- Mounting Position: Any
- Weight: 0.07 Ounces (2.1 Grams)

MECHANICAL SPECIFICATION

ACTUAL SIZE OF
GP600 PACKAGE

SERIES GP600 - GP110

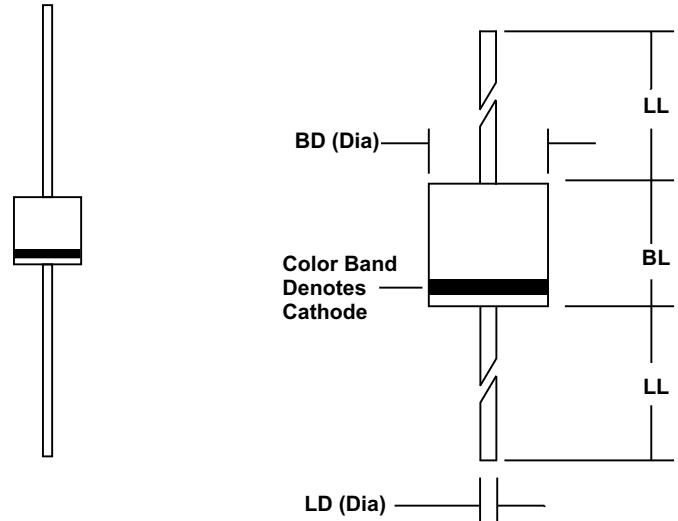

Sym	Minimum		Maximum	
	In	mm	In	mm
BL	0.340	8.6	0.360	9.1
BD	0.340	8.6	0.360	9.1
LL	1.00	25.4		
LD	0.048	1.2	0.052	1.3

MAXIMUM RATINGS & ELECTRICAL CHARACTERISTICS

Ratings at 25 °C ambient temperature unless otherwise specified.
 Single phase, half wave, 60Hz, resistive or inductive load.
 For capacitive loads, derate current by 20%.

PARAMETER (TEST CONDITIONS)	SYMBOL	RATINGS							UNITS
		GP600	GP601	GP602	GP604	GP606	GP608	GP610	
Series Number									
Maximum DC Blocking Voltage	V _{RM}	50	100	200	400	600	800	1000	VOLTS
Maximum RMS Voltage	V _{RMS}	35	70	140	280	420	560	700	
Maximum Peak Recurrent Reverse Voltage	V _{RRM}	50	100	200	400	600	800	1000	
Average Forward Rectified Current @ T _A = 60 °C, Lead length = 0.375 in. (9.5 mm)	I _O	6							AMPS
Peak Forward Surge Current (8.3 mSec single half sine wave superimposed on rated load)	I _{FSM}	400							
Maximum Forward Voltage at 6 Amps DC	V _{FM}	1							VOLTS
Maximum Full Cycle Reverse Current @ T _L = 75 °C (Note 1)	I _{RM(AV)}	25							μA
Maximum Average DC Reverse Current At Rated DC Blocking Voltage	I _{RM}	10 100							
Typical Thermal Resistance, Junction to Ambient (Note 1)	R _{θJA}	10							°C/W
Typical Junction Capacitance (Note 2)	C _J	100							pF
Operating and Storage Temperature Range	T _J , T _{STG}	-65 to +175							°C

NOTES: (1) Lead length = 0.375 in. (9.5 mm)
 (2) Measured at 1MHz & applied reverse voltage of 4 volts

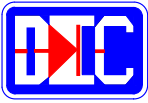

6 AMP GENERAL PURPOSE SILICON DIODES

RATING & CHARACTERISTIC CURVES FOR SERIES GP600 - GP610

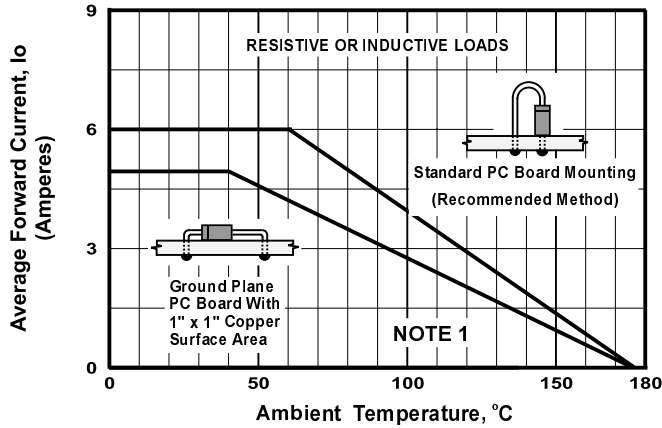

FIGURE 1. FORWARD CURRENT DERATING CURVE

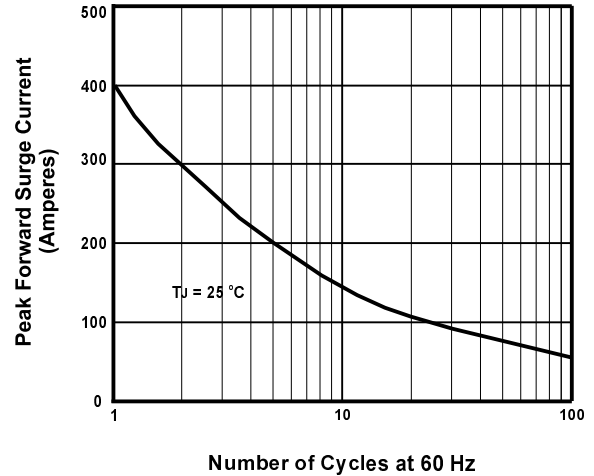

FIGURE 2. MAXIMUM NON-REPETITIVE SURGE CURRENT

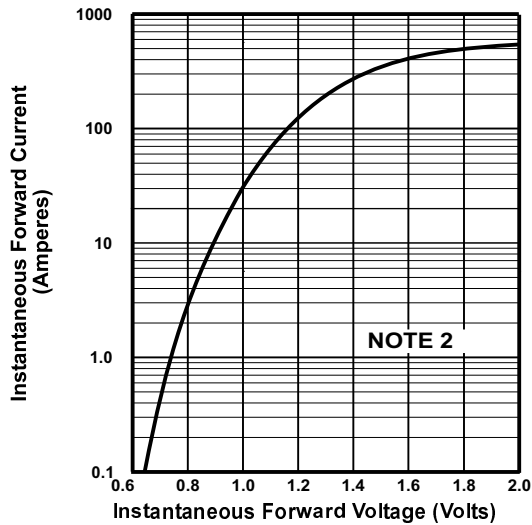

FIGURE 3. TYPICAL FORWARD CHARACTERISTICS

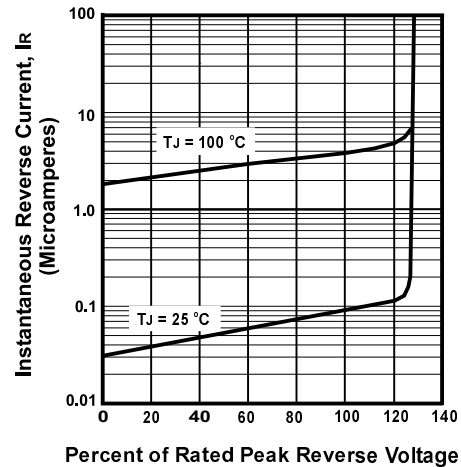

FIGURE 4. TYPICAL REVERSE CHARACTERISTICS

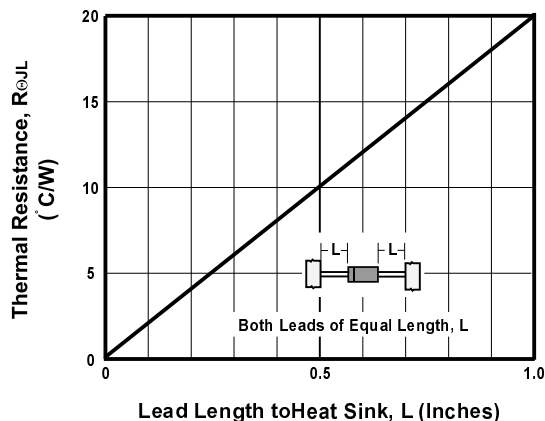

FIGURE 5. TYPICAL THERMAL RESISTANCE

NOTES

- (1) Single Phase, Half Wave, 60 Hz
- (2) $T_J = 25\text{ }^\circ\text{C}$, Pulse Width = 300 μSec , 1.0% Duty Cycle