

PSRAM

2-Mbit (256K x 8)

Pseudo Static RAM

Features

- Advanced low-power architecture
- High speed: 55 ns, 70 ns
- Wide voltage range: 2.7V to 3.3V
- Typical active current: 1 mA @ f = 1 MHz
- Low standby power
- Automatic power-down when deselected

Functional Description

The M24L28256DA is a high-performance CMOS pseudo static RAM (PSRAM) organized as 256K words by 8 bits. Easy memory expansion is provided by an active LOW Chip Enable (\overline{CE}_1) and active HIGH Chip Enable (\overline{CE}_2), and active LOW Output Enable (\overline{OE}). This device has an automatic power-down feature that reduces power consumption dramatically when deselected. Writing to the device is accomplished by asserting Chip Enable One (\overline{CE}_1) and Write

Enable (\overline{WE}) inputs LOW and Chip Enable Two (\overline{CE}_2) input HIGH. Data on the eight I/O pins (I/O_0 through I/O_7) is then written into the location specified on the address pins (A_0 through A_{17}).

Reading from the device is accomplished by asserting the Chip Enable One (\overline{CE}_1) and Output Enable (\overline{OE}) inputs LOW while forcing Write Enable (\overline{WE}) HIGH. And Chip Enable Two (\overline{CE}_2) HIGH. Under these conditions, the contents of the memory location specified by the address pins will appear on the I/O pins.

The eight input/output pins (I/O_0 through I/O_7) are placed in a high-impedance state when the device is deselected (\overline{CE}_1 HIGH or \overline{CE}_2 LOW), the outputs are disabled (\overline{OE} HIGH), or during write operation (\overline{CE}_1 LOW, \overline{CE}_2 HIGH, and \overline{WE} LOW). See the Truth Table for a complete description of read and write modes.

Logic Block Diagram

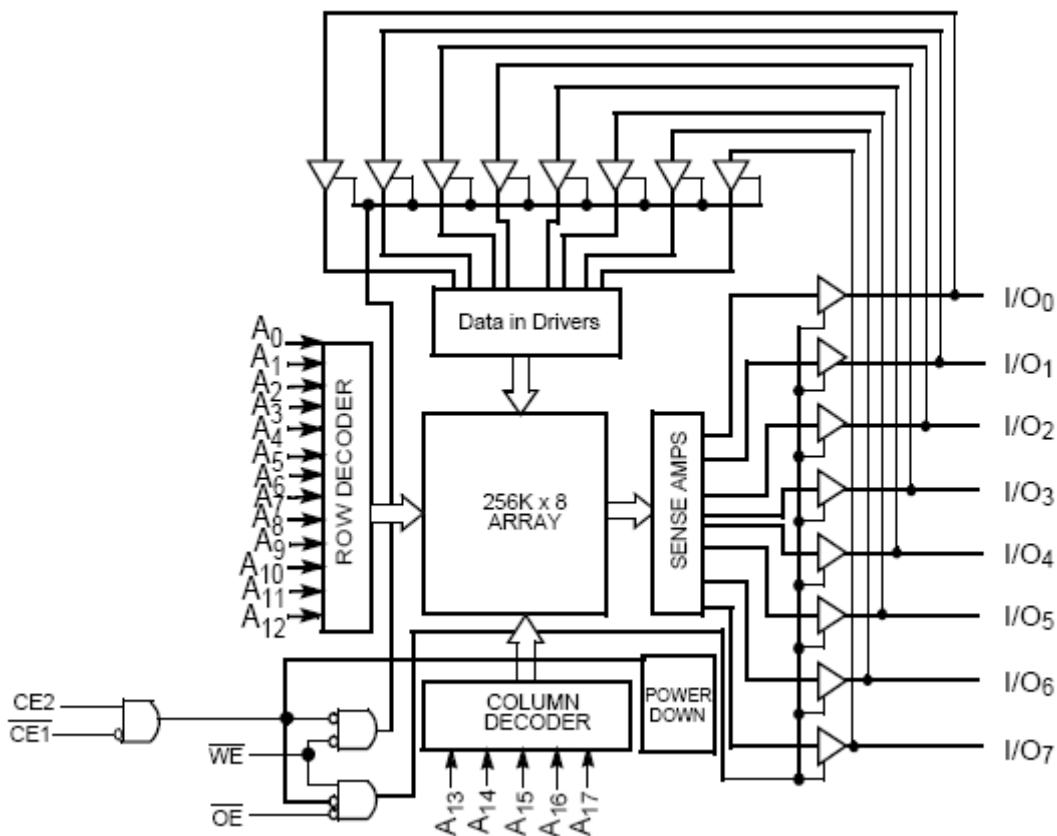

Pin Configuration[1]

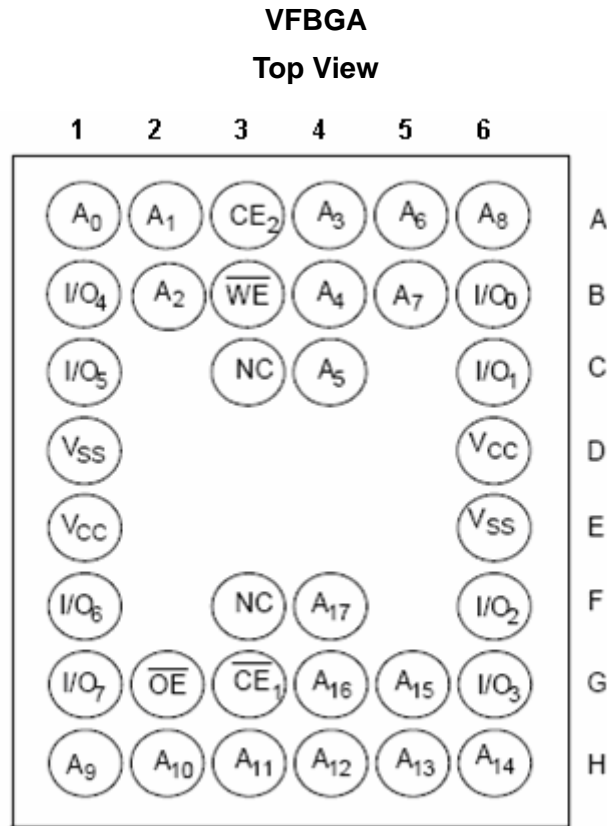

Product Portfolio

Product	V _{CC} Range (V)			Speed(ns)	Power Dissipation					
					Operating I _{CC} (mA)				Standby I _{SB2} (μA)	
	f = 1MHz		f = f _{MAX}							
	Min.	Typ.	Max.		Typ.[2]	Max.	Typ.[2]	Max.	Typ. [2]	Max.
M24L28256DA	2.7	3.0	3.3	55	1	5	14	22	9	40
				70			8	15		

Notes:

1. NC “no connect”—not connected internally to the die.
2. Typical values are included for reference only and are not guaranteed or tested. Typical values are measured at V_{CC} = V_{CC(typ)} and T_A = 25°C.

Maximum Ratings

(Above which the useful life may be impaired. For user guide-lines, not tested.)
 Storage Temperature-65°C to +150°C
 Ambient Temperature with Power Applied-40°C to +85°C
 Supply Voltage to Ground Potential-0.4V to 4.6V
 DC Voltage Applied to Outputs in High-Z State[3, 4, 5]-0.4V to 3.7V
 DC Input Voltage[3, 4, 5].....-0.4V to 3.7V
 Output Current into Outputs (LOW)20 mA

Static Discharge Voltage >2001V (per MIL-STD-883, Method 3015)
 Latch-up Current> 200 mA

Operating Range

Range	Ambient Temperature (T _A)	V _{CC}
Extended	-25°C to +85°C	2.7V to 3.3V

Electrical Characteristics (Over the Operating Range)

Parameter	Description	Test Conditions	-55			-70			Unit
			Min.	Typ. [2]	Max.	Min.	Typ. [2]	Max.	
V _{CC}	Supply Voltage		2.7	3.0	3.3	2.7		3.3	V
V _{OH}	Output HIGH Voltage	I _{OH} = -0.1 mA	V _{CC} -0.4			V _{CC} -0.4			V
V _{OL}	Output LOW Voltage	I _{OL} = 0.1 mA			0.4			0.4	V
V _{IH}	Input HIGH Voltage		0.8* V _{CC}		V _{CC} +0.4	0.8* V _{CC}		V _{CC} +0.4	V
V _{IL}	Input LOW Voltage		-0.4		0.4	-0.4		0.4	V
I _{Ix}	Input Leakage Current	GND ≤ V _{IN} ≤ V _{CC}	-1		+1	-1		+1	μA
I _{OZ}	Output Leakage Current	GND ≤ V _{OUT} ≤ V _{CC} , Output Disable	-1		+1	-1		+1	μA
I _{CC}	V _{CC} Operating Supply Current	f = f _{MAX} = 1/t _{RC}		14	22		8	15	mA
		f = 1 MHz		1	5		1	5	
I _{SB1}	Automatic \overline{CE}_1 Power-Down Current —CMOS Inputs	$\overline{CE}_1 \geq V_{CC}-0.2V, CE_2 \leq 0.2V$ V _{IN} ≥ V _{CC} - 0.2V, V _{IN} ≤ 0.2V, f = f _{MAX} (Address and Data Only), f = 0		40	250		40	250	μA
I _{SB2}	Automatic \overline{CE}_1 Power-Down Current —CMOS Inputs	$\overline{CE}_1 \geq V_{CC}-0.2V, CE_2 \leq 0.2V$ V _{IN} ≥ V _{CC} - 0.2V, V _{IN} ≤ 0.2V, f = 0, V _{CC} = 3.3V		9	40		9	40	μA

Capacitance[6]

Parameter	Description	Test Conditions	Max.	Unit
C _{IN}	Input Capacitance	TA = 25°C, f = 1 MHz	8	pF
C _{OUT}	Output Capacitance	V _{CC} = V _{CC(typ)}	8	pF

Thermal Resistance[6]

Parameter	Description	Test Conditions	BGA	Unit
θ _{JA}	Thermal Resistance(Junction to Ambient)	Test conditions follow standard test methods and procedures for measuring thermal impedance, per EIA/ JESD51.	55	°C/W
θ _{JC}	Thermal Resistance (Junction to Case)		17	°C/W

Notes:

- 3.V_{IH(MAX)} = V_{CC} + 0.5V for pulse durations less than 20 ns.
- 4.V_{IL(MIN)} = -0.5V for pulse durations less than 20 ns.
- 5.Overshoot and undershoot specifications are characterized and are not 100% tested.
- 6.Tested initially and after design or process changes that may affect these parameters.

AC Test Loads and Waveforms

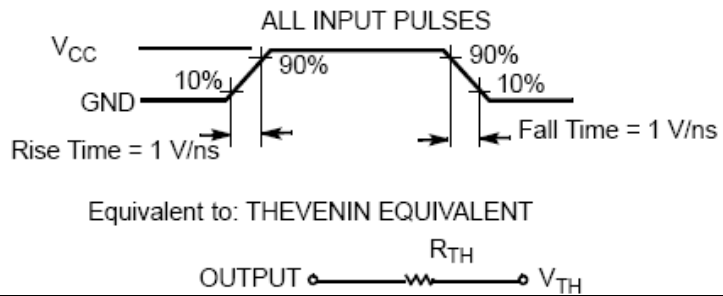
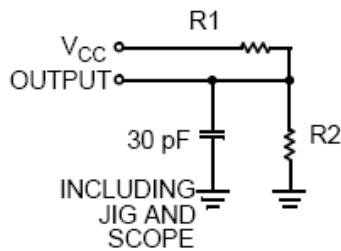

Parameters	3.0V (V _{CC})	Unit
R1	22000	Ω
R2	22000	Ω
R _{TH}	11000	Ω
V _{TH}	1.50	V

Switching Characteristics (Over the Operating Range) [7]

Parameter	Description	-55		-70		Unit
		Min.	Max.	Min.	Max.	
Read Cycle						
t _{RC}	Read Cycle Time	55[11]		70		ns
t _{AA}	Address to Data Valid		55		70	ns
t _{OHA}	Data Hold from Address Change	5		10		ns
t _{ACE}	\overline{CE}_1 LOW and CE ₂ HIGH to Data Valid		55		70	ns
t _{DOE}	\overline{OE} LOW to Data Valid		25		35	ns
t _{LZOE}	\overline{OE} LOW to Low Z[8, 9]	5		5		ns
t _{HZOE}	\overline{OE} HIGH to High Z[8, 9]		25		25	ns
t _{LZCE}	\overline{CE}_1 LOW and CE ₂ HIGH to LOW Z[8, 9]	5		5		ns
t _{HZCE}	\overline{CE}_1 HIGH and CE ₂ LOW to HIGH Z[8, 9]		25		25	ns
t _{SK[11]}	Address Skew		0		10	ns
Write Cycle [10]						
t _{WC}	Write Cycle Time	55		70		ns
t _{SCE}	\overline{CE}_1 LOW and CE ₂ HIGH to Write End	45		55		ns
t _{AW}	Address Set-Up to Write End	45		55		ns
t _{HA}	Address Hold from Write End	0		0		ns
t _{SA}	Address Set-Up to Write Start	0		0		ns
t _{PWE}	\overline{WE} Pulse Width	40		55		ns
t _{SD}	Data Set-Up to Write End	25		25		ns
t _{HD}	Data Hold from Write End	0		0		ns
t _{HZWE}	\overline{WE} LOW to High-Z[8, 9]		25		25	ns
t _{LZWE}	\overline{WE} HIGH to Low-Z[8, 9]	5		5		ns

Notes:

- Test conditions assume signal transition time of 1V/ns or higher, timing reference levels of V_{CC(typ)}/2, input pulse levels of 0V to V_{CC(typ)}, and output loading of the specified I_{OL}/I_{OH} and 30-pF load capacitance
- t_{HZOE}, t_{HZCE}, and t_{HZWE} transitions are measured when the outputs enter a high-impedance state.
- High-Z and Low-Z parameters are characterized and are not 100% tested.
- The internal write time of the memory is defined by the overlap of \overline{WE} , $\overline{CE}_1 = V_{IL}$, and CE₂=V_{IH}. All signals must be ACTIVE to initiate a write and any of these signals can terminate a write by going INACTIVE. The data input set-up and hold timing should be referenced to the edge of the signal that terminates write.
- To achieve 55-ns performance, the read access should be \overline{CE} controlled. In this case t_{ACE} is the critical parameter and t_{SK} is satisfied when the addresses are stable prior to chip enable going active. For the 70-ns cycle, the addresses must be stable within 10 ns after the start of the read cycle.

Switching Waveforms

Read Cycle 1 (Address Transition Controlled)[11, 12, 13]

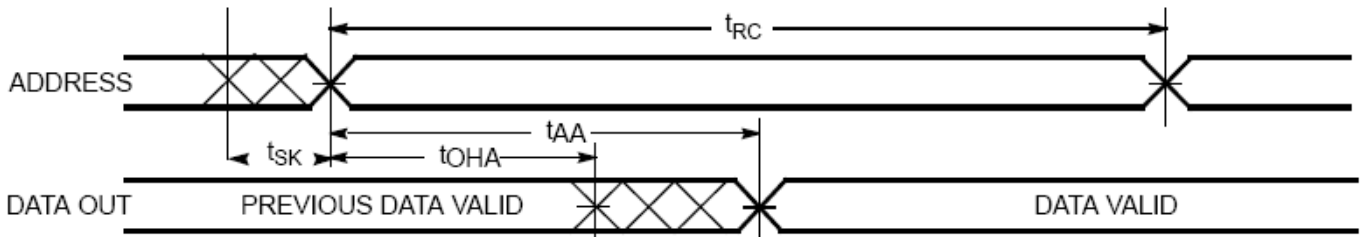

Read Cycle 2 (\overline{OE} Controlled)[11, 13]

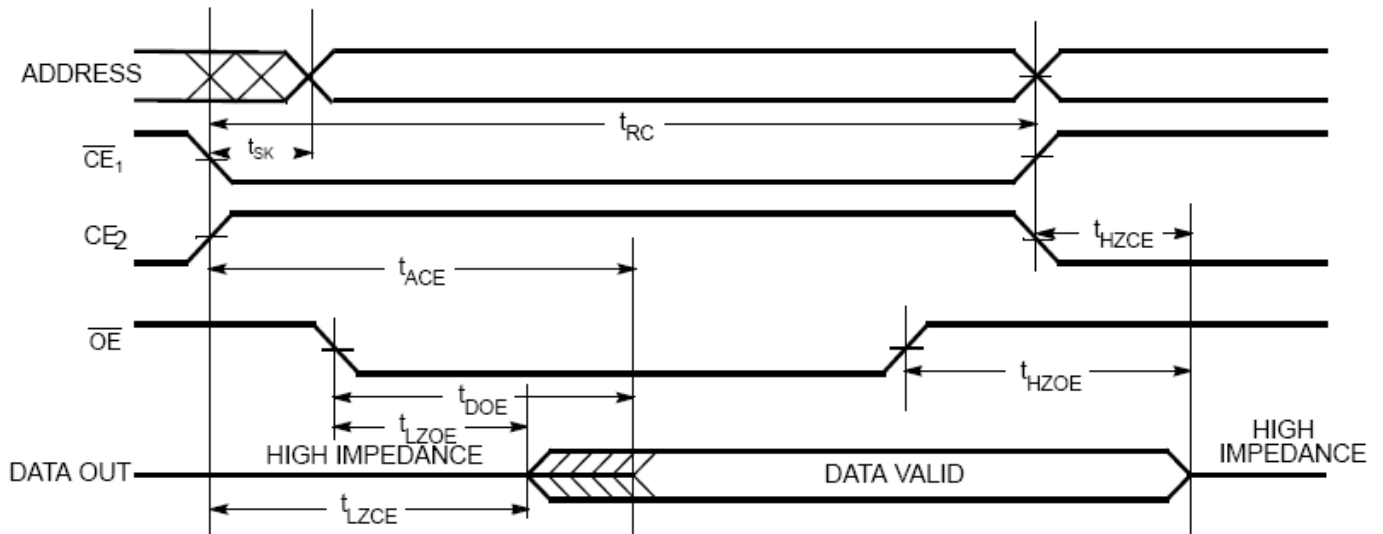

Notes:

- 12. Device is continuously selected. \overline{OE} , $\overline{CE}_1 = V_{IL}$ and $CE_2 = V_{IH}$.
- 13. \overline{WE} is HIGH for Read Cycle.

Switching Waveforms (continued)

Write Cycle No.1 (\overline{WE} Controlled)[9,10, 14, 15, 16]

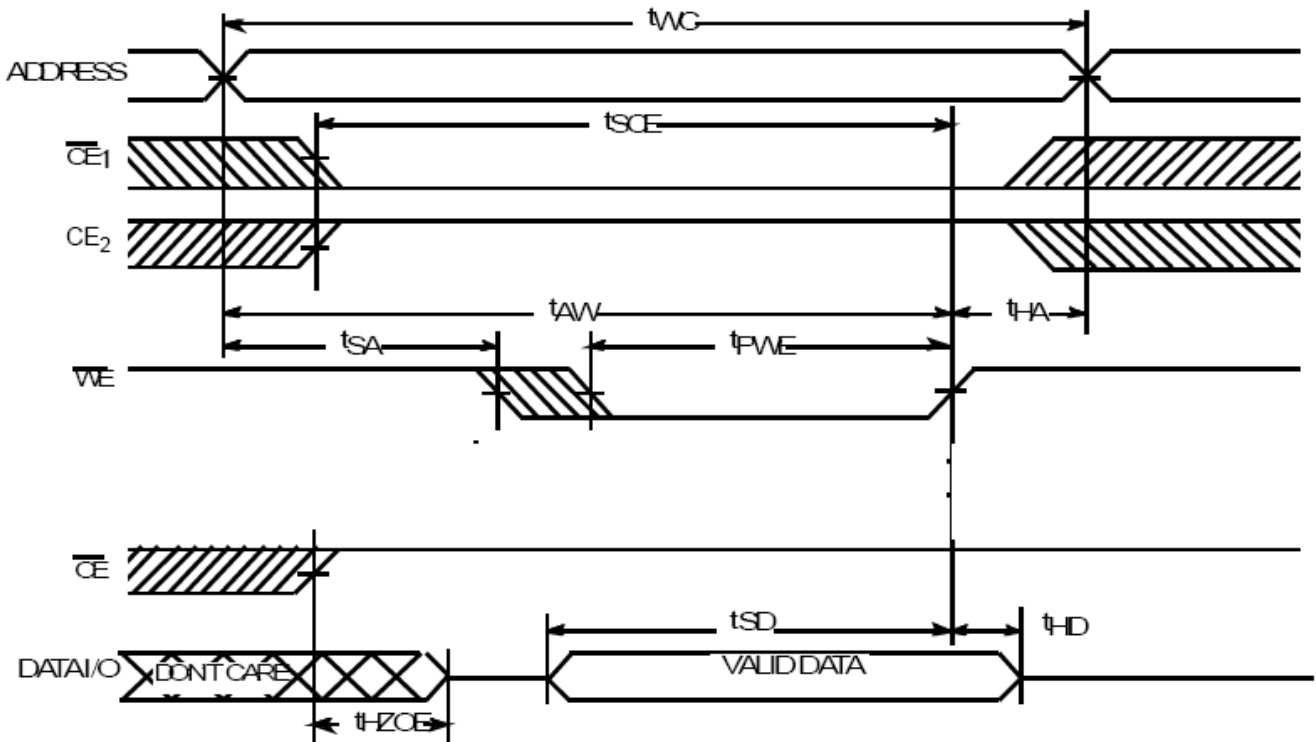

Write Cycle 2 (\overline{CE}_1 or \overline{CE}_2 Controlled) [9, 10, 14, 15, 16]

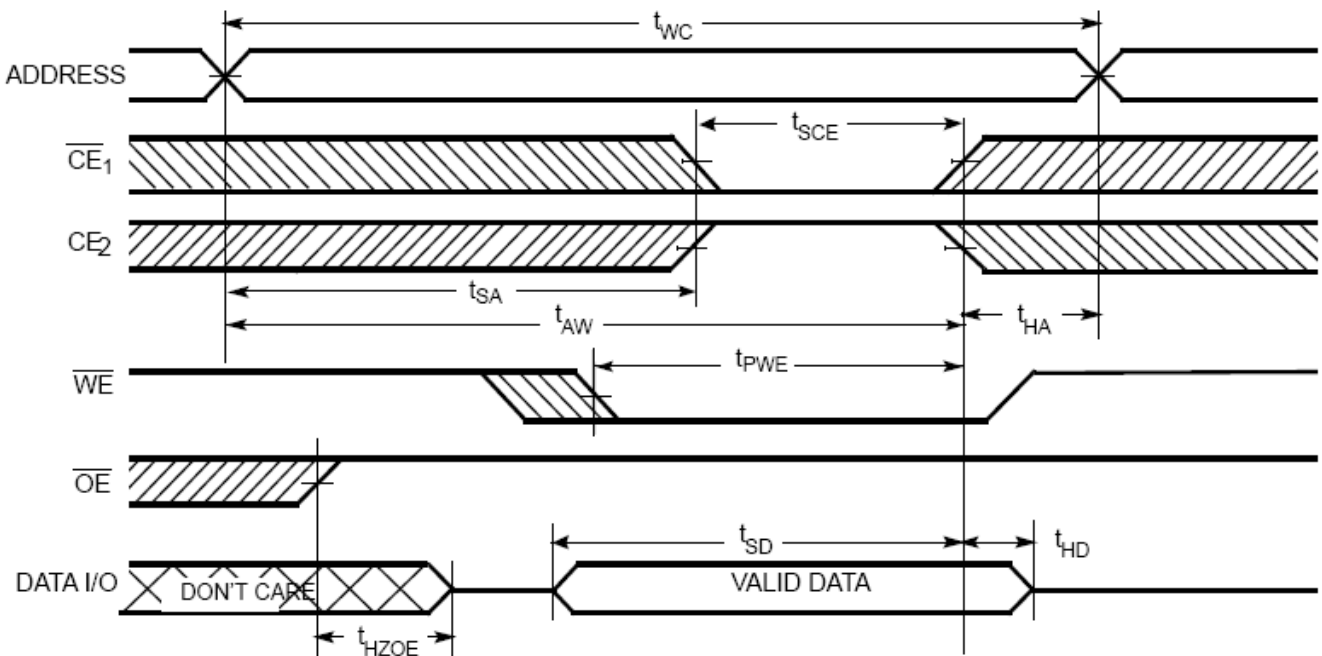

Notes:

14.Data I/O is high impedance if $\overline{OE} \geq V_{IH}$.

15. If Chip Enables go INACTIVE simultaneously with $\overline{WE} = \text{HIGH}$, the output remains in a high-impedance state.

16.During the DON'T CARE period in the DATA I/O waveform, the I/Os are in output state and input signals should not be applied.

Switching Waveforms (continued)

Write Cycle 3 (\overline{WE} Controlled, \overline{OE} LOW)[15, 16]

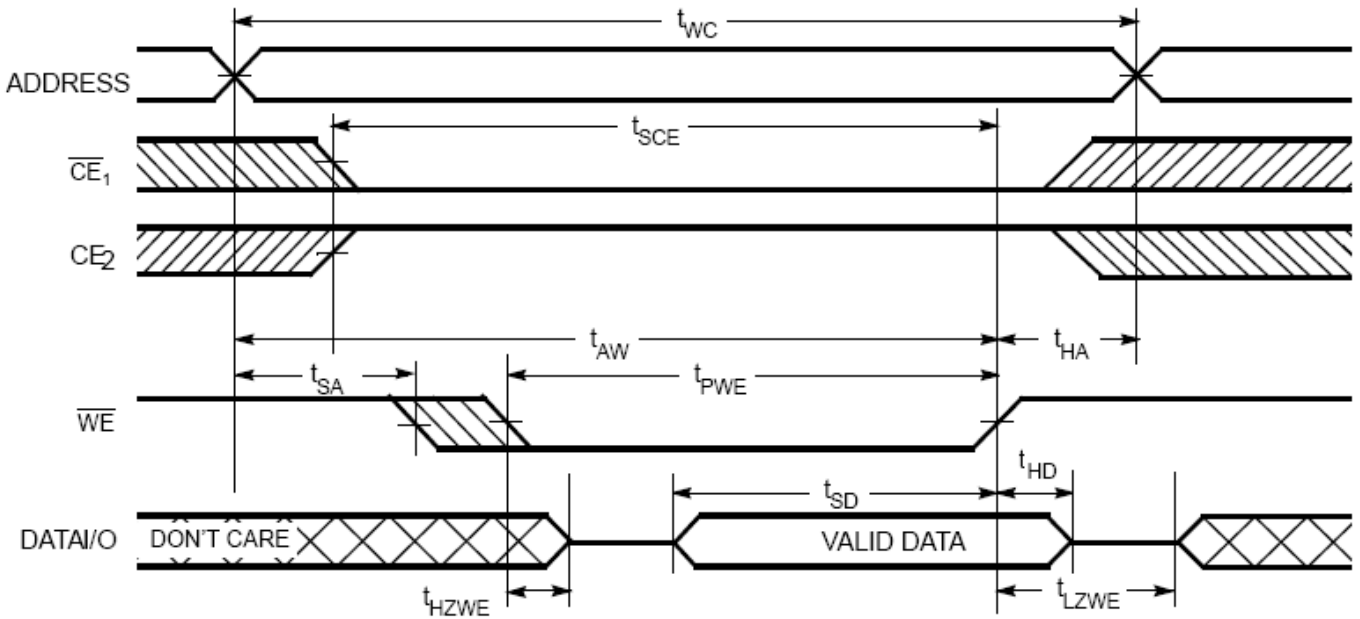

Truth Table[17]

\overline{CE}_1	\overline{CE}_2	\overline{OE}	\overline{WE}	I/O ₀ -I/O ₇	Mode	Power
H	X	X	X	High Z	Power-Down	Standby (I_{SB})
X	L	X	X	High Z	Power-Down	Standby (I_{SB})
L	H	L	H	Data Out	Read	Active (I_{CC})
L	H	X	L	Data In	Write	Active (I_{CC})
L	H	H	H	High Z	Selected, Outputs Disabled	Active (I_{CC})

Ordering Information

Speed (ns)	Ordering Code	Package Type	Operating Range
55	M24L28256DA-55BEG	36-Lead VFBGA (6 x 8 x 1 mm) (Pb-free)	Extended
70	M24L28256DA-70BEG	36-Lead VFBGA (6 x 8 x 1 mm) (Pb-free)	Extended

Note:

17.H = Logic HIGH, L = Logic LOW, X = Don't Care.

Package Diagrams

36-Lead VFBGA (6 x 8 x 1 mm)

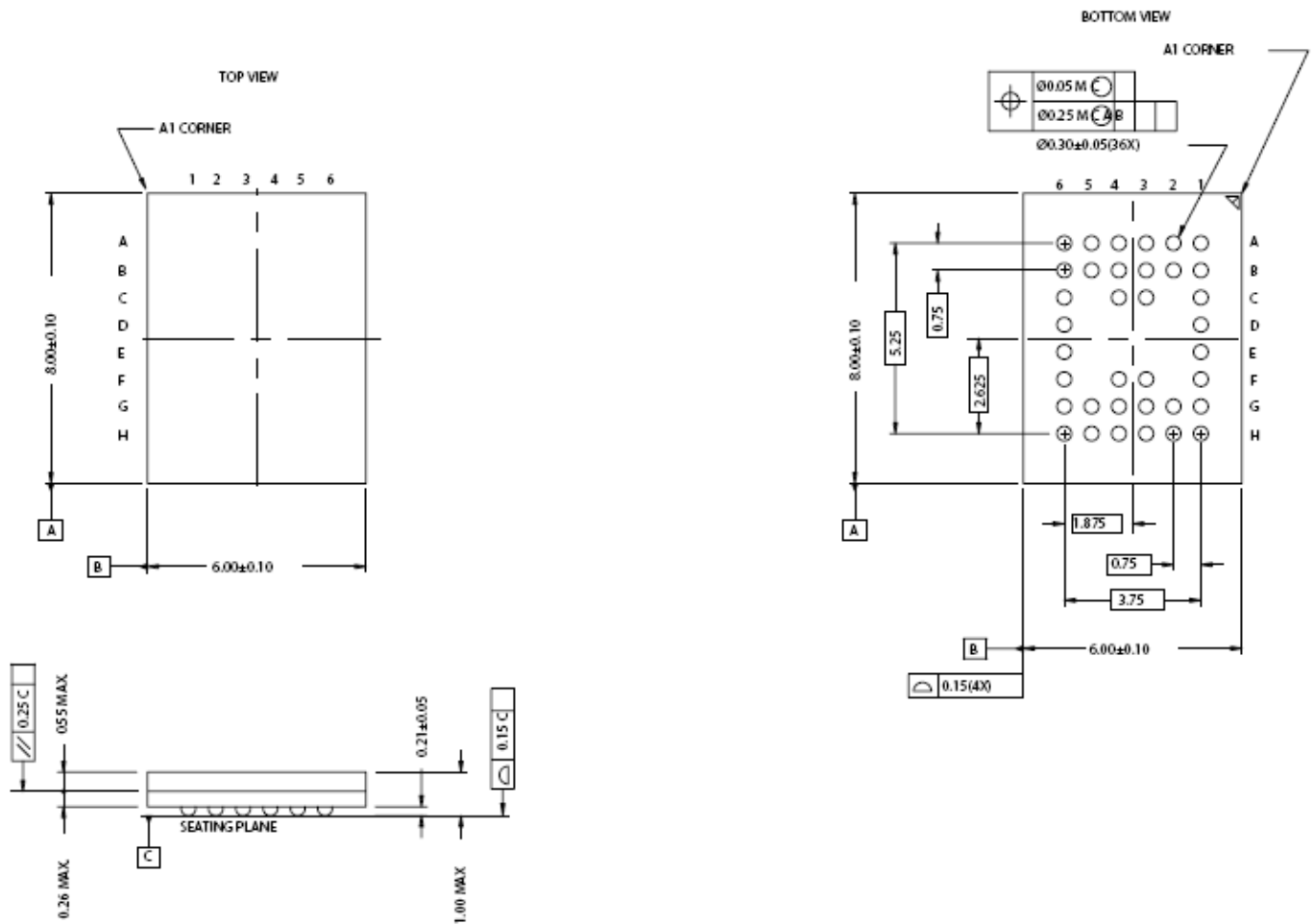

Revision History

Revision	Date	Description
1.0	2007.07.19	Original

Important Notice

All rights reserved.

No part of this document may be reproduced or duplicated in any form or by any means without the prior permission of ESMT.

The contents contained in this document are believed to be accurate at the time of publication. ESMT assumes no responsibility for any error in this document, and reserves the right to change the products or specification in this document without notice.

The information contained herein is presented only as a guide or examples for the application of our products. No responsibility is assumed by ESMT for any infringement of patents, copyrights, or other intellectual property rights of third parties which may result from its use. No license, either express, implied or otherwise, is granted under any patents, copyrights or other intellectual property rights of ESMT or others.

Any semiconductor devices may have inherently a certain rate of failure. To minimize risks associated with customer's application, adequate design and operating safeguards against injury, damage, or loss from such failure, should be provided by the customer when making application designs.

ESMT's products are not authorized for use in critical applications such as, but not limited to, life support devices or system, where failure or abnormal operation may directly affect human lives or cause physical injury or property damage. If products described here are to be used for such kinds of application, purchaser must do its own quality assurance testing appropriate to such applications.