

Features

- Thin small outline package (TSOP I) Configurable as 1M x 16 or as 2M x 8 SRAM
- Wide voltage range: 2.2 V – 3.6 V
- Ultra-low active power: Typical active current: 2 mA at f = 1 MHz
- Ultra-low standby power
- Easy memory expansion with \overline{CE}_1 , CE_2 and \overline{OE} features
- Automatic power-down when deselected
- Complementary metal oxide semiconductor (CMOS) for optimum speed / power
- Available in Pb-free and non Pb-free 48-ball very fine ball grid array (VFBGA) and 48-pin TSOP I package

Functional Description^[1]

The CY62167DV30 is a high-performance CMOS static RAM organized as 1M words by 16 bits. This device features advanced circuit design to provide ultra-low active current. This is ideal for providing More Battery Life™ (MoBL®) in portable applications such as cellular telephones. The device

also has an automatic power-down feature that significantly reduces power consumption by 99% when addresses are not toggling. The device can also be put into standby mode when deselected (\overline{CE}_1 HIGH or CE_2 LOW or both BHE and BLE are HIGH). The input/output pins (I/O₀ through I/O₁₅) are placed in a high-impedance state when: deselected (\overline{CE}_1 HIGH or CE_2 LOW), outputs are disabled (\overline{OE} HIGH), both Byte High Enable and Byte Low Enable are disabled (BHE, BLE HIGH), or during a Write operation (\overline{CE}_1 LOW, CE_2 HIGH and WE LOW).

Writing to the device is accomplished by taking Chip Enables (\overline{CE}_1 LOW and CE_2 HIGH) and Write Enable (WE) input LOW. If Byte Low Enable (BLE) is LOW, then data from I/O pins (I/O₀ through I/O₇), is written into the location specified on the address pins (A₀ through A₁₉). If Byte High Enable (BHE) is LOW, then data from I/O pins (I/O₈ through I/O₁₅) is written into the location specified on the address pins (A₀ through A₁₉).

Reading from the device is accomplished by taking Chip Enables (\overline{CE}_1 LOW and CE_2 HIGH) and Output Enable (\overline{OE}) LOW while forcing the Write Enable (WE) HIGH. If Byte Low Enable (BLE) is LOW, then data from the memory location specified by the address pins will appear on I/O₀ to I/O₇. If Byte High Enable (BHE) is LOW, then data from memory will appear on I/O₈ to I/O₁₅. See the truth table at the back of this data sheet for a complete description of Read and Write modes.

Logic Block Diagram

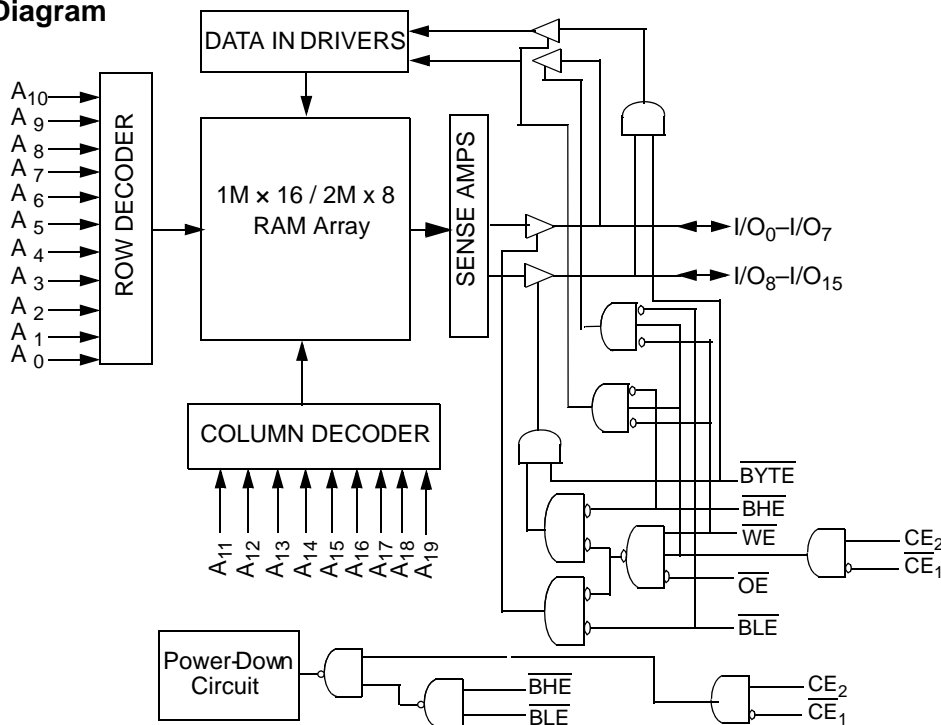

Note

1. For best-practice recommendations, please refer to the Cypress application note "System Design Guidelines" on <http://www.cypress.com>.

Contents

Product Portfolio	3	Switching Waveforms	7
Pin Configuration	3	Truth Table	11
Maximum Ratings	4	Ordering Information	12
Operating Range	4	Ordering Code Definition	12
Electrical Characteristics	4	Acronyms	15
Capacitance	5	Document Conventions	15
Thermal Resistance	5	Units of Measure	15
AC Test Loads and Waveforms	5	Sales, Solutions, and Legal Information	17
Data Retention Characteristics	5	Worldwide Sales and Design Support	17
Data Retention Waveform	6	Products	17
Switching Characteristics	6	PSoC Solutions	17

Product Portfolio

Product	V _{CC} Range (V)			Speed (ns)	Power Dissipation					
					Operating I _{CC} (mA)				Standby I _{SB2} (μ A)	
	Min	Typ ^[2]	Max		f = 1MHz		f = f _{Max}			
					Typ ^[2]	Max	Typ ^[2]	Max	Typ ^[2]	Max
CY62167DV30LL	2.2	3.0	3.6	55	2	4	15	30	2.5	22
				70			12	25		

Pin Configuration

Figure 1. 48- ball VFBGA Top View^[3, 4, 5]

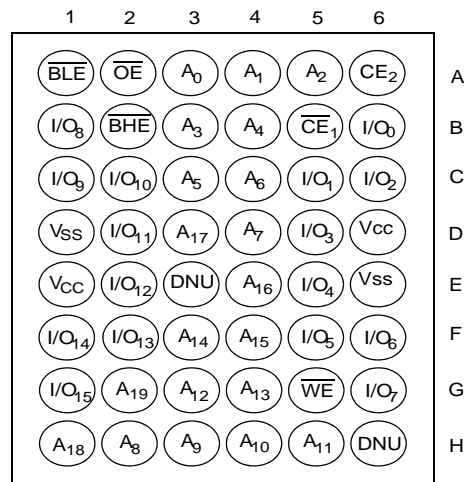

48-Pin TSOP I (Forward) (1M x 16/ 2M x 8)^[6]
Top View



Notes

- Typical values are included for reference only and are not guaranteed or tested. Typical values are measured at V_{CC} = V_{CC(typ)}, T_A = 25 °C.
- NC pins are not connected on the die.
- DNU pins have to be left floating.
- Ball H6 for the FBGA package can be used to upgrade to a 32M density.
- The BYTE pin in the 48-TSOP I package has to be tied to V_{CC} to use the device as a 1M X 16 SRAM. The 48-TSOP I package can also be used as a 2M X 8 SRAM by tying the BYTE signal to V_{SS}. In the 2M x 8 configuration, Pin 45 is A20, while BHE, BLE and I/O8 to I/O14 pins are not used (DNU).

Maximum Ratings

(Above which the useful life may be impaired. For user guidelines, not tested.)

- Storage temperature -65 °C to +150 °C
- Ambient temperature with power applied -55 °C to +125 °C
- Supply voltage to ground potential -0.2 V to $V_{CC} + 0.3$ V
- DC voltage applied to outputs in High-Z state^[7, 8] -0.2 V to $V_{CC} + 0.3$ V
- DC input voltage^[7, 8] -0.2 V to $V_{CC} + 0.3$ V

- Output current into outputs (LOW) 20 mA
- Static discharge voltage > 2001 V (per MIL-STD-883, Method 3015)
- Latch-up current > 200 mA

Operating Range

Device	Range	Ambient Temperature	V_{CC} ^[9]
CY62167DV30LL	Industrial	-40 °C to +85 °C	2.20 V to 3.60 V

Electrical Characteristics Over the Operating Range

Parameter	Description	Test Conditions	CY62167DV30-55			CY62167DV30-70			Unit
			Min	Typ ^[10]	Max	Min	Typ ^[10]	Max	
V_{OH}	Output HIGH voltage	$I_{OH} = -0.1$ mA $V_{CC} = 2.20$ V	2.0	-	-	2.0	-	-	V
		$I_{OH} = -1.0$ mA $V_{CC} = 2.70$ V	2.4			2.4			
V_{OL}	Output LOW voltage	$I_{OL} = 0.1$ mA $V_{CC} = 2.20$ V	-	-	0.4	-	-	0.4	V
		$I_{OL} = 2.1$ mA $V_{CC} = 2.70$ V							
V_{IH}	Input HIGH voltage	$V_{CC} = 2.2$ V to 2.7 V	1.8	-	$V_{CC} + 0.3$ V	1.8	-	$V_{CC} + 0.3$ V	V
		$V_{CC} = 2.7$ V to 3.6 V	2.2			2.2			
V_{IL}	Input LOW voltage	$V_{CC} = 2.2$ V to 2.7 V	-0.3	-	0.6	-0.3	-	0.6	V
		$V_{CC} = 2.7$ V to 3.6 V			0.8			0.8	
I_{IX}	Input leakage current	$GND \leq V_I \leq V_{CC}$	-1	-	+1	-1	-	+1	μ A
I_{OZ}	Output leakage current	$GND \leq V_O \leq V_{CC}$, Output Disabled	-1	-	+1	-1	-	+1	μ A
I_{CC}	V_{CC} Operating supply current	$V_{CC} = V_{CC(max)}$ $I_{OUT} = 0$ mA CMOS levels	-	15	30	-	12	25	mA
		$f = f_{Max} = 1/t_{RC}$ $f = 1$ MHz		2	4		2	4	
I_{SB1}	Automatic Power-down current — CMOS inputs	$\overline{CE}_1 \geq V_{CC} - 0.2$ V or $CE_2 \leq 0.2$ V, $V_{IN} \geq V_{CC} - 0.2$ V, $V_{IN} \leq 0.2$ V, $f = f_{Max}$ (Address and data only), $f = 0$ (OE, WE), $V_{CC} = 3.60$ V	-	2.5	22	-	2.5	22	μ A
I_{SB2}	Automatic Power-down current — CMOS Inputs	$\overline{CE}_1 \geq V_{CC} - 0.2$ V or $CE_2 \leq 0.2$ V, $V_{IN} \geq V_{CC} - 0.2$ V or $V_{IN} \leq 0.2$ V, $f = 0$, $V_{CC} = 3.60$ V	-	2.5	22	-	2.5	22	μ A

Notes

7. $V_{IL(min)}$ = -2.0 V for pulse durations less than 20 ns.
8. $V_{IH(max)}$ = $V_{CC} + 0.75$ V for pulse durations less than 20 ns.
9. Full Device AC operation requires linear V_{CC} ramp from 0 to $V_{CC(min)}$ and V_{CC} must be stable at $V_{CC(min)}$ for 500 μ s.
10. Typical values are included for reference only and are not guaranteed or tested. Typical values are measured at $V_{CC} = V_{CC(typ)}$, $T_A = 25$ °C

Capacitance

Parameter ^[11]	Description	Test Conditions	Max	Unit
C _{IN}	Input capacitance	T _A = 25 °C, f = 1 MHz, V _{CC} = V _{CC(typ)}	8	pF
C _{OUT}	Output capacitance		10	pF

Thermal Resistance

Parameter ^[11]	Description	Test Conditions	VFBGA	TSOP I	Unit
Θ _{JA}	Thermal resistance (Junction to ambient)	Still Air, soldered on a 3 × 4.5 inch, 2-layer printed circuit board	55	60	°C / W
Θ _{JC}	Thermal resistance (Junction to case)		16	4.3	°C / W

AC Test Loads and Waveforms

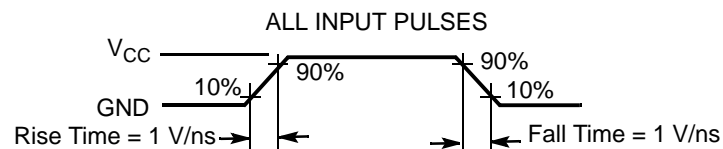
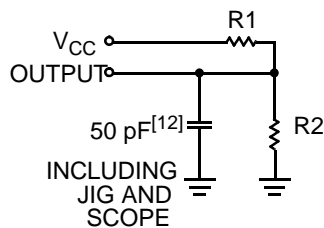

Equivalent to: THEVENIN EQUIVALENT

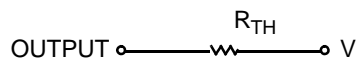

Parameters	2.5 V	3.0 V	Unit
R1	16667	1103	Ω
R2	15385	1554	Ω
R _{TH}	8000	645	Ω
V _{TH}	1.20	1.75	V

Data Retention Characteristics (Over the Operating Range)

Parameter	Description	Conditions	Min	Typ ^[12]	Max	Unit
V _{DR}	V _{CC} for Data retention		1.5	–	–	V
I _{CCDR}	Data retention current	V _{CC} = 1.5 V, CE ₁ ≥ V _{CC} – 0.2 V or CE ₂ ≤ 0.2 V, V _{IN} ≥ V _{CC} – 0.2 V or V _{IN} ≤ 0.2 V	–	–	10	μA
t _{CDR} ^[11]	Chip deselect to data retention time		0	–	–	ns
t _R ^[13]	Operation recovery time	CY62167DV30LL-55	55	–	–	ns
		CY62167DV30LL-70	70	–	–	ns

Notes

11. Tested initially and after any design or process changes that may affect these parameters.

12. Typical values are included for reference only and are not guaranteed or tested. Typical values are measured at V_{CC} = V_{CC(typ)}, T_A = 25 °C

13. Full device operation requires linear V_{CC} ramp from V_{DR} to V_{CC(min.)} ≥ 100 μs or stable at V_{CC(min.)} ≥ 100 μs.

Data Retention Waveform^[14]

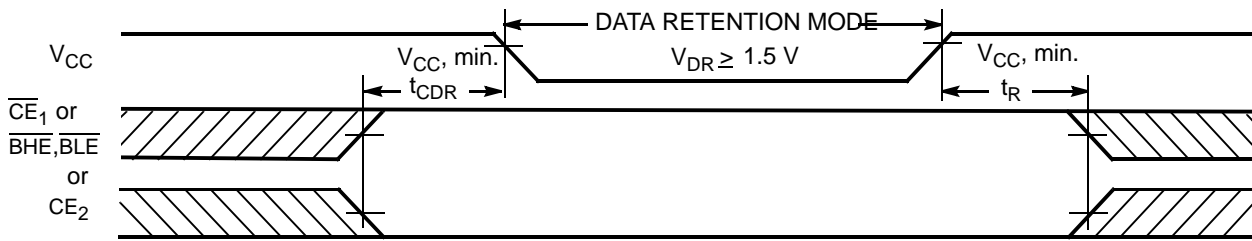

Switching Characteristics Over the Operating Range

Parameter ^[15]	Description	55 ns		70 ns		Unit
		Min	Max	Min	Max	
Read Cycle^[15]						
t _{RC}	Read cycle time	55	–	70	–	ns
t _{AA}	Address to data valid	–	55	–	70	ns
t _{OHA}	Data hold from address change	10	–	10	–	ns
t _{ACE}	CE ₁ LOW and CE ₂ HIGH to data valid	–	55	–	70	ns
t _{DOE}	OE LOW to data valid	–	25	–	35	ns
t _{LZOE}	OE LOW to Low Z ^[16]	5	–	5	–	ns
t _{HZOE}	OE HIGH to High Z ^[16, 17]	–	20	–	25	ns
t _{LZCE}	CE ₁ LOW and CE ₂ HIGH to Low Z ^[16]	10	–	10	–	ns
t _{HZCE}	CE ₁ HIGH and CE ₂ LOW to High Z ^[16, 17]	–	20	–	25	ns
t _{PU}	CE ₁ LOW and CE ₂ HIGH to Power-up	0	–	0	–	ns
t _{PD}	CE ₁ HIGH and CE ₂ LOW to Power-down	–	55	–	70	ns
t _{DBE}	BLE/BHE LOW to data valid	–	55	–	70	ns
t _{LZBE}	BLE/BHE LOW to Low Z ^[16]	10	–	10	–	ns
t _{HZBE}	BLE/BHE HIGH to HIGH Z ^[16, 17]	–	20	–	25	ns
Write Cycle^[18]						
t _{WC}	Write cycle time	55	–	70	–	ns
t _{SCE}	CE ₁ LOW and CE ₂ HIGH to write end	40	–	60	–	ns
t _{AW}	Address set-up to write end	40	–	60	–	ns
t _{HA}	Address hold from write end	0	–	0	–	ns
t _{SA}	Address set-up to write start	0	–	0	–	ns
t _{PWE}	WE pulse width	40	–	45	–	ns
t _{BW}	BLE/BHE LOW to write end	40	–	60	–	ns
t _{SD}	Data set-up to write end	25	–	30	–	ns
t _{HD}	Data hold from write end	0	–	0	–	ns
t _{HZWE}	WE LOW to High-Z ^[16, 17]	–	20	–	25	ns
t _{LZWE}	WE HIGH to Low-Z ^[16]	10	–	10	–	ns

Notes

- 14. BHE.BLE is the AND of both BHE and BLE. Chip can be deselected by either disabling the chip enable signals or by disabling both BHE and BLE.
- 15. Test conditions for all parameters other than Tri-state parameters assume signal transition time of 1 ns/V, timing reference levels of V_{CC(typ)}/2, input pulse levels of 0 to V_{CC(typ)}, and output loading of the specified I_{OL}/I_{OH} as shown in the "AC Test Loads and Waveforms" section.
- 16. At any given temperature and voltage condition, t_{HZCE} is less than t_{LZCE}, t_{HZBE} is less than t_{LZBE}, t_{HZOE} is less than t_{LZOE}, and t_{HZWE} is less than t_{LZWE} for any given device.
- 17. t_{HZOE}, t_{HZCE}, t_{HZBE}, and t_{HZWE} transitions are measured when the outputs enter a high impedance state.
- 18. The internal Write time of the memory is defined by the overlap of WE, CE₁ = V_{IL}, BHE and/or BLE = V_{IL}, and CE₂ = V_{IH}. All signals must be ACTIVE to initiate a write and any of these signals can terminate a write by going INACTIVE. The data input set-up and hold timing should be referenced to the edge of the signal that terminates the Write.

Switching Waveforms

Figure 2. Read Cycle 1 (Address Transition Controlled)^[19, 20]

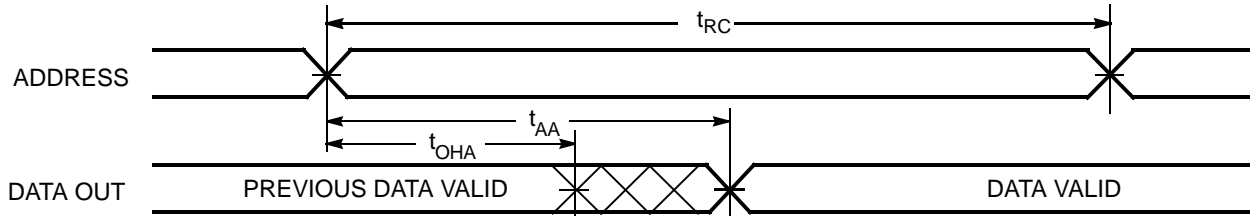
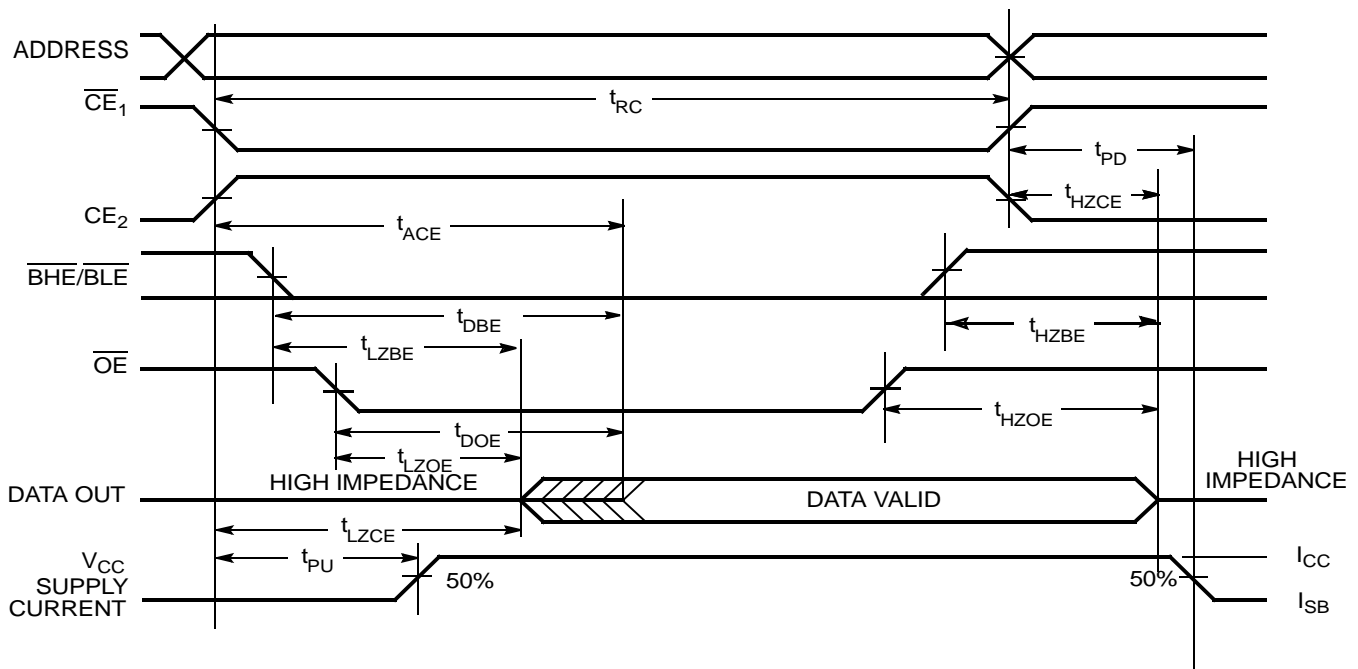

Figure 3. Read Cycle 2 ($\overline{\text{OE}}$ Controlled)^[20, 21]



Notes

19. The device is continuously selected. $\overline{\text{OE}}$, $\overline{\text{CE}}_1 = V_{\text{IL}}$, $\overline{\text{BHE}}$ and/or $\overline{\text{BLE}} = V_{\text{IL}}$, and $\text{CE}_2 = V_{\text{IH}}$.

20. $\overline{\text{WE}}$ is HIGH for read cycle.

21. Address valid prior to or coincident with $\overline{\text{CE}}_1$, $\overline{\text{BHE}}$, $\overline{\text{BLE}}$ transition LOW and CE_2 transition HIGH.

Switching Waveforms (continued)

Figure 4. Write Cycle 1 (\overline{WE} Controlled)^[22, 23, 24]

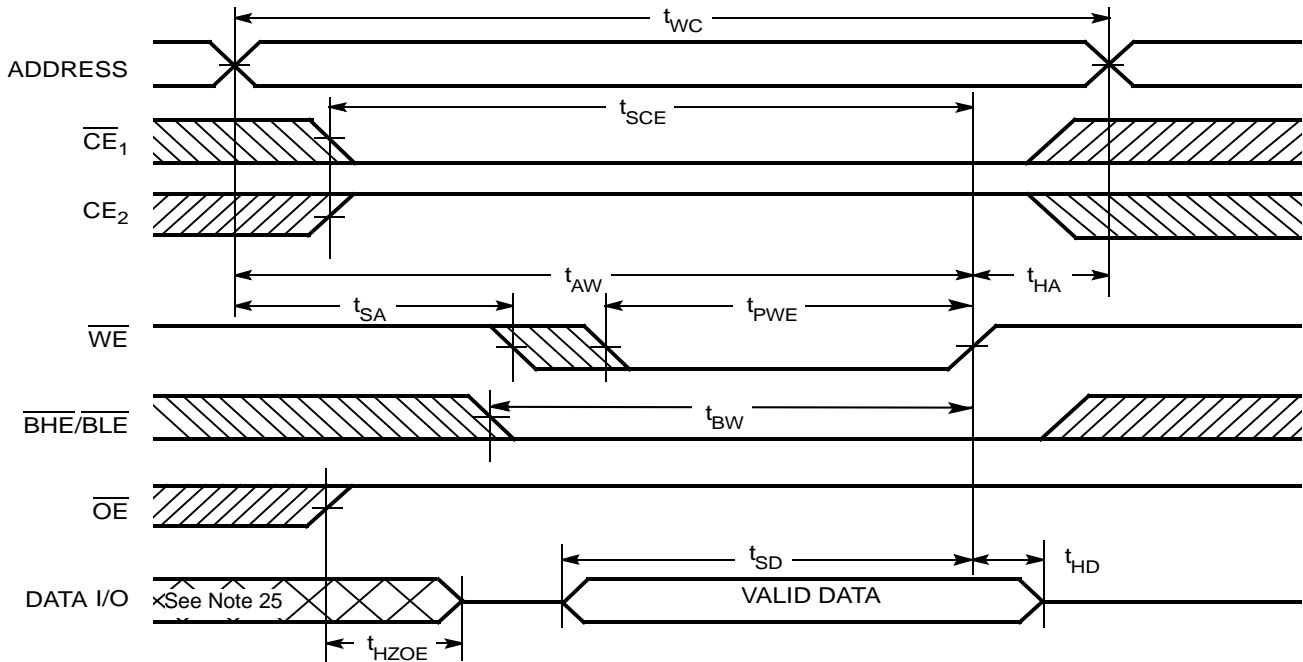

Notes

- 22. The internal Write time of the memory is defined by the overlap of \overline{WE} , $\overline{CE}_1 = V_{IL}$, \overline{BHE} and/or $\overline{BLE} = V_{IL}$, and $CE_2 = V_{IH}$. All signals must be ACTIVE to initiate a write and any of these signals can terminate a write by going INACTIVE. The data input set-up and hold timing should be referenced to the edge of the signal that terminates the Write.
- 23. Data I/O is high-impedance if $\overline{OE} = V_{IH}$.
- 24. If \overline{CE}_1 goes HIGH and CE_2 goes LOW simultaneously with $\overline{WE} = V_{IH}$, the output remains in a high-impedance state.
- 25. During this period, the I/Os are in output state and input signals should not be applied.

Switching Waveforms (continued)

Figure 5. Write Cycle 2 (\overline{CE}_1 or CE_2 Controlled)^[26, 27, 28]

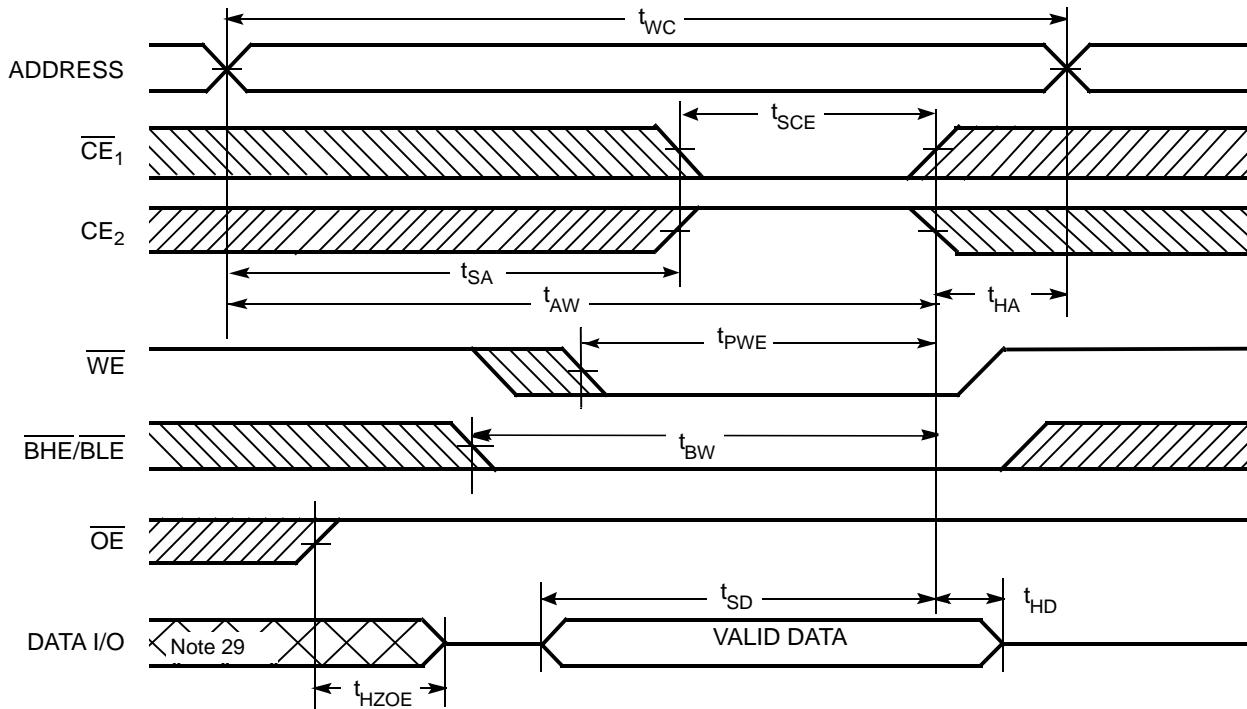
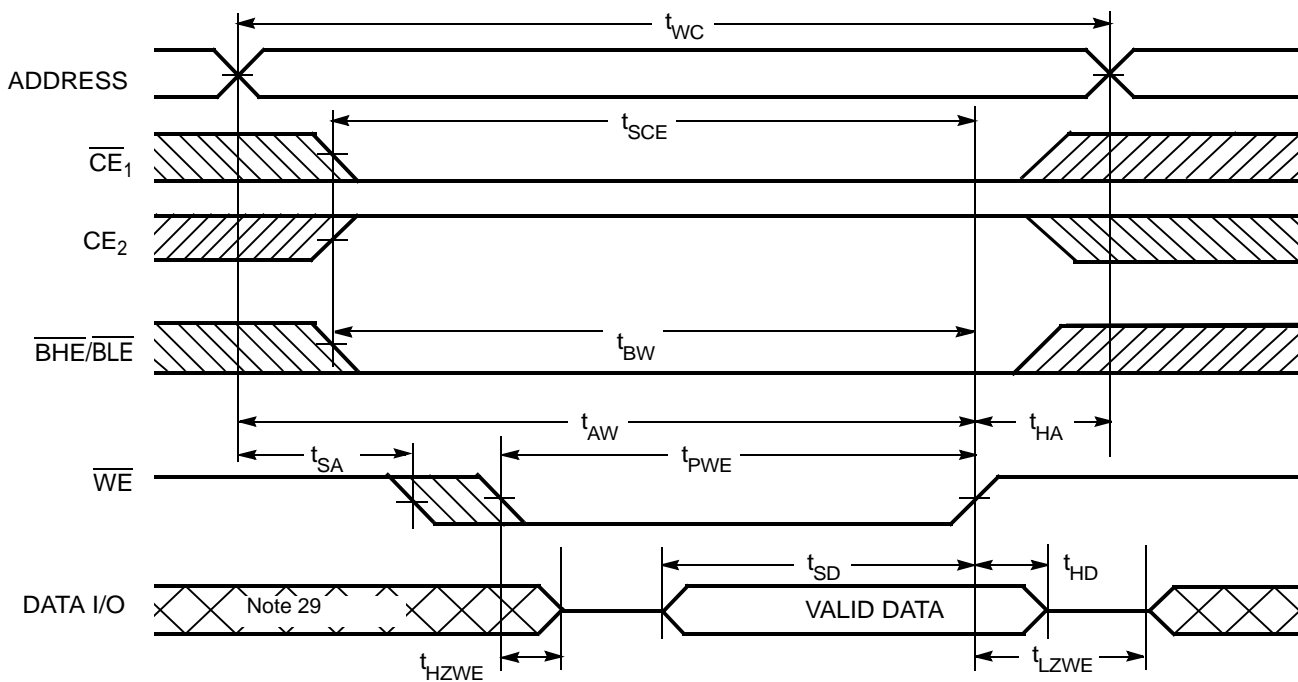

Figure 6. Write Cycle 3 (\overline{WE} Controlled, \overline{OE} LOW)^[28]



Notes

- 26. The internal Write time of the memory is defined by the overlap of \overline{WE} , $\overline{CE}_1 = V_{IL}$, \overline{BHE} and/or $\overline{BLE} = V_{IL}$, and $CE_2 = V_{IH}$. All signals must be ACTIVE to initiate a write and any of these signals can terminate a write by going INACTIVE. The data input set-up and hold timing should be referenced to the edge of the signal that terminates the Write.
- 27. Data I/O is high-impedance if $\overline{OE} = V_{IH}$.
- 28. If \overline{CE}_1 goes HIGH and CE_2 goes LOW simultaneously with $\overline{WE} = V_{IH}$, the output remains in a high-impedance state.
- 29. During this period, the I/Os are in output state and input signals should not be applied.

Switching Waveforms (continued)

Figure 7. Write Cycle 4 ($\overline{\text{BHE}}/\overline{\text{BLE}}$ Controlled, $\overline{\text{OE}}$ LOW)^[30]

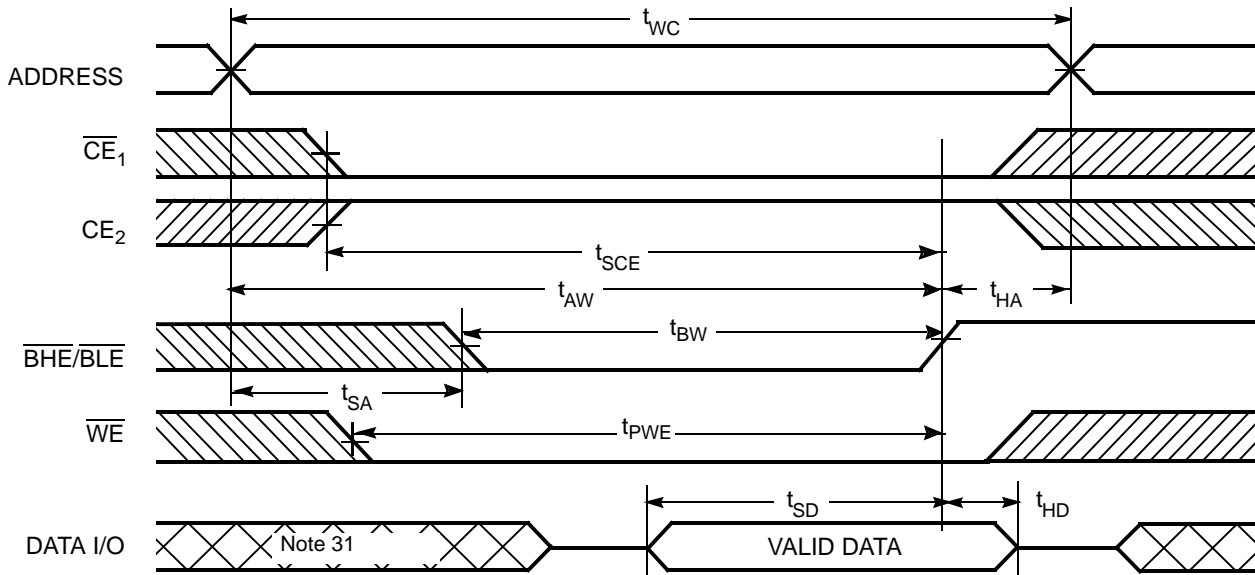

Notes

- 30. If $\overline{\text{CE}}_1$ goes HIGH and CE_2 goes LOW simultaneously with $\overline{\text{WE}} = V_{IH}$, the output remains in a high-impedance state
- 31. During this period, the I/Os are in output state and input signals should not be applied.

Truth Table

\overline{CE}_1	CE_2	\overline{WE}	\overline{OE}	\overline{BHE}	\overline{BLE}	Inputs/Outputs	Mode	Power
H	X	X	X	X	X	High Z	Deselect/Power-down	Standby (I_{SB})
X	L	X	X	X	X	High Z	Deselect/Power-down	Standby (I_{SB})
X	X	X	X	H	H	High Z	Deselect/Power-down	Standby (I_{SB})
L	H	H	L	L	L	Data out (I/O_0 – I/O_{15})	Read	Active (I_{CC})
L	H	H	L	H	L	High Z (I/O_8 – I/O_{15}); Data out (I/O_0 – I/O_7)	Read	Active (I_{CC})
L	H	H	L	L	H	Data out (I/O_8 – I/O_{15}); High Z (I/O_0 – I/O_7)	Read	Active (I_{CC})
L	H	L	X	L	L	Data in (I/O_0 – I/O_{15})	Write	Active (I_{CC})
L	H	L	X	H	L	High Z (I/O_8 – I/O_{15}); Data in (I/O_0 – I/O_7)	Write	Active (I_{CC})
L	H	L	X	L	H	Data in (I/O_8 – I/O_{15}); High Z (I/O_0 – I/O_7)	Write	Active (I_{CC})
L	H	H	H	L	H	High Z	Output disabled	Active (I_{CC})
L	H	H	H	H	L	High Z	Output disabled	Active (I_{CC})
L	H	H	H	L	L	High Z	Output disabled	Active (I_{CC})

Ordering Information

Speed (ns)	Ordering Code	Package Diagram	Package Type	Operating Range
55	CY62167DV30LL-55BVI	51-85178	48-ball Fine Pitch BGA (8 x 9.5 x 1 mm)	Industrial
	CY62167DV30LL-55BVXI		48-ball Fine Pitch BGA (8 x 9.5 x 1 mm) (Pb-free)	
	CY62167DV30LL-55ZXI	51-85183	48-pin TSOP I (12 x 18.4 x 1 mm) (Pb-free)	
70	CY62167DV30LL-70BVI	51-85178	48-ball Fine Pitch BGA (8 x 9.5 x 1 mm)	

Please contact your local Cypress sales representative for availability of these parts

Ordering Code Definition

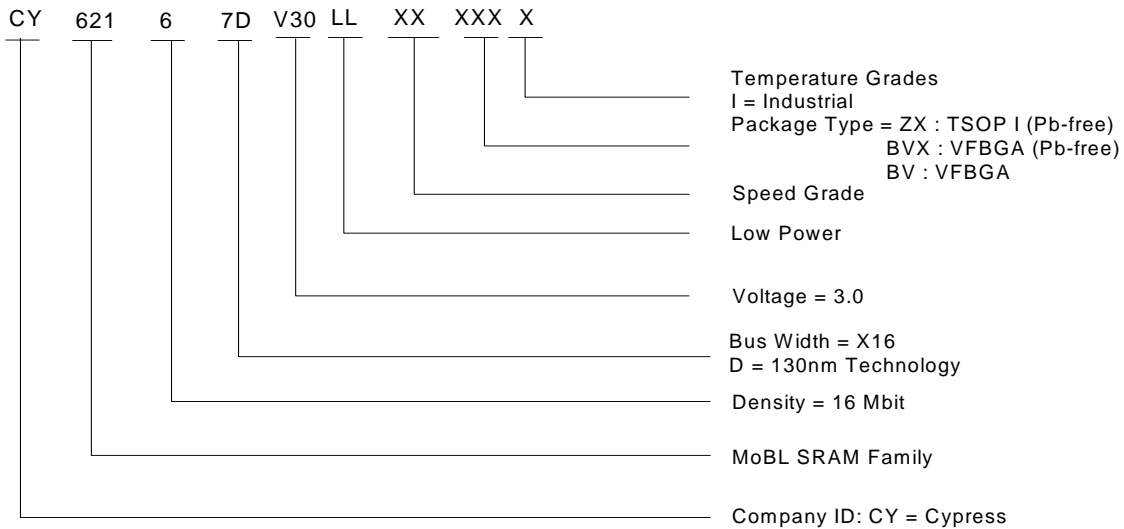

Package Diagrams

48-ball VFBGA (8 x 9.5 x 1 mm) (51-85178)

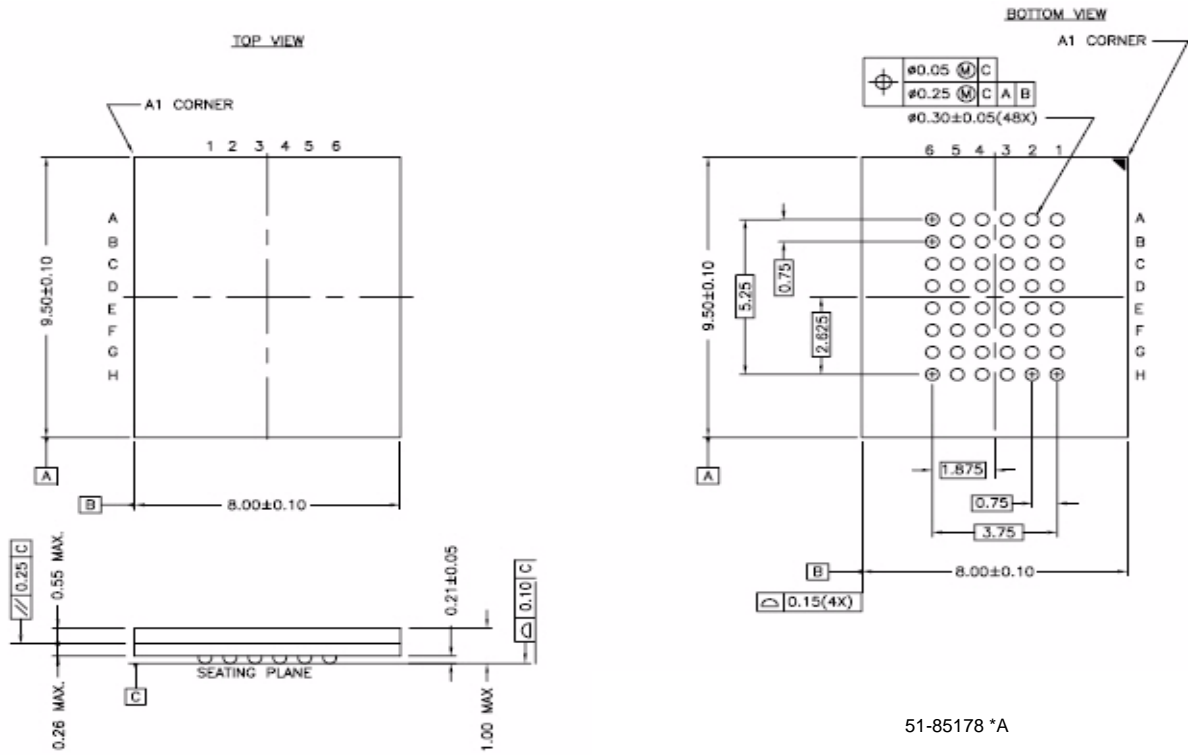

51-85178 *A

48-pin TSOP I (12 x 18.4 x 1 mm) (51-85183)

DIMENSIONS IN INCHES[MM] $\frac{\text{MIN.}}{\text{MAX.}}$

JEDEC # MO-142

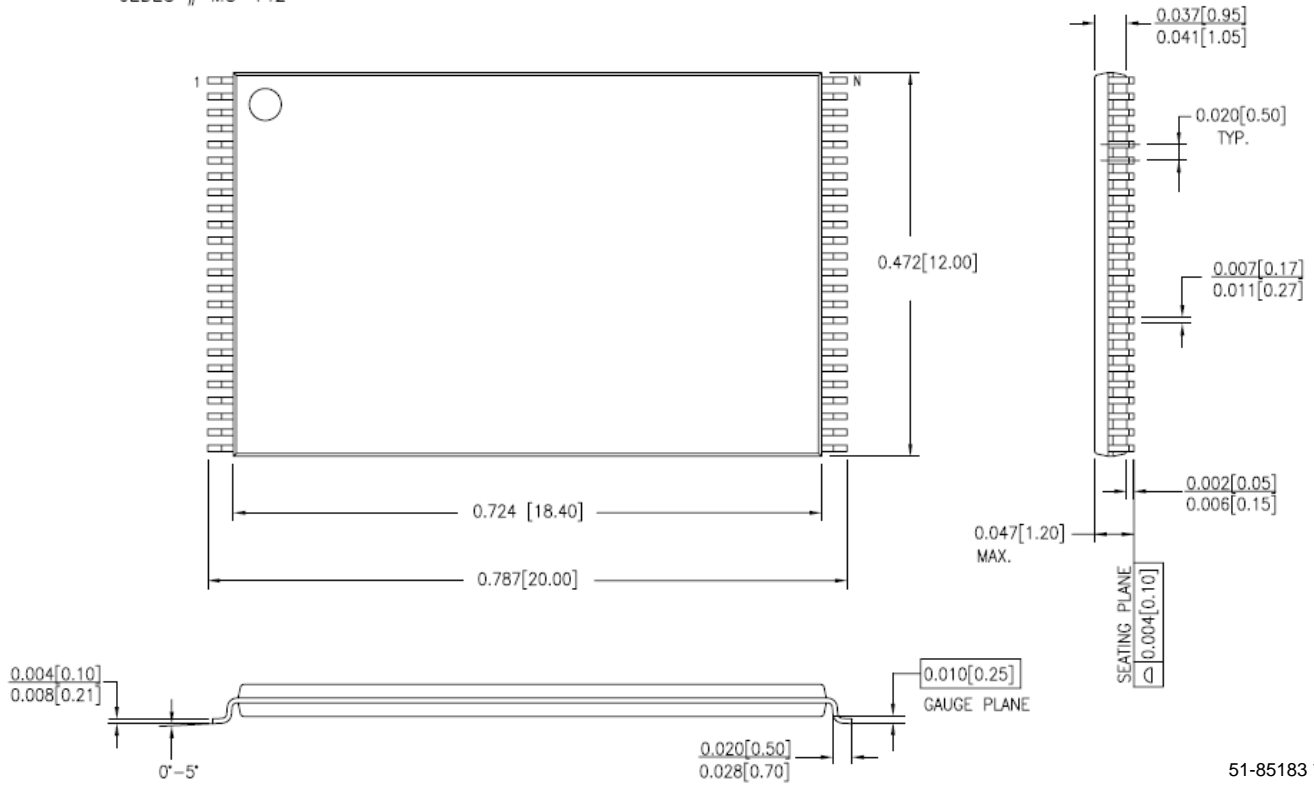

51-85183 *B

Acronyms

Acronym	Description
CMOS	complementary metal oxide semiconductor
I/O	input/output
SRAM	static random access memory
VFBGA	very fine ball grid array
TSOP	thin small outline package

Document Conventions

Units of Measure

Symbol	Unit of Measure
°C	degrees Celsius
μA	microamperes
mA	milliampere
MHz	megahertz
ns	nanoseconds
pF	picofarads
V	volts
Ω	ohms
W	watts

Document History Page

Document Title: CY62167DV30 MoBL®, 16-Mbit (1M x 16) Static RAM Document Number: 38-05328				
REV.	ECN NO.	Issue Date	Orig. of Change	Description of Change
**	118408	09/30/02	GUG	New Data Sheet
*A	123692	02/11/03	DPM	Changed Advanced to Preliminary Added package diagram
*B	126555	04/25/03	DPM	Minor change: Changed Sunset Owner from DPM to HRT
*C	127841	09/10/03	XRJ	Added 48 TSOP I package
*D	205701		AJU	Changed BYTE pin usage description for 48 TSOPI package
*E	238050	See ECN	KKV/AJU	Replaced 48-ball VFBGA package diagram; Modified Package Name in Ordering Information table from BV48A to BV48B
*F	304054	See ECN	PCI	Added 45-ns Speed Bin in AC, DC and Ordering Information tables Added Footnote #12 on page #4 Added Pb-free packages on page # 10
*G	492895	See ECN	VKN	Modified datasheet to explain x8 configurability Removed L power bin from the product offering Updated Ordering Information Table
*H	2896036	03/19/2010	AJU	Removed 45-ns. Removed inactive parts from Ordering Information. Updated Packaging Information Updated links in Sales, Solutions, and Legal Information.
*I	3067267	11/08/2010	RAME	Updated datasheet as per new template Added Ordering Code Definition , Acronyms and Units of Measure . Updated all tablenotes to footnote. Package diagram updated 51-85178 from ** to *A

Sales, Solutions, and Legal Information

Worldwide Sales and Design Support

Cypress maintains a worldwide network of offices, solution centers, manufacturer's representatives, and distributors. To find the office closest to you, visit us at [Cypress Locations](#).

Products

Automotive	cypress.com/go/automotive
Clocks & Buffers	cypress.com/go/clocks
Interface	cypress.com/go/interface
Lighting & Power Control	cypress.com/go/powerpsoc cypress.com/go/plc
Memory	cypress.com/go/memory
Optical & Image Sensing	cypress.com/go/image
PSoC	cypress.com/go/psoc
Touch Sensing	cypress.com/go/touch
USB Controllers	cypress.com/go/USB
Wireless/RF	cypress.com/go/wireless

PSoC Solutions

psoc.cypress.com/solutions
PSoC 1 | PSoC 3 | PSoC 5

© Cypress Semiconductor Corporation, 2010. The information contained herein is subject to change without notice. Cypress Semiconductor Corporation assumes no responsibility for the use of any circuitry other than circuitry embodied in a Cypress product. Nor does it convey or imply any license under patent or other rights. Cypress products are not warranted nor intended to be used for medical, life support, life saving, critical control or safety applications, unless pursuant to an express written agreement with Cypress. Furthermore, Cypress does not authorize its products for use as critical components in life-support systems where a malfunction or failure may reasonably be expected to result in significant injury to the user. The inclusion of Cypress products in life-support systems application implies that the manufacturer assumes all risk of such use and in doing so indemnifies Cypress against all charges.

Any Source Code (software and/or firmware) is owned by Cypress Semiconductor Corporation (Cypress) and is protected by and subject to worldwide patent protection (United States and foreign), United States copyright laws and international treaty provisions. Cypress hereby grants to licensee a personal, non-exclusive, non-transferable license to copy, use, modify, create derivative works of, and compile the Cypress Source Code and derivative works for the sole purpose of creating custom software and or firmware in support of licensee product to be used only in conjunction with a Cypress integrated circuit as specified in the applicable agreement. Any reproduction, modification, translation, compilation, or representation of this Source Code except as specified above is prohibited without the express written permission of Cypress.

Disclaimer: CYPRESS MAKES NO WARRANTY OF ANY KIND, EXPRESS OR IMPLIED, WITH REGARD TO THIS MATERIAL, INCLUDING, BUT NOT LIMITED TO, THE IMPLIED WARRANTIES OF MERCHANTABILITY AND FITNESS FOR A PARTICULAR PURPOSE. Cypress reserves the right to make changes without further notice to the materials described herein. Cypress does not assume any liability arising out of the application or use of any product or circuit described herein. Cypress does not authorize its products for use as critical components in life-support systems where a malfunction or failure may reasonably be expected to result in significant injury to the user. The inclusion of Cypress' product in a life-support systems application implies that the manufacturer assumes all risk of such use and in doing so indemnifies Cypress against all charges.

Use may be limited by and subject to the applicable Cypress software license agreement.