



LINEAGE POWER®

QBDW033A0B Series Power Modules; DC-DC Converters

36-75V_{dc} Input; 9.6-12V_{dc} Output; 33A Output Current

BARRACUDA™ SERIES



RoHS Compliant

Features

- Compliant to RoHS EU Directive 2002/95/EC (-Z versions)
- Compliant to ROHS EU Directive 2002/95/EC with lead solder exemption (non-Z versions)
- High and flat efficiency profile >95.0% at 12V_{dc}, 30% to 100% rated output
- Wide input voltage range: 36-75V_{dc}
- Delivers up to 33A_{dc} output current
- Remote sense and output voltage trim
- Fully regulated output voltage
- Output voltage adjust: 8.1V_{dc} to 13.2V_{dc}
- Low output ripple and noise
- Industry standard, DOSA compliant, Quarter brick: 57.9 mm x 36.8 mm x 10.6 mm (2.28 in x 1.45 in x 0.42 in)
- Constant switching frequency
- Positive remote On/Off logic
- Output over current/voltage protection
- Digital interface with PMBus™ Rev.1.1 compliance
- Over temperature protection
- Wide operating temperature range (-40°C to 85°C)
- UL* 60950-1 Recognized, CSA† C22.2 No. 60950-1-03 Certified, and VDE‡ 0805:2001-12 (EN60950-1) Licensed
- CE mark 73/23/EEC and 96/68/EEC directives§
- Meets the voltage and current requirements for ETSI 300-132-2 and complies with and licensed for Basic insulation rating per EN60950-1
- 2250 Vdc Isolation tested in compliance with IEEE 802.3[¶] PoE standards
- ISO** 9001 and ISO14001 certified manufacturing facilities

Applications

- Distributed power architectures
- Intermediate bus voltage applications
- Servers and storage applications
- Networking equipment including Power over Ethernet (PoE)
- Fan assemblies other systems requiring a tightly regulated output voltage

Options

- Negative Remote On/Off logic
- Active load sharing (Parallel Operation)
- Baseplate option (-H)
- Auto restart after fault shutdown

Description

The QBDW033A0B series of dc-dc converters are a new generation of DC/DC power modules designed to support 9.6 -12V_{dc} intermediate bus applications where multiple low voltages are subsequently generated using point of load (POL) converters, as well as other application requiring a tightly regulated output voltage. The QBDW033A0B series operate from an input voltage range of 36 to 75V_{dc} and provide up to 33A output current at output voltages from 8.1V_{dc} to 12V_{dc} in a DOSA standard quarter brick. The converter incorporates digital control, synchronous rectification technology, a fully regulated control topology, and innovative packaging techniques to achieve efficiency approaching 97% peak at 12V_{dc} output. This leads to lower power dissipations such that for many applications a heat sink is not required. Standard features include output voltage trim, remote sense, on/off control, output overcurrent and over voltage protection, over temperature protection, input under and over voltage lockout, power good signal and PMBus interface.

The output is fully isolated from the input, allowing versatile polarity configurations and grounding connections. Built-in filtering for both input and output minimizes the need for external filtering.

* UL is a registered trademark of Underwriters Laboratories, Inc.

† CSA is a registered trademark of Canadian Standards Association.

‡ VDE is a trademark of Verband Deutscher Elektrotechniker e.V.

§ This product is intended for integration into end-user equipment. All of the required procedures of end-use equipment should be followed.

Absolute Maximum Ratings

Stresses in excess of the absolute maximum ratings can cause permanent damage to the device. These are absolute stress ratings only, functional operation of the device is not implied at these or any other conditions in excess of those given in the operations sections of the Data Sheet. Exposure to absolute maximum ratings for extended periods can adversely affect device reliability.

Parameter	Device	Symbol	Min	Max	Unit
Input Voltage*					
Continuous		V _{IN}	-0.3	75	V _{dc}
Operating transient ≤ 100mS				100	V _{dc}
Operating Input transient slew rate, 50V _{IN} to 75V _{IN} (Output may exceed regulation limits, no protective shutdowns shall activate, C _O =220μF to C _{O,max})		-	-	12.5	V/μs
Non- operating continuous		V _{IN}	80	100	V _{dc}
Operating Ambient Temperature (See Thermal Considerations section)	All	T _A	-40	85	°C
Storage Temperature	All	T _{stg}	-55	125	°C
I/O Isolation Voltage (100% factory Hi-Pot tested)	All	—	—	2250	V _{dc}

* Input over voltage protection will shutdown the output voltage when the input voltage exceeds threshold level.

Electrical Specifications

Unless otherwise indicated, specifications apply over all operating input voltage, resistive load, and temperature conditions.

Parameter	Device	Symbol	Min	Typ	Max	Unit
Operating Input Voltage		V _{IN}	36	48	75	V _{dc}
Maximum Input Current (V _{IN} =0V to 75V, I _O =I _{O,max})		I _{IN,max}	-	-	12	A _{dc}
Input No Load Current (V _{IN} = V _{IN,nom} , I _O = 0, module enabled)	All	I _{IN,No load}		50		mA
Input Stand-by Current (V _{IN} = V _{IN,nom} , module disabled)	All	I _{IN,stand-by}			10	mA
Inrush Transient	All	I ² t	-	-	1	A ² s
Input Reflected Ripple Current, peak-to-peak (5Hz to 20MHz, 12μH source impedance; V _{IN} = 48V, I _O = I _{O,max} ; see Figure 10)	All		-	24	-	mA _{p-p}
Input Ripple Rejection (120Hz)	All		-	50	-	dB

CAUTION: This power module is not internally fused. An input line fuse must always be used.

This power module can be used in a wide variety of applications, ranging from simple standalone operation to an integrated part of sophisticated power architecture. To preserve maximum flexibility, internal fusing is not included, however, to achieve maximum safety and system protection, always use an input line fuse. The safety agencies require a fast-acting fuse with a maximum rating of TBD A (see Safety Considerations section). Based on the information provided in this Data Sheet on inrush energy and maximum dc input current, the same type of fuse with a lower rating can be used. Refer to the fuse manufacturer's Data Sheet for further information.

Electrical Specifications (continued)

Parameter	Device	Symbol	Min	Typ	Max	Unit
Output Voltage Set-point (V _{IN} =V _{IN,nom} , I _O =15A, T _A =25°C)	All	V _{O,set}	11.84	12	12.12	V _{dc}
Output Voltage (Over all operating input voltage, resistive load, and temperature conditions until end of life)		V _O	-3.0	—	+3.0	% V _{O,set}
Output Regulation						
Line (V _{IN} =V _{IN,min} to V _{IN,max})	All		—	—	0.2	% V _{O,set}
Load (I _O =I _{O,min} to I _{O,max})	All		—	—	0.2	% V _{O,set}
Temperature (T _A = -40°C to +85°C)	All		—	—	1.0	% V _{O,set}
Output Voltage Adjustment Range (via Trim resistor or PMBus)	All		8.1		13.2	V _{dc}
Output Ripple and Noise on nominal output (V _{IN} =V _{IN,nom} and I _O =I _{O,min} to I _{O,max})						
RMS (5Hz to 20MHz bandwidth)	All		—	70	—	mV _{rms}
Peak-to-Peak (5Hz to 20MHz bandwidth)	All		—	200	—	mV _{pk-pk}
External Output Capacitance	All	C _{O,max}	220	—	10,000	μF
Output Current	All	I _O	0		33	A _{dc}
Output Current Limit Inception (Adjustable via PMBus)	All	I _{O,lim}	—	40	—	A _{dc}
Efficiency (V _{IN} =V _{IN,nom} , V _O = V _{O,set} , T _A =25°C) I _O = 50% I _{O,max} I _O = 100% I _{O,max}	All	η η		96 95		% %
Switching Frequency		f _{sw}		TBD		kHz
Dynamic Load Response (dI _O /dt=1A/10μs; V _{in} =V _{in,nom} ; T _A =25°C; Tested with a 10 μF aluminum and a 1.0 μF tantalum capacitor across the load.)						
Load Change from I _O = 50% to 75% of I _{O,max} : Peak Deviation Settling Time (V _O <10% peak deviation)	All	V _{pk} t _s	— —	300 700	— —	mV _{pk} μs
Load Change from I _O = 75% to 50% of I _{O,max} : Peak Deviation Settling Time (V _O <10% peak deviation)		V _{pk} t _s	— —	300 700	— —	mV _{pk} μs

Isolation Specifications

Parameter	Symbol	Min	Typ	Max	Unit
Isolation Capacitance	C _{iso}	—	1000	—	pF
Isolation Resistance	R _{iso}	10	—	—	MΩ

General Specifications

Parameter	Device	Min	Typ	Max	Unit
Calculated Reliability Based upon Telcordia SR-332 Issue 2: Method I, Case 1, (I _O =80%I _{O,max} , T _A =40°C, Airflow = 200 lfm), 90% confidence	MTBF	All	TBD		Hours
	FIT	All	TBD		10 ⁹ /Hours
Weight – Open Frame		—	TBD	—	g (oz.)
Weight – with Baseplate option		—	TBD	—	g (oz.)

Feature Specifications

Unless otherwise indicated, specifications apply over all operating input voltage, resistive load, and temperature conditions. See Feature Descriptions for additional information.

Parameter	Device	Symbol	Min	Typ	Max	Unit
<p>Remote On/Off Signal Interface (V_{IN}=V_{IN,min} to V_{IN,max}, Signal referenced to V_{IN}-terminal) Negative Logic: device code suffix "1" Logic Low = module On, Logic High = module Off Positive Logic: No device code suffix required Logic Low = module Off, Logic High = module On Logic Low Specification On/Off Thresholds:</p>						
Remote On/Off Current – Logic Low	All	I _{on/off}	5	10	15	μA
Logic Low Voltage	All	V _{on/off}	-0.3	—	0.8	V _{dc}
Logic High Voltage – (Typ = Open Collector)	All	V _{on/off}	2.0	—	3.5	V _{dc}
Logic High maximum allowable leakage current (V _{on/off} = 2.0V)	All	I _{on/off}	—	—	4.0	μA
Maximum voltage allowed on On/Off pin	All	V _{on/off}	—	—	13.5	V _{dc}
<p>Turn-On Delay and Rise Times (I_O=I_{O,max}) (Adjustable via PMBus)</p>						
T _{delay} = Time until V _O = 10% of V _{O,set} from either application of Vin with Remote On/Off set to On or operation of Remote On/Off from Off to On with Vin already applied for at least one second.	All	T _{delay, Enable with Vin}	—	TBD	—	ms
	All	T _{delay, Enable with on/off}	—	TBD	—	ms
T _{rise} = Time for V _O to rise from 10% of V _{O,set} to 90% of V _{O,set} . (Adjustable via PMBus)		T _{rise}	—	TBD	—	ms
Output Overvoltage Protection (Adjustable via PMBus)	All		13	—	17	V _{dc}
Overtemperature Protection (Adjustable via PMBus) (See Feature Descriptions) (Default)	All	T _{ref}	—	TBD	—	°C
Input Undervoltage Lockout (Adjustable via PMBus)						
Turn-on Threshold (Default)			—	34.5	36	V _{dc}
Turn-off Threshold (Default)			31	31.5	—	V _{dc}
Input Overvoltage Lockout (Adjustable via PMBus)						
Turn-off Threshold (Default)			—	81	82	V _{dc}
Turn-on Threshold (Default)			78	79	—	V _{dc}

Characteristic Curves

The following figures provide typical characteristics for the QBDW033A0B (12V, 33A) at 25°C. The figures are identical for either positive or negative Remote On/Off logic.

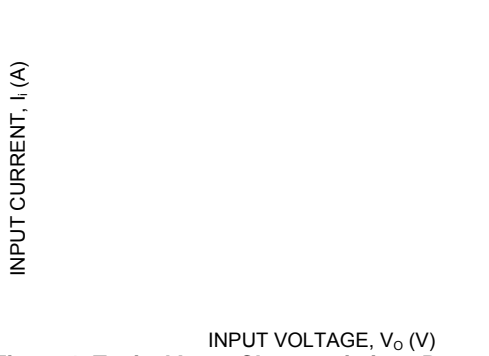

Figure 1. Typical Input Characteristic at Room Temperature.

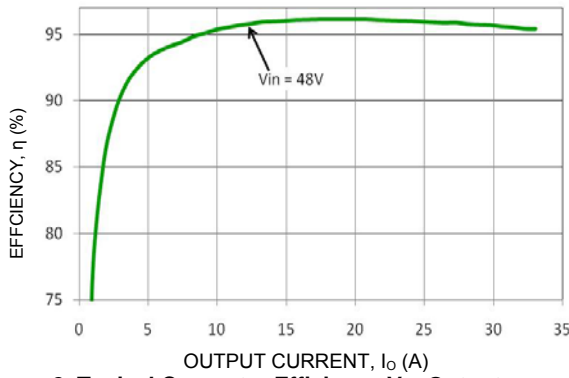

Figure 2. Typical Converter Efficiency Vs. Output current at Room Temperature.

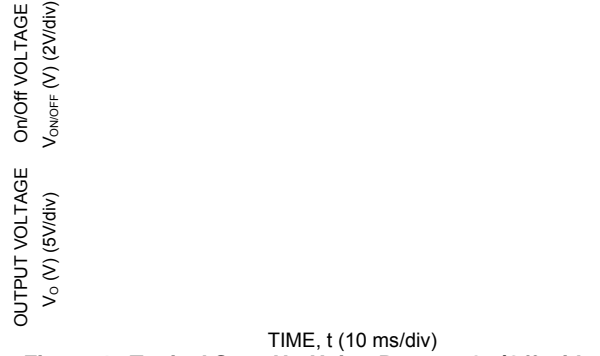

Figure 4. Typical Start-Up Using Remote On/Off with Vin applied, negative logic version shown.



Figure 5. Typical Transient Response to Step change in Load from 25% to 50% to 25% of Full Load at Room Temperature and 48 Vdc Input.



Figure 3. Typical Start-Up Using Vin with Remote On/Off enabled, negative logic version shown.

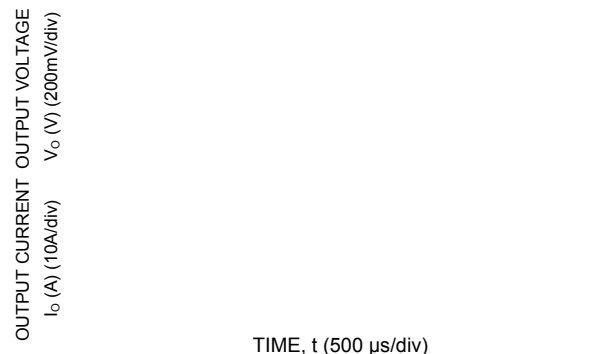

Figure 6. Typical Transient Response to Step Change in Load from 50% to 75% to 50% of Full Load at Room Temperature and 48 Vdc Input.

Characteristic Curves (continued)

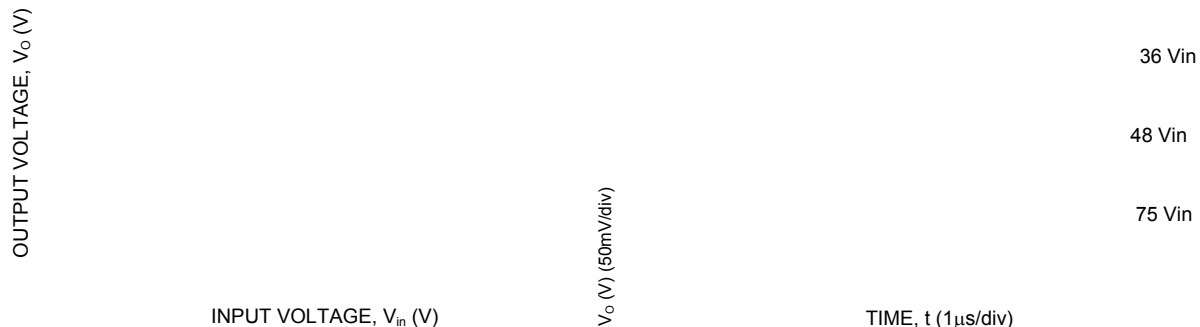

Figure 7. Typical Output Voltage regulation vs. Input Voltage at Room Temperature.

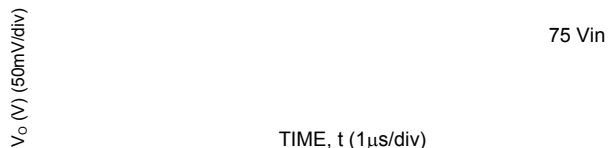

Figure 9. Typical Output Ripple and Noise at Room Temperature and $I_o = I_{o,max}$.

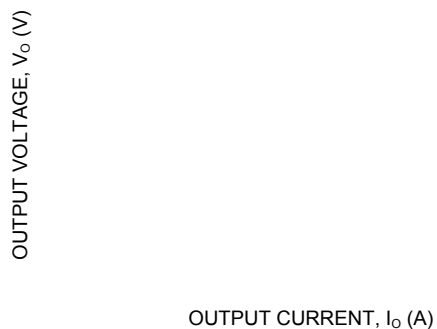
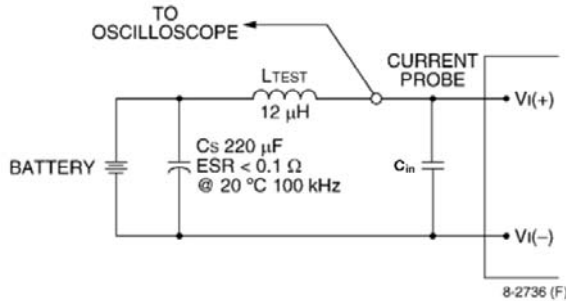

Figure 8. Typical Output Voltage Regulation vs. Output Current at Room Temperature.

Test Configurations



Note: Measure input reflected-ripple current with a simulated source inductance (LTEST) of 12 µH. Capacitor CS offsets possible battery impedance. Measure current as shown above.

Figure 10. Input Reflected Ripple Current Test Setup.

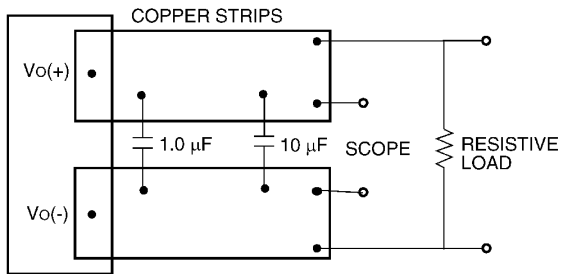

Note: Use a 1.0 µF ceramic capacitor and a 10 µF aluminum or tantalum capacitor. Scope measurement should be made using a BNC socket. Position the load between 51 mm and 76 mm (2 in. and 3 in.) from the module.

Figure 11. Output Ripple and Noise Test Setup.

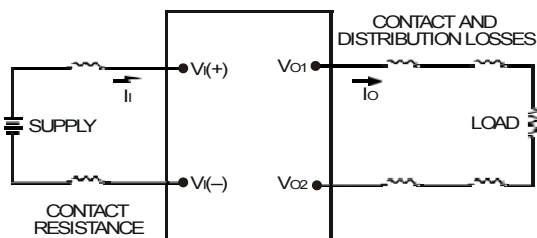

Note: All measurements are taken at the module terminals. When socketing, place Kelvin connections at module terminals to avoid measurement errors due to socket contact resistance.

$$\eta = \left(\frac{[V_{O(+)} - V_{O(-)}]I_O}{[V_{I(+)} - V_{I(-)}]I_I} \right) \times 100 \%$$

Figure 12. Output Voltage and Efficiency Test Setup.

Design Considerations

Input Source Impedance

The power module should be connected to a low ac-impedance source. A highly inductive source impedance can affect the stability of the power module. For the test configuration in Figure 10, a 330µF electrolytic capacitor, C_{in}, (ESR<0.7Ω at 100kHz), mounted close to the power module helps ensure the stability of the unit. If the module is subjected to rapid on/off cycles, a 330µF input capacitor is required. Consult the factory for further application guidelines.

Safety Considerations

For safety-agency approval of the system in which the power module is used, the power module must be installed in compliance with the spacing and separation requirements of the end-use safety agency standard, i.e., UL60950-1, CSA C22.2 No. 60950-1, and VDE EN60950-1.

If the input source is non-SELV (ELV or a hazardous voltage greater than 60 Vdc and less than or equal to 75Vdc), for the module's output to be considered as meeting the requirements for safety extra-low voltage (SELV), all of the following must be true:

- The input source is to be provided with reinforced insulation from any other hazardous voltages, including the ac mains.
- One V_{IN} pin and one V_{OUT} pin are to be grounded, or both the input and output pins are to be kept floating.
- The input pins of the module are not operator accessible.
- Another SELV reliability test is conducted on the whole system (combination of supply source and subject module), as required by the safety agencies, to verify that under a single fault, hazardous voltages do not appear at the module's output.

Note: Do not ground either of the input pins of the module without grounding one of the output pins. This may allow a non-SELV voltage to appear between the output pins and ground.

The power module has safety extra-low voltage (SELV) outputs when all inputs are SELV.

The input to these units is to be provided with a maximum TBD A fast-acting (or time-delay) fuse in the unearthed lead.

Feature Descriptions

OverCurrent Protection

To provide protection in a fault output overload condition, the module is equipped with internal current-limiting circuitry and can endure current limiting continuously. If the OverCurrent (IOUT_OC) condition causes the output voltage to fall below $tbdV$, the module will shut down and remain latched off. The overcurrent latch is reset by either cycling the input power or by toggling the on/off pin for one second. If the output overload condition still exists when the module restarts, it will shut down again. This operation will continue indefinitely until the overcurrent condition is corrected.

A factory configured auto-restart option is also available. An auto-restart feature continually attempts to restore the operation until fault condition is cleared.

The IOUT_OC_WARNING and FAULT threshold levels, and IOUT_OC_FAULT_RESPONSE can be reconfigured via the PMBus interface.

Remote On/Off [CONTROL](i)

The module contains a standard on/off control circuit reference to the $V_{IN(-)}$ terminal. Two factory configured remote on/off logic options are available. Positive logic remote on/off turns the module on during a logic-high voltage on the ON/OFF(i) pin, and off during a logic low. Negative logic remote on/off turns the module off during a logic high, and on during a logic low. Negative logic, device code suffix "1," is the factory-preferred configuration. The On/Off(i) circuit is powered from an internal bias supply, derived from the input voltage terminals. To turn the power module on and off, the user must supply a switch to control the voltage between the On/Off(i) terminal and the $V_{IN(-)}$ terminal ($V_{on/off(i)}$). The switch can be an open collector or equivalent (see Figure 13). A logic low is $V_{on/off(i)} = -0.3V$ to $0.8V$. The typical $I_{on/off(i)}$ during a logic low is $TBD\mu A$. The switch should maintain a logic-low voltage while sinking $TBD\mu A$. During a logic high, the maximum $V_{on/off(i)}$ generated by the power module is $TBDV$. The maximum allowable leakage current of the switch at $V_{on/off(i)} = 2.0V$ is $TBD\mu A$. If using an external voltage source, the maximum voltage $V_{on/off(i)}$ on the pin is $TBDV$ with respect to the $V_{IN(-)}$ terminal.

If not using the remote on/off feature, perform one of the following to turn the unit on:

For negative logic, short ON/OFF(i) pin to $V_{IN(-)}$.

For positive logic: leave ON/OFF(i) pin open.

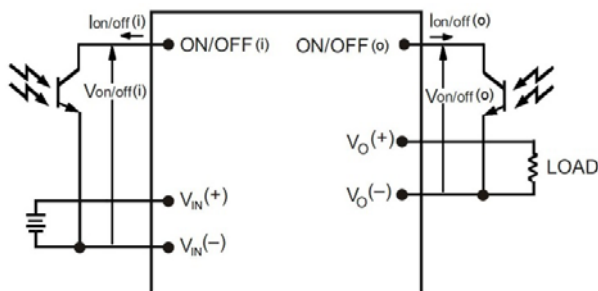

Figure 13. Remote On/Off Implementation.

LINEAGE POWER

Remote On/Off [CONTROL](o)

The module contains an configurable on/off control circuit reference to the $V_{O(-)}$ terminal. Two factory configured remote on/off logic options are available. Positive logic remote on/off turns the module on during a logic-high voltage on the ON/OFF pin, and off during a logic low. Negative logic remote on/off turns the module off during a logic high, and on during a logic low. The logic of the ON/OFF(o) pin shall match the logic of the ON/OFF(i) pin. Negative logic, device code suffix "1," is the factory-preferred configuration. The On/Off(o) circuit is powered from an internal bias supply, derived from the output bias voltage. To turn the power module on and off, the user must supply a switch to control the voltage between the On/Off (o) terminal and the $V_{O(-)}$ terminal ($V_{on/off(o)}$). The switch can be an open collector or equivalent (see Figure 13). A logic low is $V_{on/off(o)} = -0.3V$ to $0.8V$. The typical $I_{on/off(o)}$ during a logic low is $TBD\mu A$. The switch should maintain a logic-low voltage while sinking $TBD\mu A$. During a logic high, the maximum $V_{on/off(o)}$ generated by the power module is $TBDV$. The maximum allowable leakage current of the switch at $V_{on/off(o)} = 2.0V$ is $TBD\mu A$. If using an external voltage source, the maximum voltage $V_{on/off(o)}$ on the pin is $TBDV$ with respect to the $V_{i(-)}$ terminal.

If not using the remote on/off feature, perform one of the following to turn the unit on:

For negative logic, short ON/OFF(o) pin to $V_{i(-)}$.

For positive logic: leave ON/OFF(o) pin open.

When both On/Off(i) and On/Off(o) are present, the module shall operate if either is asserted. Using Mfgr_Specif commands, it shall be possible to reconfigure the On/Off logic between positive and negative via PMBus, and it shall also be possible to reconfigure the combination of On/Off(i) and On/Off(o) from OR to AND for module operation.

Output Overvoltage Protection

The output overvoltage protection consists of a control circuit, independent of the primary regulation loop, that monitors the voltage on the output terminals and clamps the voltage when it exceeds the overvoltage set point. The control loop of the clamp has a higher voltage set point than the primary loop. This provides a redundant voltage control that reduces the risk of output overvoltage.

Overtemperature Protection

These modules feature an overtemperature protection circuit to safeguard against thermal damage. The circuit shuts down and latches off the module when the maximum device reference temperature is exceeded. The module can be restarted by cycling the dc input power for at least one second or by toggling the remote on/off signal for at least one second.

Input Under/Over voltage Lockout

At input voltages above or below the input under/over voltage lockout limits, module operation is disabled. The module will begin to operate when the input voltage level changes to within the under and overvoltage lockout limits.

Feature Descriptions (continued)

Remote Sense

Remote sense minimizes the effects of distribution losses by regulating the voltage at the remote-sense connections (See Figure 11). The voltage between the remote-sense pins and the output terminals must not exceed the output voltage sense range given in the Feature Specifications table:

$$[V_{O(+)} - V_{O(-)}] - [SENSE(+)- SENSE(-)] \leq 0.5 \text{ V}$$

Although the output voltage can be increased by both the remote sense and by the trim, the maximum increase for the output voltage is not the sum of both. The maximum increase is the larger of either the remote sense or the trim.

The amount of power delivered by the module is defined as the voltage at the output terminals multiplied by the output current. When using remote sense and trim, the output voltage of the module can be increased, which at the same output current would increase the power output of the module. Care should be taken to ensure that the maximum output power of the module remains at or below the maximum rated power (Maximum rated power = $V_{o,set} \times I_{o,max}$).

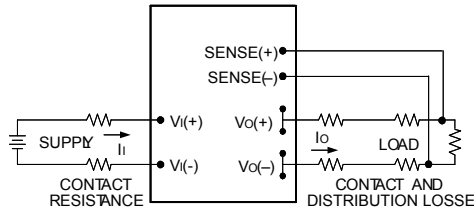

Figure 11. Circuit Configuration for remote sense

Configurable Control Pins

The QBDW033A0B contains two configurable control pins, T/C1 and C2, referenced to the module secondary SIGGND. See Mechanical Views for pin locations. The following table list the available factory configurations for the functions assigned to these pins. Additional configurations can accomplished via the PMBus interface. Following the tables, there is a feature description for each function.

Pin Designation/Function		Factory Configuration
T/C1	C2	
Trim TM	Power Good PG	Modules without -P
Load Share CS	Power Good PG	Modules with -P

C2 Pin Designation/Function Configurable via PMBus
Power Good PG
On/Off(o)

Trim, Output Voltage Programming, TM

Trimming allows the output voltage set point to be increased or decreased; this is accomplished by connecting an external resistor between the TRIM pin and either the V_O(+) pin or the V_O(-) pin.

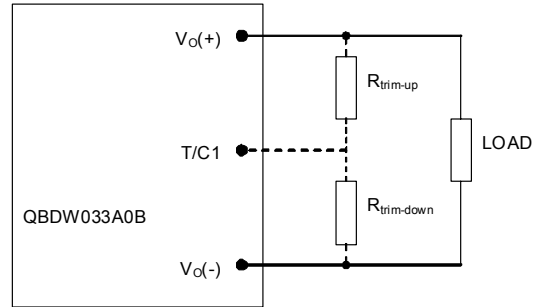

Figure 12. Circuit Configuration to Trim Output Voltage.

Connecting an external resistor ($R_{trim-down}$) between the T/C1 pin and the V_O(-) (or Sense(-)) pin decreases the output voltage set point. To maintain set point accuracy, the trim resistor tolerance should be $\pm 1.0\%$.

The following equation determines the required external resistor value to obtain a percentage output voltage change of $\Delta\%$

$$R_{trim-down} = \left[\frac{511}{\Delta\%} - 10.22 \right] \text{K}\Omega$$

Where $\Delta\% = \left(\frac{V_{o,set} - V_{desired}}{V_{o,set}} \right) \times 100$

For example, to trim-down the output voltage of the module by 20% to 9.6V, $R_{trim-down}$ is calculated as follows:

$$\Delta\% = 20$$

$$R_{trim-down} = \left[\frac{511}{20} - 10.22 \right] \text{K}\Omega$$

$$R_{trim-down} = 15.3 \text{K}\Omega$$

Connecting an external resistor ($R_{trim-up}$) between the T/C1 pin and the V_O(+) (or Sense (+)) pin increases the output voltage set point. The following equations determine the required external resistor value to obtain a percentage output voltage change of $\Delta\%$:

$$R_{trim-up} = \left[\frac{5.11 \times V_{o,set} \times (100 + \Delta\%)}{1.225 \times \Delta\%} - \frac{511}{\Delta\%} - 10.22 \right] \text{K}\Omega$$

Where $\Delta\% = \left(\frac{V_{desired} - V_{o,set}}{V_{o,set}} \right) \times 100$

For example, to trim-up the output voltage of the module by 5% to 12.6V, $R_{trim-up}$ is calculated is as follows:

$$\Delta\% = 5$$

$$R_{trim-up} = \left[\frac{5.11 \times 12.0 \times (100 + 5)}{1.225 \times 5} - \frac{511}{5} - 10.22 \right] \text{K}\Omega$$

$$R_{trim-up} = 102.2 \text{K}\Omega$$

Feature Descriptions (continued)

The voltage between the Vo(+) and Vo(-) terminals must not exceed the minimum output overvoltage protection value shown in the Feature Specifications table. This limit includes any increase in voltage due to remote-sense compensation and output voltage set-point adjustment trim.

Although the output voltage can be increased by both the remote sense and by the trim, the maximum increase for the output voltage is not the sum of both. The maximum increase is the larger of either the remote sense or the trim. The amount of power delivered by the module is defined as the voltage at the output terminals multiplied by the output current. When using remote sense and trim, the output voltage of the module can be increased, which at the same output current would increase the power output of the module. Care should be taken to ensure that the maximum output power of the module remains at or below the maximum rated power (Maximum rated power = $V_{O,set} \times I_{O,max}$).

Active Load Sharing, CS

For additional power requirements, the QBDW033A0B power module can be configured for parallel operation with active load sharing. Good layout techniques should be observed for noise immunity when using multiple units in parallel. To implement active load sharing, the following requirements should be followed:

- The Vout(+) and Vout(-) planes of all parallel modules must be connected together with output traces from each module as short as possible to common power planes.
- The SENSE(+) and SENSE(-) connections to each module should come from a single point in each power plane.
- The current share (CS) pins of all units in parallel must be connected together. The path of these connections should be as direct as possible. SIGGND is the return for the CS signal for each module; therefore, all modules in parallel must use the same SIGGND.
- These modules contain circuitry to block reverse current flow upon start-up, when output voltage is present from other parallel modules, eliminating the requirement for external output ORing devices. However, output ORing devices should be used, if fault tolerance is desired in parallel applications.
- When not using the parallel feature, leave the CS open.

Power Good, PG

The QBDW033A0B modules provide a Power Good (PG) signal that is implemented with an open-drain output to indicate that the output voltage is within the regulation limits of the power module. The PG signal will be de-asserted to a low state if any condition such as overtemperature, overcurrent or loss of regulation occurs that would result in the output voltage going \pm TBD% outside the setpoint value. The PG terminal should be connected through a pullup resistor (suggested value TBDK Ω) to a source of TBDV_{dc} or less.

Thermal Considerations

The power modules operate in a variety of thermal environments and sufficient cooling should be provided to help ensure reliable operation.

Thermal considerations include ambient temperature, airflow, module power dissipation, and the need for increased reliability. A reduction in the operating temperature of the module will result in an increase in reliability. The thermal data presented here is based on physical measurements taken in a wind tunnel.

Heat-dissipating components are mounted on the top side of the module. Heat is removed by conduction, convection and radiation to the surrounding environment. Proper cooling can be verified by measuring the thermal reference temperature (TH_x). Peak temperature (TH_x) occurs at the position indicated in Figure 14 and 15. For reliable operation this temperature should not exceed the listed temperature threshold.

Figure 14. Location of the thermal reference temperature TH.

Figure 15. Location of the thermal reference temperature TH₃ for Baseplate module.

Feature Descriptions (continued)

The output power of the module should not exceed the rated power for the module as listed in the Ordering Information table.

Although the maximum TH_x temperature of the power modules is 110 °C - 125 °C, you can limit this temperature to a lower value for extremely high reliability.

Please refer to the Application Note "Thermal Characterization Process For Open-Frame Board-Mounted Power Modules" for a detailed discussion of thermal aspects including maximum device temperatures.

Heat Transfer via Convection

Increased airflow over the module enhances the heat transfer via convection. The thermal derating of figure 16 shows the maximum output current that can be delivered by each module in the indicated orientation without exceeding the maximum TH_x temperature versus local ambient temperature (T_A) for air flows of, Natural Convection, 1 m/s (200 ft./min), 2 m/s (400 ft./min).

The use of Figures 16 is shown in the following example:

Example

What is the minimum airflow necessary for a QBDW033A0B operating at V_I = 48 V, an output current of 22A, and a maximum ambient temperature of 70 °C in transverse orientation.

Solution:

Given: V_{in} = 48V, I_o = 22A, T_A = 70 °C

Determine required airflow (V) (Use Figure 16):

V = tbd or greater.

OUTPUT CURRENT, I_o (A)

LOCAL AMBIENT TEMPERATURE, T_A (°C)

Figure 16. Output Current Derating for the Open Frame QBDW033A0B in the Transverse Orientation; Airflow Direction from Vin(+) to Vin(-); Vin = 48V.

Layout Considerations

The QBDW033 power module series are low profile in order to be used in fine pitch system card architectures. As such, component clearance between the bottom of the power module and the mounting board is limited. Avoid placing copper areas on the outer layer directly underneath the power module. Also avoid placing via interconnects underneath the power module.

For additional layout guide-lines, refer to FLTR100V10 Data Sheet.

Through-Hole Lead-Free Soldering Information

The RoHS-compliant, Z version, through-hole products use the SAC (Sn/Ag/Cu) Pb-free solder and RoHS-compliant components. The non-Z version products use lead-tin (Pb/Sn) solder and RoHS-compliant components. Both version modules are designed to be processed through single or dual wave soldering machines. The pins have an RoHS-compliant, pure tin finish that is compatible with both Pb and Pb-free wave soldering processes. A maximum preheat rate of 3°C/s is suggested. The wave preheat process should be such that the temperature of the power module board is kept below 210°C. For Pb solder, the recommended pot temperature is 260°C, while the Pb-free solder pot is 270°C max. Not all RoHS-compliant through-hole products can be processed with paste-through-hole Pb or Pb-free reflow process. If additional information is needed, please consult with your Lineage Power representative for more details.

Post Solder Cleaning and Drying Considerations

Post solder cleaning is usually the final circuit-board assembly process prior to electrical board testing. The result of inadequate cleaning and drying can affect both the reliability of a power module and the testability of the finished circuit-board assembly. For guidance on appropriate soldering, cleaning and drying procedures, refer to Lineage Power *Board Mounted Power Modules: Soldering and Cleaning* Application Note (AP01-056EPS).

PMBus

The QBDW033A0B series is equipped with a digital PMBus interface to allow the module to be configured, and

communicate with system controllers. Detailed timing and electrical characteristics of the PMBus can be found in the PMB Power Management Protocol Specification, Part 1, revision 1.1, available at <http://pmbus.org>. The QBDW033A0B supports both the 100kHz and 400kHz bus timing requirements. The QBDW033A0B is permitted to stretch the clock, as long as it does not exceed the maximum clock LO period of 35ms. All communication over the QBDW033A0B device PMBus interface is required to support the Packet Error Checking (PEC) scheme. The PMBus master must generate the correct PEC byte for all transactions and check the PEC byte returned by the QBDW033A0B.

The QBDW033A0B supports a subset of the commands in the PMBus 1.1 specification. Most all of the controller parameters can be programmed using the PMBus and stored as defaults for later use. All commands that require data input or output use the linear format. The exponent of the data words is fixed at a reasonable value for the command and altering the exponent is not supported. Direct format data input or output is not supported by the QBDW033A0B. The supported commands are described in greater detail below.

The QBDW033A0B also supports the SMBALERT response protocol. The SMBALERT response protocol is a mechanism by which a slave (the QBDW033A0B) can alert the bus master that it wants to talk. The master processes this event and simultaneously addresses all slaves on the bus (that support the protocol) through the alert response address. Only the slave(s) that caused the alert acknowledges this request. The host performs a modified receive byte operation to get the slave's address. At this point, the master can use the PMBus status commands to query the slave that caused the alert. For more information on the SMBus alert response protocol, see the System Management Bus (SMBus) specification.

The QBDW033A0B contains non-volatile memory that is used to store configuration settings and scale factors. The settings programmed into the device are not automatically saved into this non-volatile memory though. The STORE_DEFAULT_ALL command must be used to commit the current settings to non-volatile memory as device defaults. The settings that are capable of being stored in non-volatile memory are noted in their detailed descriptions.

Supported PMBus Commands

Memory PMBus Management

Cmd Code	Command Name	Transaction Type	Number of Data Bytes	Data Description	Access	Min	Max	Default	Resolution	Steps	Units
0 3 h	CLEAR_FAULTS	Send Byte	0								
1 1 h	STORE_DEFAULT_ALL	Send Byte	0								
1 2 h	RESTORE_DEFAULT_ALL	Send Byte	0								
7 9 h	STATUS_WORD	Read Word	2								
7 E h	STATUS_CML	Read Byte	1								
F 0 h	MFR_MODULE_DATE_LOC_SN	Read Word	2								

Output Voltage PMBus Management

Cmd Code	Command Name	Transaction Type	Number of Data	Data Description	Access	Min	Max	Default	Resolution	Steps	Units
0 1 h	OPERATION	R/W Byte	1		CUSTOMER R/W						
0 2 h	ON_OFF_CONFIG	R/W Byte	1		CUSTOMER R/W						
2 1 h	VOUT_COMMAND	R/W Word	2	Linear	CUSTOMER R/W						V
2 3 h	VOUT_CAL_OFFSET	R/W Word	2	Linear	FACTORY R/W ONLY						V
2 5 h	VOUT_MARGIN_HIGH	R/W Word	2	Linear	CUSTOMER R/W						V
2 6 h	VOUT_MARGIN_LOW	R/W Word	2	Linear	CUSTOMER R/W						V
2 8 h	VOUT_DROOP	R/W Word	2	Linear	CUSTOMER R/W						mV/A (m?)
4 0 h	VOUT_OV_FAULT_LIMIT	R/W Word	2	Linear	CUSTOMER R/W						V
4 1 h	VOUT_OV_FAULT_RESPONSE	R/W Byte	1		CUSTOMER R/W						
6 0 h	TON_DELAY	R/W Word	2	Linear	CUSTOMER R/W						mS
6 1 h	TON_RISE	R/W Word	2	Linear	CUSTOMER R/W						mS
7 A h	STATUS_VOUT	Read Byte	1								
8 B h	READ_VOUT	Read Word	2								
D 0 h	MFR_VOUT_READ_CAL_GAIN	R/W Word	2								
D 1 h	MFR_VOUT_READ_CAL_OFFSET	R/W Word	2								
D 4 h	MFR_LOOP_COMP_BREAKS	R/W Word	2								
E 1 h	MFR_MULTI_ON_OFF_PIN_CONFIG	R/W Word	2								

Input Voltage PMBus Management

Cmd Code	Command Name	Transaction Type	Number of Data	Data Description	Access	Min	Max	Default	Resolution	Steps	Units
3 5 h	VIN_ON	R/W Word	2	Linear							V
3 6 h	VIN_OFF	R/W Word	2	Linear							V
5 5 h	VIN_OV_FAULT_LIMIT	R/W Word	2	Linear							V
5 6 h	VIN_OV_FAULT_RESPONSE	R/W Byte	1			10.5.1. Response To Voltage					
7 C h	STATUS_INPUT	Read Byte	1								
8 8 h	READ_VIN	Read Word	2								
D 2 h	MFR_VIN_READ_CAL_GAIN	R/W Word	2								
D 3 h	MFR_VIN_READ_CAL_OFFSET	R/W Word	2								

Output Current PMBus Management

Cmd Code	Command Name	Transaction Type	Number of Data	Data Description	Access	Min	Max	Default	Resolution	Steps	Units
4 6 h	IOUT_OC_FAULT_LIMIT	R/W Word	2	Linear							
4 7 h	IOUT_OC_FAULT_RESPONSE	R/W Byte	1			10.5.1. Response To Voltage					
4 A h	IOUT_OC_WARN_LIMIT	R/W Word	2	Linear							
7 B h	STATUS_IOUT	Read Byte	1								
8 C h	READ_IOUT	Read Word	2								

Temperature Protection PMBus Management

Cmd Code	Command Name	Transaction Type	Number of Data	Data Description	Access	Min	Max	Default	Resolution	Steps	Units
4 F h	OT_FAULT_LIMIT	R/W Word	2	Linear							C
5 0 h	OT_FAULT_RESPONSE	R/W Byte	1			10.5.1. Response To Voltage					
5 1 h	OT_WARN_LIMIT	R/W Word	2	Linear							C
7 D h	STATUS_TEMPERATURE_1	Read Byte	1								
8 D h	READ_TEMPERATURE_1	Read Word	2								

Power Good PMBus Management

Cmd Code	Command Name	Transaction Type	Number of Data	Data Description	Access	Min	Max	Default	Resolution	Steps	Units
5 E h	POWER_GOOD_ON	R/W Word	2								
5 F h	POWER_GOOD_OFF	R/W Word	2								
E 0 h	MFR_MULTI_PIN_CONFIG	R/W Byte	1								
E 2 h	MFR_POWER_GOOD_POLARITY	R/W Byte	1								

Mechanical Outline for QBDW033A0B Through-hole Module

Dimensions are in millimeters and [inches].

Tolerances: x.x mm ± 0.5 mm [x.xx in. ± 0.02 in.] (Unless otherwise indicated)

x.xx mm ± 0.25 mm [x.xxx in ± 0.010 in.]

*Top side label includes Lineage Power name, product designation, and data code.

** Standard pin tail length. Optional pin tail lengths shown in Table 2, Device Options.

TOP VIEW*

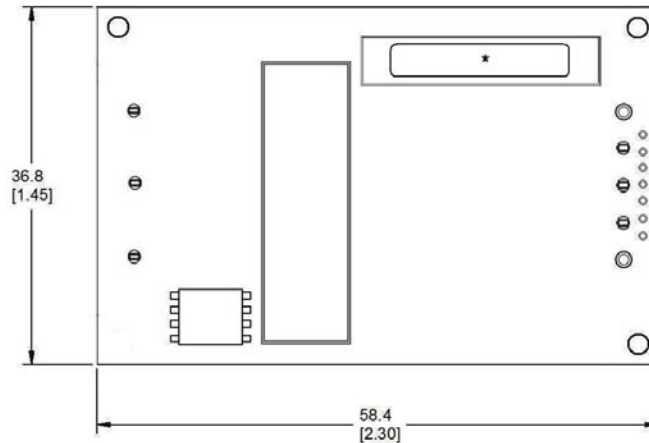

SIDE VIEW

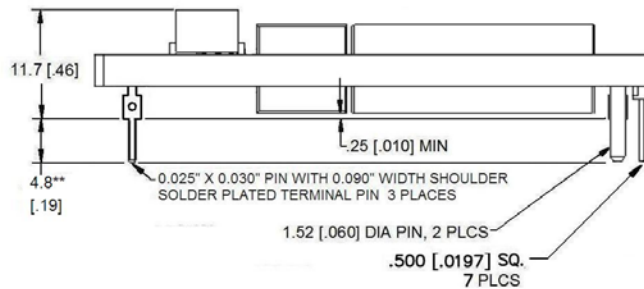

BOTTOM VIEW

Pin Number	Pin Name
1	VIN(+)
2	ON/OFF
3	VIN(-)
4	VOU(-)
5	SENSE(-)
6	TRIM/C1
7	SENSE(+)
8	VOU(+)
9	C2
10	SIG_GND
11	DATA
12	SMBALERT
13	CLK
14	ADDR1
15	ADDR0

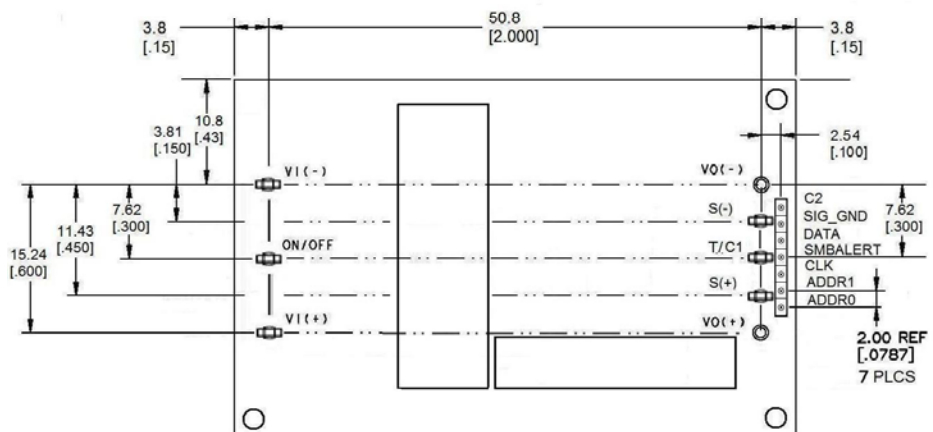

Mechanical Outline for QBDW033A0B-H (Baseplate version) Module

Dimensions are in millimeters and [inches].

Tolerances: x.x mm ± 0.5 mm [x.xx in. ± 0.02 in.] (Unless otherwise indicated)

x.xx mm ± 0.25 mm [x.xxx in ± 0.010 in.]

*Side label includes product designation, and data code.

** Standard pin tail length. Optional pin tail lengths shown in Table 2, Device Options.

***Bottom label includes Lineage Power name, product designation, and data code

TOP VIEW

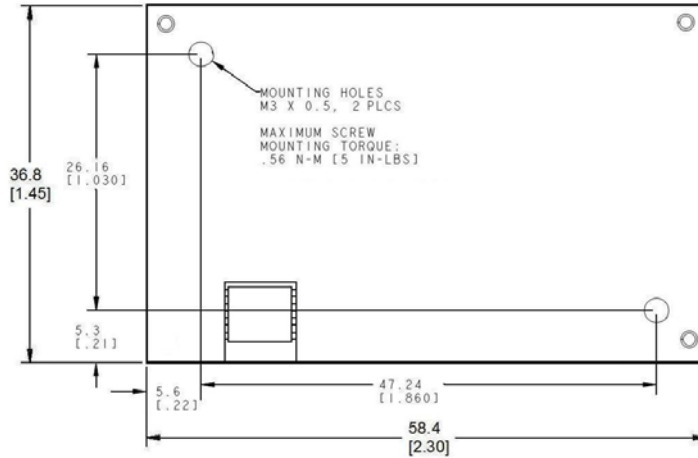

SIDE VIEW*

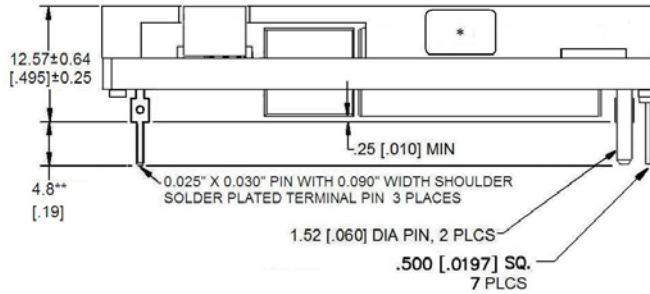

BOTTOM VIEW***

Pin Number	Pin Name
1	VIN(+)
2	ON/OFF
3	VIN(-)
4	VOUT(-)
5	SENSE(-)
6	TRIM/C1
7	SENSE(+)
8	VOUT(+)
9	C2
10	SIG_GND
11	DATA
12	SMBALERT
13	CLK
14	ADDR1
15	ADDR0

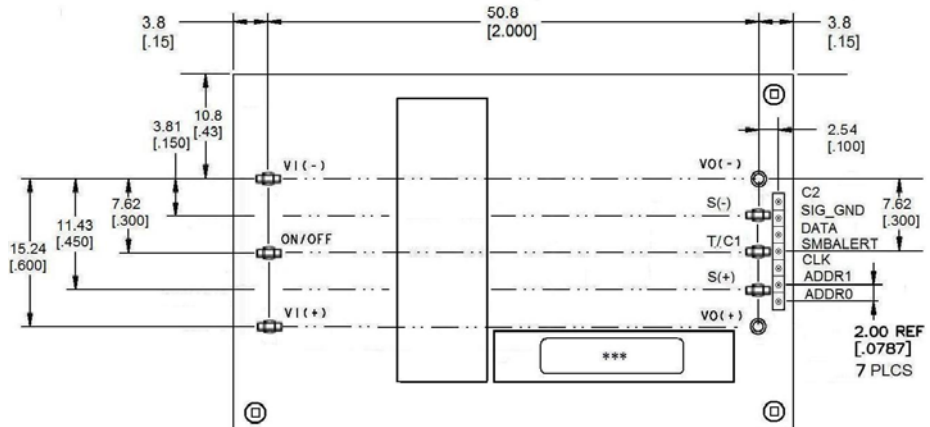

Recommended Pad Layouts

Dimensions are in millimeters and [inches].

Tolerances: x.x mm ± 0.5 mm [x.xx in. ± 0.02 in.] (unless otherwise indicated)

x.xx mm ± 0.25 mm [x.xxx in ± 0.010 in.]

Through-Hole Modules

Pin Number	Pin Name
1	VIN(+)
2	ON/OFF
3	VIN(-)
4	VOUT(-)
5	SENSE(-)
6	TRIM/C1
7	SENSE(+)
8	VOUT(+)
9	C2
10	SIG_GND
11	DATA
12	SMBALERT
13	CLK
14	ADDR1
15	ADDR0

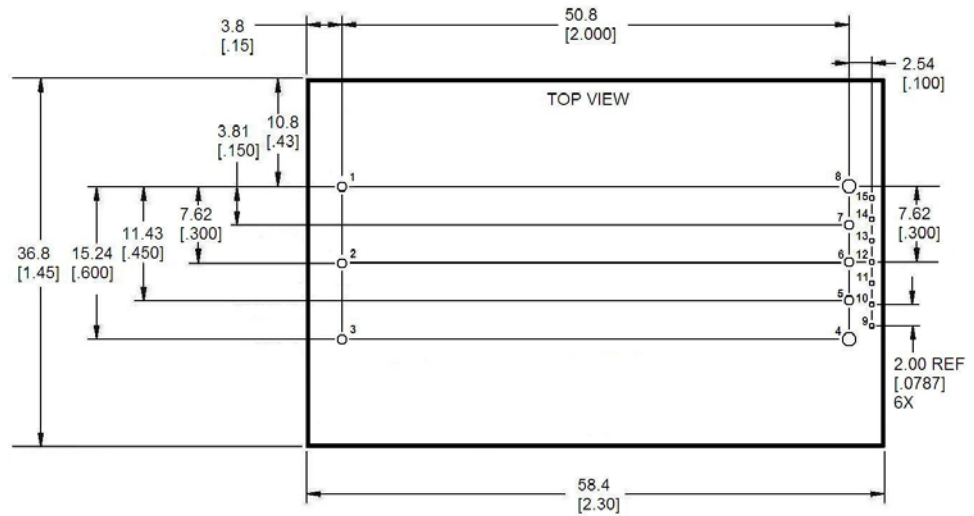

Ordering Information

Please contact your Lineage Power Sales Representative for pricing, availability and optional features.

Table 1. Device Codes

Product codes	Input Voltage	Output Voltage	Output Current	Efficiency	Connector Type	Comcodes
QBDW033A0B41Z	48V (36-75Vdc)	12V	33A	96%	Through hole	TBD
QBDW033A0B41-HZ	48V (36-75Vdc)	12V	33A	96%	Through hole	TBD
QBDW033A0B41-PHZ	48V (36-75Vdc)	12V	33A	96%	Through hole	TBD

Table 2. Device Options

	Characteristic	Character and Position	Definition
Ratings	Form Factor	Q	Q = Quarter Brick
	Family Designator	BD	BD=BARRACUDA Series
	Input Voltage	W	W = Wide Range, 36V-75V
	Output Current	033A0	033A0 = 033.0 Amps Maximum Output Current
	Output Voltage*	B	B =12.0V nominal
Options	Pin Length	8 6 5	Omit = Default Pin Length shown in Mechanical Outline Figures 8 = Pin Length: 2.79 mm ± 0.25mm , (0.110 in. ± 0.010 in.) 6 = Pin Length: 3.68 mm ± 0.25mm , (0.145 in. ± 0.010 in.) 5 = Pin Length: 6.35 mm ± 0.25mm , (0.250 in. ± 0.010 in.)
	Action following Protective Shutdown*	4	Omit = Latching Mode 4 = Auto-restart following shutdown (Overcurrent/Overvoltage)
	On/Off Logic*	1	Omit = Positive Logic 1 = Negative Logic
	Mechanical Features	P H	Omit = Standard open Frame Module P = Active load sharing (Parallel Operation) H = Heat plate, for use with heat sinks or cold-walls
	Customer Specific	XY	XY = Customer Specific Modified Code, Omit for Standard Code
	RoHS	Z	Omit = RoHS 5/6, Lead Based Solder Used Z = RoHS 6/6 Compliant, Lead free

* Feature may be reconfigured from factory default using PMBus. See Feature Descriptions for additional details.



LINEAGE POWER[®]

World Wide Headquarters
Lineage Power Corporation
601 Shiloh Road, Plano, TX 75074, USA
+1-800-526-7819
(Outside U.S.A.: **+1-972-244-9428**)
www.lineagepower.com
e-mail: techsupport1@lineagepower.com

Asia-Pacific Headquarters
Tel: +65 6593 7211

Europe, Middle-East and Africa Headquarters
Tel: +49 89 878067-280

India Headquarters
Tel: +91 80 28411633

Lineage Power reserves the right to make changes to the product(s) or information contained herein without notice. No liability is assumed as a result of their use or application. No rights under any patent accompany the sale of any such product(s) or information.

Lineage Power DC-DC products are protected under various patents. Information on these patents is available at www.lineagepower.com/patents.

© 2009 Lineage Power Corporation, (Plano, Texas) All International Rights Reserved.