

General Description

The MIC5256 is an efficient, precise CMOS voltage regulator. It offers better than 1% initial accuracy, extremely low-dropout voltage (typically 135mV at 150mA) and low ground current (typically 90 μ A) over load. The MIC5256 features an error flag that indicates an output fault condition such as overcurrent, thermal shutdown and dropout.

Designed specifically for handheld and battery-powered devices, the MIC5256 provides a TTL-logic-compatible enable pin. When disabled, power consumption drops nearly to zero.

The MIC5256 also works with low-ESR ceramic capacitors, reducing the amount of board space necessary for power applications, critical in hand-held wireless devices.

Key features include current limit, thermal shutdown, faster transient response, and an active clamp to speed up device turnoff. Available in the IttyBitty[®] SOT-23-5 package and the new Thin SOT-23-5, which offers the same footprint as the standard IttyBitty[®] SOT-23-5, but only 1mm tall. The MIC5256 offers a range of output voltages.

Data sheets and support documentation can be found on Micrel's web site at www.micrel.com.

Features

- Input voltage range: 2.7V to 6.0V
- Thin SOT package: 1mm height
- Error flag indicates fault condition
- Stable with ceramic output capacitor
- Ultralow dropout: 135mV @ 150mA
- High output accuracy:
 - 1.0% initial accuracy
 - 2.0% over temperature
- Low quiescent current:90 μ A
- Tight load and line regulation
- Thermal-shutdown and current-limit protection
- “Zero” off-mode current
- TTL logic-controlled enable input

Applications

- Cellular phones and pagers
- Cellular accessories
- Battery-powered equipment
- Laptop, notebook, and palmtop computers
- Consumer/personal electronics

Typical Application

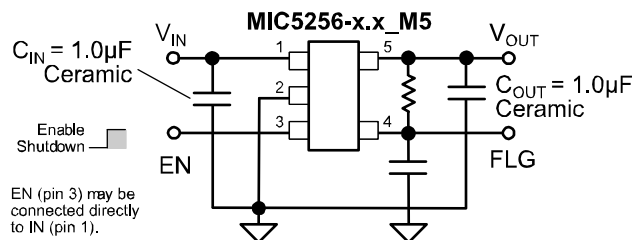

Low-Noise Regulator Application

IttyBitty is a registered trademark of Micrel, Inc.

Ordering Information

Part Number		Marking		Voltage**	Junction Temperature Range	Package
Standard	Pb-Free	Standard	Pb-Free*			
MIC5256-1.5BM5	MIC5256-1.5YM5	LX15	<u>L</u> X15	1.5V	-40° to +125°C	5-Pin SOT23
MIC5256-1.8BM5	MIC5256-1.8YM5	LX18	<u>L</u> X18	1.8V	-40° to +125°C	5-Pin SOT23
MIC5256-2.5BM5	MIC5256-2.5YM5	LX25	<u>L</u> X25	2.5V	-40° to +125°C	5-Pin SOT23
MIC5256-2.6BM5	MIC5256-2.6YM5	LX26	<u>L</u> X26	2.6V	-40° to +125°C	5-Pin SOT23
MIC5256-2.7BM5	MIC5256-2.7YM5	LX27	<u>L</u> X27	2.7V	-40° to +125°C	5-Pin SOT23
MIC5256-2.8BM5	MIC5256-2.8YM5	LX28	<u>L</u> X28	2.8V	-40° to +125°C	5-Pin SOT23
MIC5256-2.85BM5	MIC5256-2.85YM5	LX2J	<u>L</u> X2J	2.85V	-40° to +125°C	5-Pin SOT23
MIC5256-2.9BM5	MIC5256-2.9YM5	LX29	<u>L</u> X29	2.9V	-40° to +125°C	5-Pin SOT23
MIC5256-3.0BM5	MIC5256-3.0YM5	LX30	<u>L</u> X30	3.0V	-40° to +125°C	5-Pin SOT23
MIC5256-3.1BM5	MIC5256-3.1YM5	LX31	<u>L</u> X31	3.1V	-40° to +125°C	5-Pin SOT23
MIC5256-3.3BM5	MIC5256-3.3YM5	LX33	<u>L</u> X33	3.3V	-40° to +125°C	5-Pin SOT23
MIC5256-2.85BD5	MIC5256-2.85YD5	NX2J	<u>N</u> X2J	2.85V	-40° to +125°C	5-Pin TSOT23

Notes:

- * Under bar symbol () may not be to scale.
- ** Other Voltage available. Contact Micrel for details.

Pin Configuration

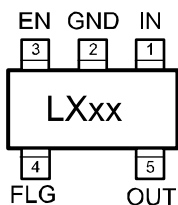

MIC5256-x.xBM5
5-Pin SOT23

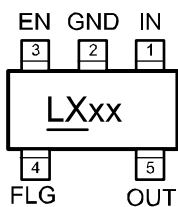

MIC5256-x.xYM5
5-Pin SOT23

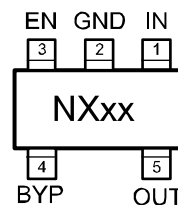

MIC5256-x.xBD5
5-Pin Thin SOT23

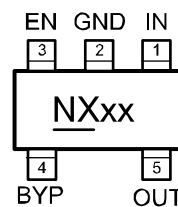

MIC5256-x.xYD5
5-Pin Thin SOT23

Pin Description

Pin Number	Pin Name	Pin Name
1	IN	Supply Input.
2	GND	Ground.
3	EN	Enable/Shutdown (Input): CMOS compatible input. Logic high = enable; logic low = shutdown. Do not leave open.
4	FLG	Error Flag (Output): Open-drain output. Active low indicates an output undervoltage condition.
5	OUT	Regulator Output.

Absolute Maximum Ratings⁽¹⁾

Supply Voltage (V_{IN})	0V to +7V
Enable Voltage (V_{EN})	0V to +7V
Power Dissipation (P_D)	Internally Limited ⁽³⁾
Junction Temperature (T_J)	-40°C to +125°C
Storage Temperature (T_S)	-60°C to +150°C
Lead Temperature (soldering, 5 sec.)	260°C
EDS Rating ⁽⁴⁾	2kV

Operating Ratings⁽²⁾

Supply Voltage (V_{IN})	+2.7V to +6V
Enable Voltage (V_{EN})	0V to V_{IN}
Junction Temperature (T_J)	-40°C to +125°C
Thermal Resistance	
SOT23-5 (θ_{JA})	235°C/W

Electrical Characteristics⁽⁵⁾

$V_{IN} = V_{OUT} + 1V$, $V_{EN} = V_{IN}$; $I_{OUT} = 100\mu A$; $T_J = 25^\circ C$, **bold** values indicate $-40^\circ C \leq T_J \leq +125^\circ C$; unless noted.

Symbol	Parameter	Condition	Min.	Typ.	Max.	Units
V_O	Output Voltage Accuracy	$I_{OUT} = 100\mu A$	-1 -2		1 2	% %
ΔV_{LNR}	Line Regulation	$V_{IN} = V_{OUT} + 1V$ to 6V		0.02	0.05	%/V
ΔV_{LDR}	Load Regulation	$I_{OUT} = 0.1mA$ to 150mA ⁽⁶⁾		1.5	2.5	%
$V_{IN} - V_{OUT}$	Dropout Voltage ⁽⁷⁾	$I_{OUT} = 100\mu A$		0.1	5	mV
		$I_{OUT} = 100mA$		90	150	mV
		$I_{OUT} = 150mA$		135	200 250	mV mV
I_Q	Quiescent Current	$V_{EN} \leq 0.4V$ (shutdown)		0.2	1	μA
I_{GND}	Ground Pin Current ⁽⁸⁾	$I_{OUT} = 0mA$		90	150	μA
		$I_{OUT} = 150mA$		117		μA
PSRR	Ripple Rejection	$f = 10Hz$, $V_{IN} = V_{OUT} + 1V$; $C_{OUT} = 1.0\mu F$		60		dB
		$f = 100Hz$, $V_{IN} = V_{OUT} + 0.5V$; $C_{OUT} = 1.0\mu F$		60		dB
		$f = 10kHz$, $V_{IN} = V_{OUT} + 0.5V$		45		dB
I_{LIM}	Current Limit	$V_{OUT} = 0V$	160	425		mV
e_n	Output Voltage Noise			TBD		$\mu V(rms)$
Enable Input						
V_{IL}	Enable Input Logic-Low Voltage	$V_{IN} = 2.7V$ to 5.5V, regulator shutdown			0.4	V
V_{IH}	Enable Input Logic-High Voltage	$V_{IN} = 2.7V$ to 5.5V, regulator enabled	1.6			V
I_{EN}	Enable Input Current	$V_{IL} \leq 0.4V$, regulator shutdown		0.01		μA
		$V_{IH} \geq 1.6V$, regulator enabled		0.01		μA
	Shutdown Resistance Discharge			500		Ω

Electrical Characteristics⁽⁵⁾ (Continued)

$V_{IN} = V_{OUT} + 1V$, $V_{EN} = V_{IN}$; $I_{OUT} = 100\mu A$; $T_J = 25^\circ C$, **bold** values indicate $-40^\circ C \leq T_J \leq +125^\circ C$; unless noted.

Symbol	Parameter	Condition	Min.	Typ.	Max.	Units
Error Flag						
V_{FLG}	Low Threshold	% of V_{OUT} (Flag ON)	90			%
	High Threshold	% of V_{OUT} (Flag OFF)			96	%
V_{OL}	Output Logic-Low Voltage	$I_L = 100\mu A$, fault condition		0.02	0.1	V
I_{FL}	Flag Leakage Current	flag off, $V_{FLG} = 6V$		0.01		μA
Thermal Protection						
	Thermal-Shutdown Temperature			150		$^\circ C$
	Thermal-Shutdown Hysteresis			10		$^\circ C$

Notes:

- Exceeding the absolute maximum rating may damage the device.
- The device is not guaranteed to function outside its operating rating.
- The maximum allowable power dissipation of any T_A (ambient temperature) is $P_{D(max)} = T_{J(max)} - T_A / \theta_{JA}$. Exceeding the maximum allowable power dissipation will result in excessive die temperature, and the regulator will go into thermal shutdown. The θ_{JA} of the MIC5255-x.xBM5 (all versions) is $235^\circ C/W$ on a PC board (see "Thermal Considerations" section for further details).
- Devices are ESD sensitive. Handling precautions recommended.
- Specification for packaged product only.
- Regulation is measured at constant junction temperature using low duty cycle pulse testing. Parts are tested for load regulation in the load range from 0.1mA to 150mA. Changes in output voltage due to heating effects are covered by the thermal regulation specification.
- Dropout Voltage is defined as the input to output differential at which the output voltage drops 2% below its nominal value measured at 1V differential. For outputs below 2.7V, dropout voltage is the input-to-output voltage differential with the minimum input voltage 2.7V. Minimum input operating voltage is 2.7V.
- Ground pin current is the regulator quiescent current. The total current drawn from the supply is the sum of the load current plus the ground pin current.

Test Circuit

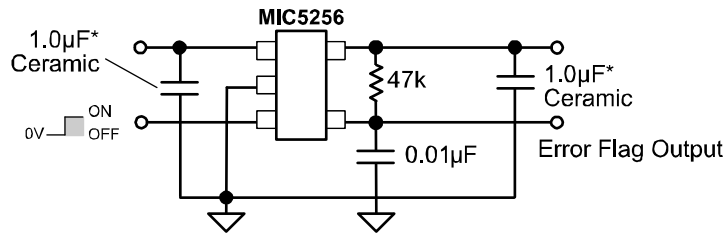

* $C_{IN} = C_{OUT} = 1\mu F$

Typical Characteristics

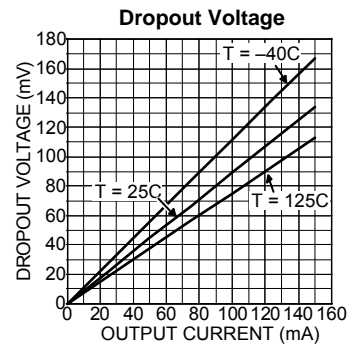
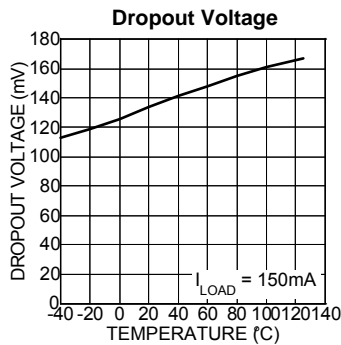
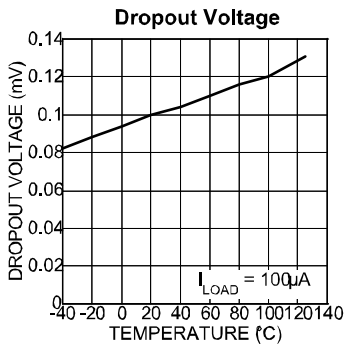
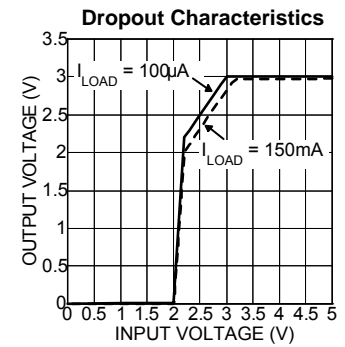
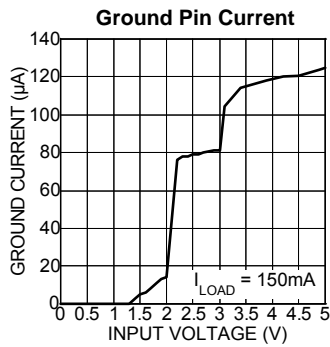
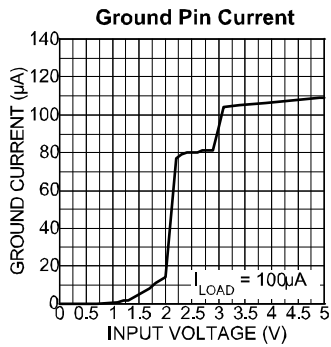
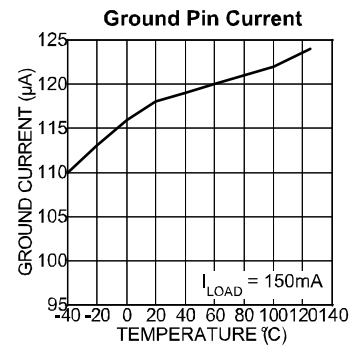
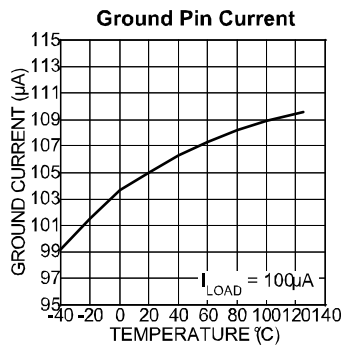
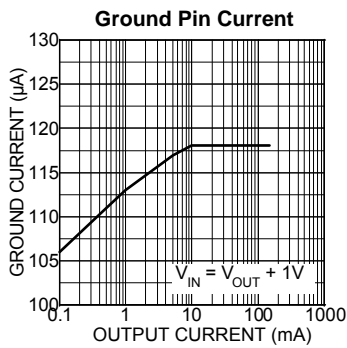
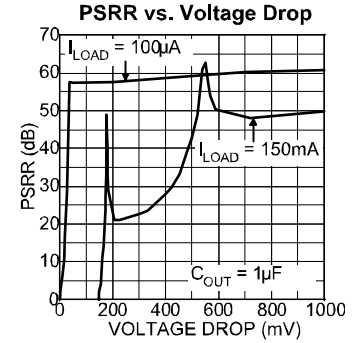
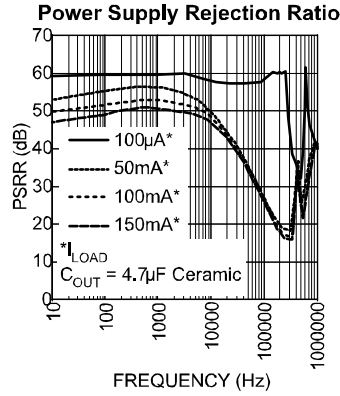
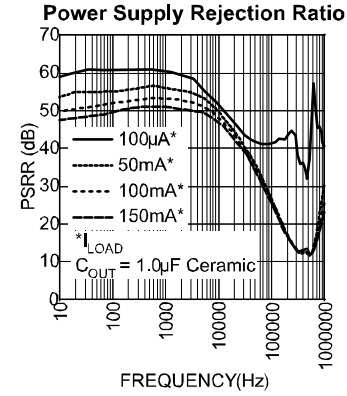

Typical Characteristics (Continued)

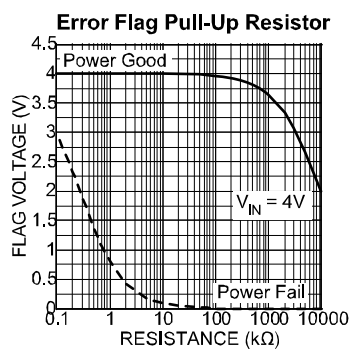
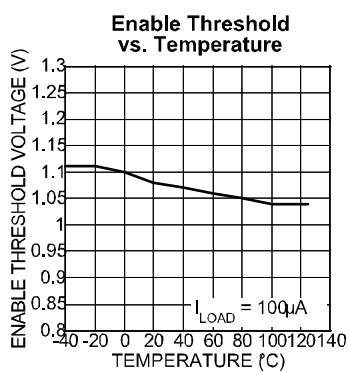
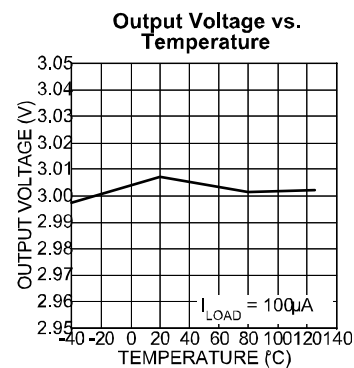
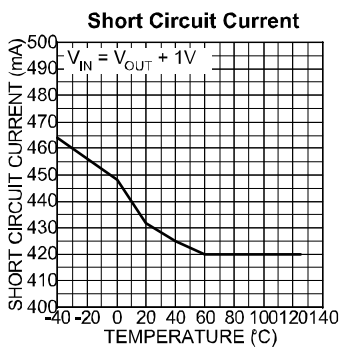
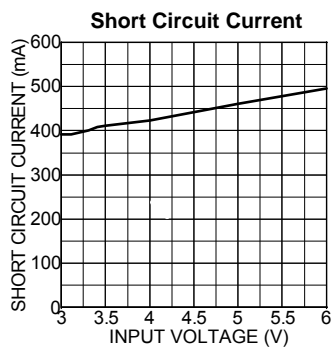

Functional Characteristics

Load Transient Response

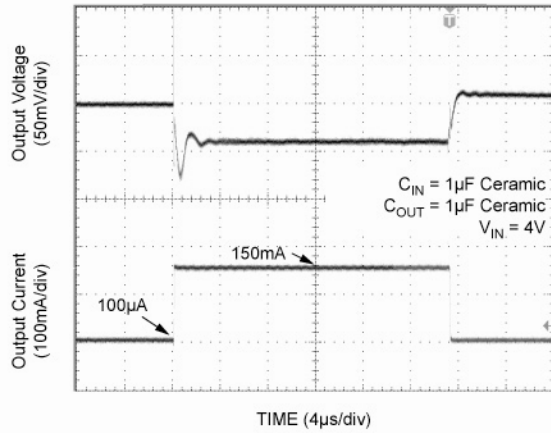

Line Transient Response

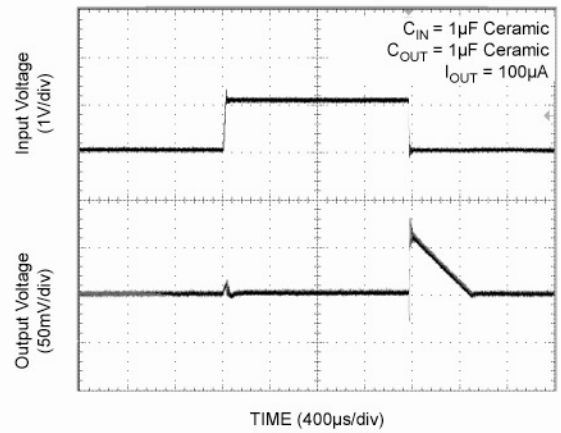

Enable Pin Delay

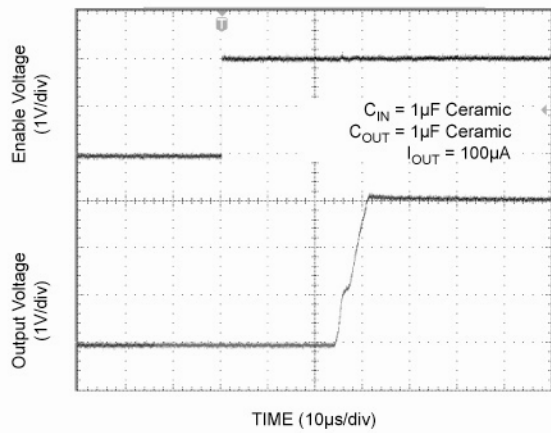

Shutdown Delay

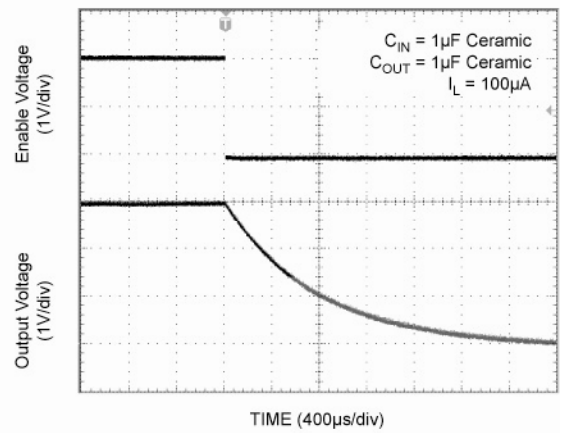

Error Flag Start-up*

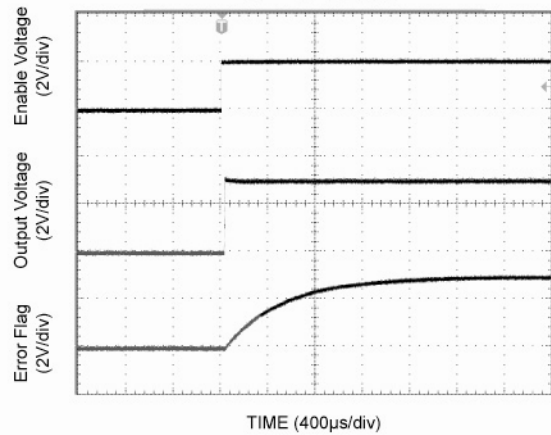

Error Flag Shutdown*

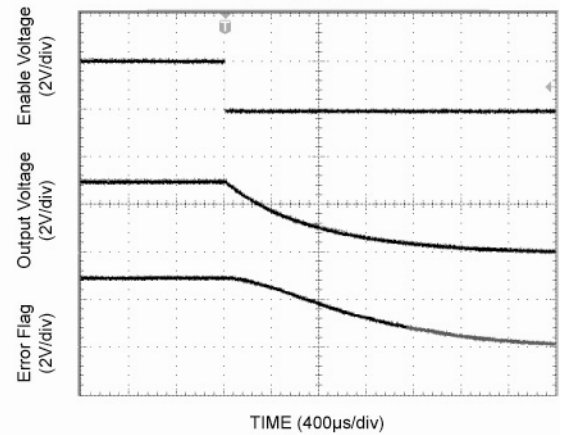

* See Test Circuit

* See Test Circuit

Functional Diagram

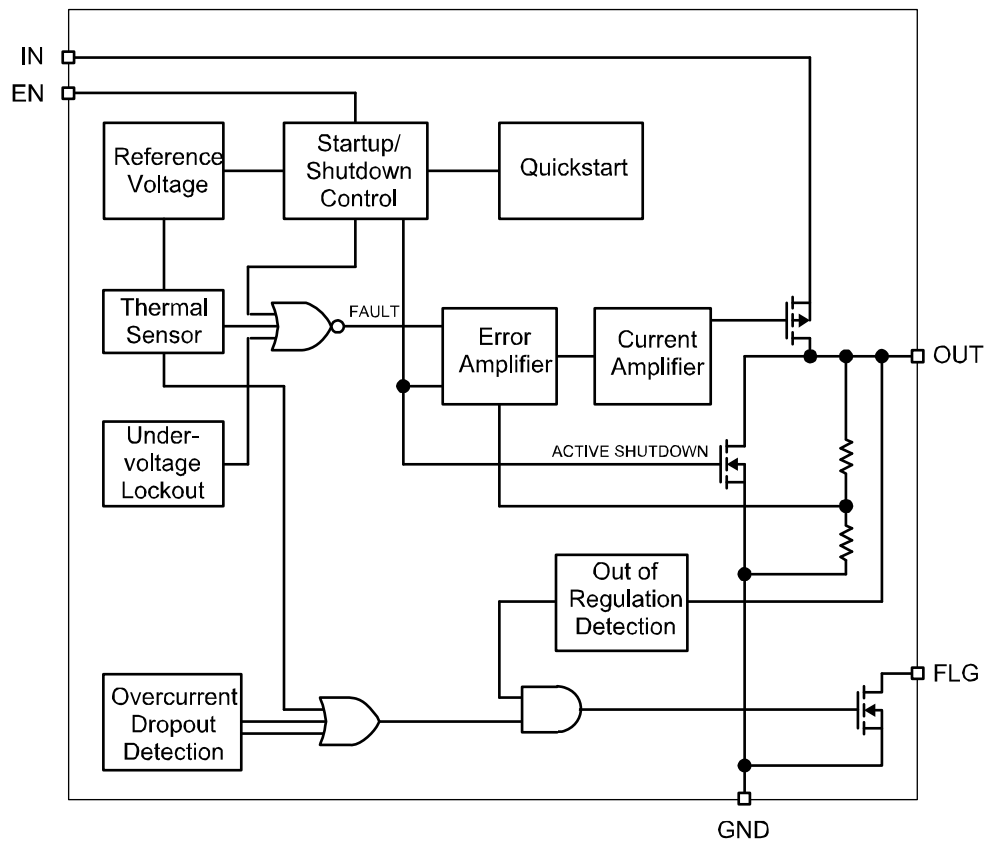

Application Information

Enable/Shutdown

The MIC5256 comes with an active-high enable pin that allows the regulator to be disabled. Forcing the enable pin low disables the regulator and sends it into a “zero” off-mode-current state. In this state, current consumed by the regulator goes nearly to zero. Forcing the enable pin high enables the output voltage. This part is CMOS and the enable pin cannot be left floating; a floating enable pin may cause an indeterminate state on the output.

Input Capacitor

The MIC5256 is a high-performance, high-bandwidth device. Therefore, it requires a well-bypassed input supply for optimal performance. A 1 μ F capacitor is required from the input to ground to provide stability. Low-ESR ceramic capacitors provide optimal performance at a minimum of space. Additional high-frequency capacitors, such as small valued NPO dielectric type capacitors, help filter out high frequency noise and are good practice in any RF based circuit.

Output capacitor

The MIC5256 requires an output capacitor for stability. The design requires 1 μ F or greater on the output to maintain stability. The design is optimized for use with low-ESR ceramic-chip capacitors. High-ESR capacitors may cause high-frequency oscillation. The maximum recommended ESR is 300m Ω . The output capacitor can be increased, but performance has been optimized for a 1 μ F ceramic output capacitor and does not improve significantly with larger capacitance.

X7R/X5R dielectric-type ceramic capacitors are recommended because of their temperature performance. X7R-type capacitors change capacitance by 15% over their operating temperature range and are the most stable type of ceramic capacitors. Z5U and Y5V dielectric capacitors change value by as much as 50% and 60% respectively over their operating temperature ranges. To use a ceramic chip capacitor with Y5V dielectric, the value must be much higher than an X7R ceramic capacitor to ensure the same minimum capacitance over the equivalent operating temperature range.

Error Flag

The error flag output is an active-low, open-drain output that drives low when a fault condition AND an under-voltage detection occurs. Internal circuitry intelligently monitors overcurrent, overtemperature and dropout conditions and ORs these outputs together to indicate some fault condition. The output of that OR gate is ANDed with an output voltage monitor that detects an undervoltage condition. That output drives the open-

drain transistor to indicate a fault. This prevents chattering or inadvertent triggering of the error flag. The error flag must be pulled-up using a resistor from the flag pin to either the input or the output.

The error flag circuit was designed essentially to work with a capacitor to ground to act as a power-on reset generator, signaling a power-good situation once the regulated voltage was up and/or out of a fault condition. This capacitor delays the error signal from pulling high, allowing the down stream circuits time to stabilize. When the error flag is pulled-up to the input without using a pull-down capacitor, then there can be a glitch on the error flag upon start up of the device. This is due to the response time of the error flag circuit as the device starts up. When the device comes out of the “zero” off mode current state, all the various nodes of the circuit power up before the device begins supplying full current to the output capacitor. The error flag drives low immediately and then releases after a few microseconds. The intelligent circuit that triggers an error detects the output going into current limit AND the output being low while charging the output capacitor. The error output then pulls low for the duration of the turn-on time. A capacitor from the error flag to ground will filter out this glitch. The glitch does not occur if the error flag pulled up to the output.

Active Shutdown

The MIC5256 also features an active shutdown clamp, which is an N-channel MOSFET that turns on when the device is disabled. This allows the output capacitor and load to discharge, de-energizing the load.

No Load Stability

The MIC5256 will remain stable and in regulation with no load unlike many other voltage regulators. This is especially important in CMOS RAM keep-alive applications.

Thermal Considerations

The MIC5256 is designed to provide 150mA of continuous current in a very small package. Maximum power dissipation can be calculated based on the output current and the voltage drop across the part. To determine the maximum power dissipation of the package, use the junction-to-ambient thermal resistance of the device and the following basic equation:

$$P_{D(max)} = \left(\frac{T_{J(max)} - T_A}{\theta_{JA}} \right)$$

$T_{J(max)}$ is the maximum junction temperature of the die, $125^{\circ}C$, and T_A is the ambient operating temperature. θ_{JA} is layout dependent; Table 1 shows examples of junction-to-ambient thermal resistance for the MIC5256.

Package	θ_{JA} Recommended Minimum Footprint	θ_{JA} 1" Square Copper Clad	θ_{JC}
SOT23-5 (M5 or D5)	235°C/W	185°C/W	145°C/W

Table 1. SOT-23-5 Thermal Resistance

The actual power dissipation of the regulator circuit can be determined using the equation:

$$P_D = (V_{IN} - V_{OUT}) I_{OUT} + V_{IN} I_{GND}$$

Substituting $P_{D(max)}$ for P_D and solving for the operating conditions that are critical to the application will give the maximum operating conditions for the regulator circuit. For example, when operating the MIC5256-3.0BM5 at $50^{\circ}C$ with a minimum footprint layout, the maximum input voltage for a set output current can be determined as follows:

$$P_{D(max)} = \left(\frac{125^{\circ}C - 50^{\circ}C}{235^{\circ}C/W} \right)$$

$$P_{D(max)} = 315mW$$

The junction-to-ambient thermal resistance for the minimum footprint is $235^{\circ}C/W$, from Table 1. The maximum power dissipation must not be exceeded for proper operation. Using the output voltage of 3.0V and an output current of 150mA, the maximum input voltage

can be determined. Because this device is CMOS and the ground current is typically $100\mu A$ over the load range, the power dissipation contributed by the ground current is $< 1\%$ and can be ignored for this calculation.

$$315mW = (V_{IN} - 3.0V) 150mA$$

$$315mW = V_{IN} \cdot 150mA - 450mW$$

$$810mW = V_{IN} \cdot 150mA$$

$$V_{IN(max)} = 5.4V$$

Therefore, a 3.0V application at 150mA of output current can accept a maximum input voltage of 5.4V in a SOT-23-5 package. For a full discussion of heat sinking and thermal effects on voltage regulators, refer to the "Regulator Thermals" section of Micrel's *Designing with Low-Dropout Voltage Regulators* handbook.

Fixed Regulator Applications

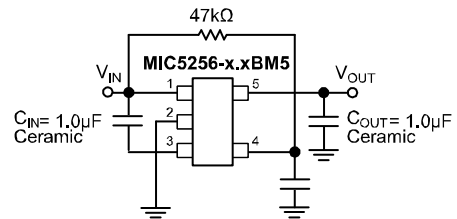
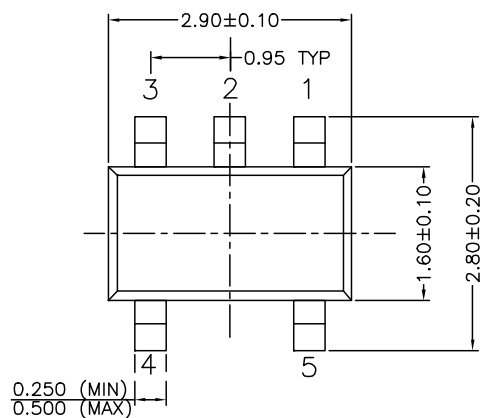

Figure 1. Low-Noise Fixed Voltage Application

Figure 1 shows a standard low-noise configuration with a $47k\Omega$ pull-up resistor from the error flag to the input voltage and a pull-down capacitor to ground for the purpose of fault indication. EN (Pin 3) is connected to IN (Pin 1) for an application where enable/shutdown is not required. $C_{OUT} = 1.0\mu F$ minimum.

Package Information



TOP VIEW

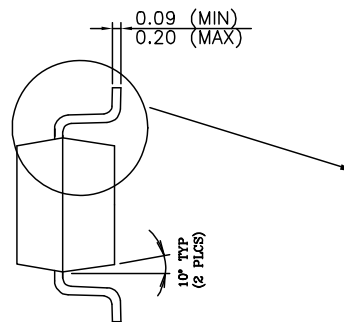

END VIEW

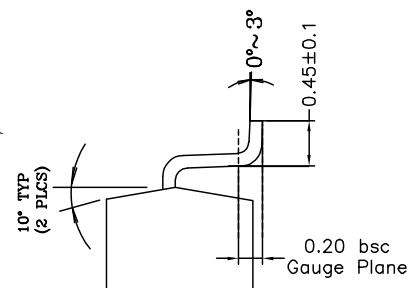

DETAIL

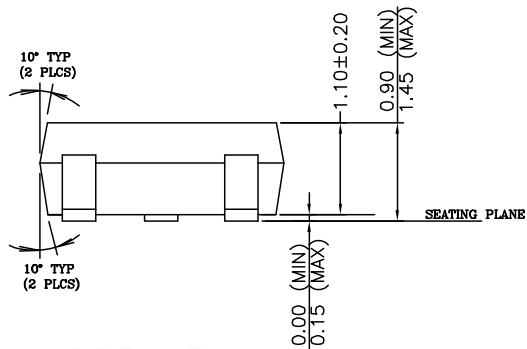

SIDE VIEW 1

NOTE:

1. PACKAGE OUTLINE EXCLUSIVE OF MOLD FLASH & BURR.
2. PACKAGE OUTLINE INCLUSIVE OF SOLER PLATING.
3. DIMENSION AND TOLERANCE PER ANSI Y14.5M, 1982.
4. FOOT LENGTH MEASUREMENT BASED ON GAUGE PLANE METHOD.
5. DIE FACES UP FOR MOLD, AND FACES DOWN FOR TRIM/FORM.
6. ALL DIMENSIONS ARE IN MILLIMETERS.

5-Pin SOT (M5)

Package Information (Continued)

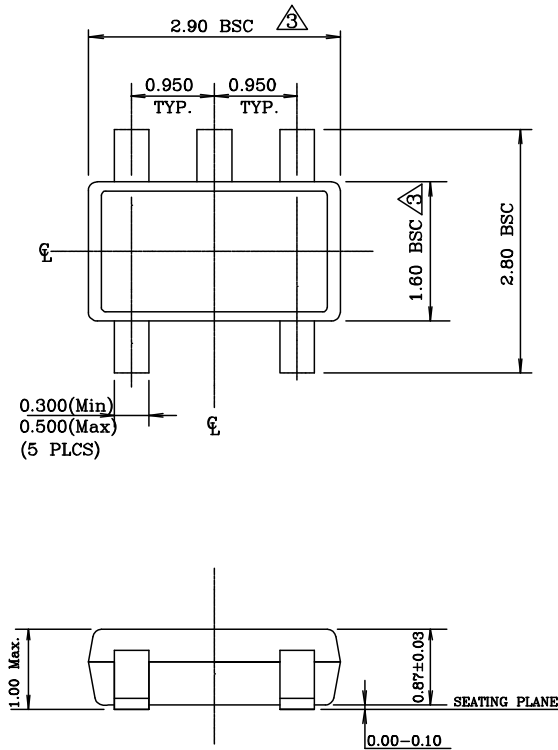

NOTE:

1. Dimensions and tolerances are as per ANSI Y14.5M, 1994.
2. Die is facing up for mold. Die is facing down for trim/form, ie. reverse trim/form.
3. Dimensions are exclusive of mold flash and gate burr.
4. The footlength measuring is based on the gauge plane method.
5. All specification comply to Jedec Spec M0193 Issue C.
6. All dimensions are in millimeters.

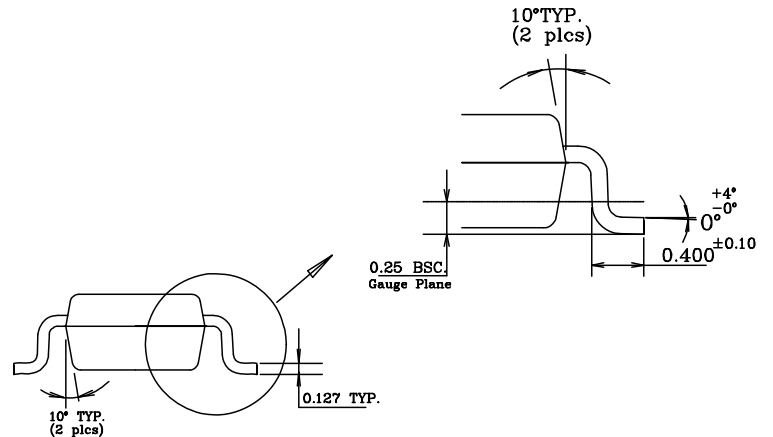

5-Pin Thin SOT (D5)

MICREL, INC. 2180 FORTUNE DRIVE SAN JOSE, CA 95131 USA

TEL +1 (408) 944-0800 FAX +1 (408) 474-1000 WEB <http://www.micrel.com>

The information furnished by Micrel in this data sheet is believed to be accurate and reliable. However, no responsibility is assumed by Micrel for its use. Micrel reserves the right to change circuitry and specifications at any time without notification to the customer.

Micrel Products are not designed or authorized for use as components in life support appliances, devices or systems where malfunction of a product can reasonably be expected to result in personal injury. Life support devices or systems are devices or systems that (a) are intended for surgical implant into the body or (b) support or sustain life, and whose failure to perform can be reasonably expected to result in a significant injury to the user. A Purchaser's use or sale of Micrel Products for use in life support appliances, devices or systems is a Purchaser's own risk and Purchaser agrees to fully indemnify Micrel for any damages resulting from such use or sale.

© 2003 Micrel, Incorporated.