

RoHS Compliant Product

## Description

The SSC2138 positive, linear regulators feature low quiescent current (45µA typ.) with low dropout voltage, making them ideal for battery applications. Output voltage are set at the factory and trimmed to 1.5% accuracy. These rugged devices have both Thermal Shutdown and Current Fold-back to prevent device failure under the "Worst" of operating conditions. The SSC2138 is stable with an output capacitance of 4.7µF or greater.

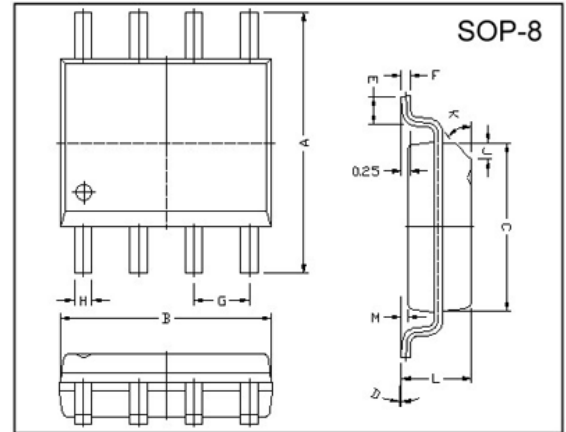

## Features

- \* Low Temperature Coefficient
- \* Over-Temperature Shutdown
- \* Adjustable Version
- \* Very Low Dropout Voltage
- \* High Accurate ±1.5%
- \* Short Circuit Current Fold-back
- \* Guaranteed 1.5A output
- \* Current Limiting
- \* Power-Saving Shutdown Mode

REF.	Millimeter		REF.	Millimeter	
	Min.	Max.		Min.	Max.
A	5.80	6.20	M	0.10	0.25
B	4.80	5.00	H	0.35	0.49
C	3.80	4.00	L	1.35	1.75
D	0	8	J	0.375 REF.	
E	0.40	0.90	K	45°	
F	0.19	0.25	G	1.27 TYP.	

## Applications

- \* PC Peripherals
- \* Wireless Devices
- \* Portable Electronics
- \* Battery Powered Widgets
- \* Instrumentation

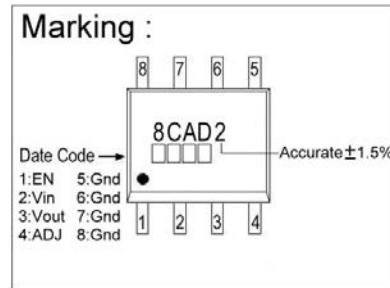

## Typical Application Circuit

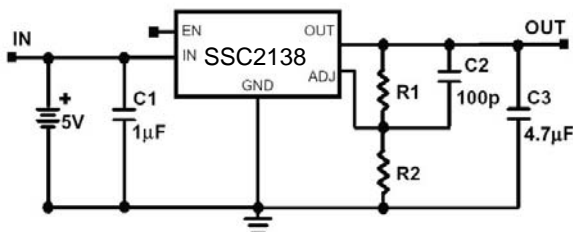

## Functional Block Diagram

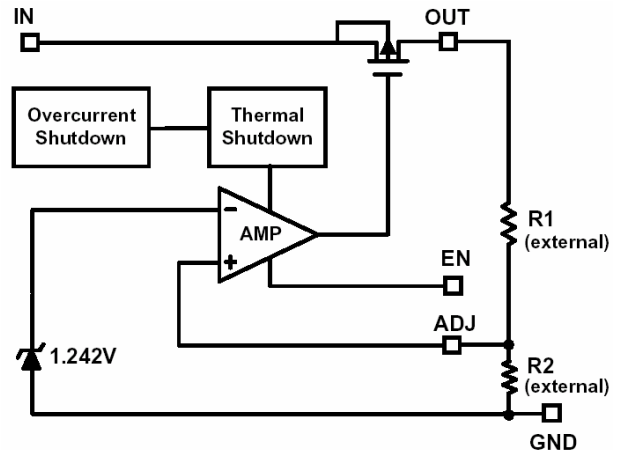



Elektronische Bauelemente

# SSC2138

1.5A CMOS

Low Dropout Voltage Regulator

## Absolute Maximum Ratings

Parameter	Symbol	Ratings	Unit
Input Voltage	$V_{IN}$	8	V
Output Current	$I_{OUT}$	$P_D/(V_{IN}-V_O)$	mA
Output Voltage	$V_{OUT}$	Gnd-0.3 to $V_{IN}+0.3$	V
Operating Ambient Temperature	$T_{opr}$	-40~+85	°C
Junction Temperature	$T_j$	-40~+125	°C
Max. Junction Temperature	$T_j \text{ Max.}$	150	°C
Power Dissipation ( $\Delta T=100^\circ\text{C}$ )	$P_D$	810	mW
EDS Classification		B	

## Electrical Characteristics $T_a=25^\circ\text{C}$ unless otherwise noted ( $V_{IN}=V_{OUT}(T)+2V, V_{EN}=V_{IN}$ )

Parameter	Symbol	Min.	Typ.	Max.	Unit	Condition
Output Voltage	$V_{OUT}(E)^1$	-1.5%	$V_{OUT}(T)^2$	1.5%	V	$V_{EN}=V_{ENmin}, I_o=1\text{mA}$
Output Current	$I_o$	1.5	-	-	A	$V_o>1.2V$
Current Limit	$I_{LIM}$	1.5	2.0	-	A	$V_o>1.2V$
Load Regulation	$REG_{LOAD}$	-1	0.2	1	%	$I_o=1\text{mA}\sim 1.5A$
Dropout Voltage	$V_{DROPOUT}$	-	-	1300	mV	$1.5V < V_{OUT}(T) \leq 2.0V$
		-	-	800		$2.0V < V_{OUT}(T) \leq 2.8V$
		-	-	600		$2.8V < V_{OUT}(T)$
						$I_o=1.5A$ $V_o=V_{OUT}(E)-2\%$
Ground Pin Current	$I_{GND}$	-	45	-	uA	$I_o=1\text{mA}\sim 1.5A$
Line Regulation	$REG_{LINE}$	-0.15	-	0.15	%	$V_{OUT}(T) < 2.0V$
		-0.1	0.02	0.1		$2.0V \leq V_{OUT}(T) < 4.0V$
		-0.4	-	0.4		$4.0V \leq V_{OUT}(T)$
						$I_o=1\text{mA}$ $V_{IN}=V_{OUT}(T)+1$ to $V_{OUT}(T)+2$
Input Voltage	$V_{IN}$	Note <sup>3</sup>	-	7	V	
Over Temperature Shutdown	$O_{TS}$	-	150	-	°C	
Over Temperature Hysteresis	$O_{TH}$	-	30	-	°C	
Output Voltage Temperature Coefficient	$T_C$	-	30	-	ppm/°C	
Short Circuit Current	$I_{SC}$	-	750	-	mA	$V_{OUT} < 0.4V$
Power Supply Rejection	PSRR	-	50	-	dB	$f=1\text{kHz}$
		-	20	-		$f=10\text{kHz}$
						$I_o=100\text{mA}$ $C_o=4.7\mu\text{F}$ (ceramic)
Output Voltage Noise	eN	-	30	-	uVrms	$f=10\text{Hz}\sim 100\text{kHz}, I_o=10\text{mA}$ $C_o=4.7\mu\text{F}$
EN Input Threshold	$V_{EH}$	2	-	$V_{IN}$	V	$V_{IN}=2.7V$ to $7V$
	$V_{EL}$	0	-	0.4		
EN Input Bias Current	$I_{EH}$	-	-	0.1	uA	$V_{IN}=7V$
	$I_{EL}$	-	-	0.5		$V_{EN}=0V, V_{IN}=7V$
Shutdown Supply Current	$I_{SD}$	-	0.5	2	uA	$V_{IN}=5V, V_{OUT}=0V, V_{EN}=0V$
ADJ Input Bias Current	$I_{ADJ}$	-	1	-	uA	$V_{IN}=5V, V_{ADJ}=1.242V$
Min. Load Current	$I_{MIN}$	1	-	-	mA	
ADJ Reference Voltage	$V_{REF}$	1.223	1.242	1.261	V	

Note 1:  $V_{OUT}(E)$  =Effective Output Voltage (i.e. the output voltage when " $V_{OUT}(T)+2.0V$ " is provided at the  $V_{IN}$  pin while maintaining a certain  $I_{OUT}$  value).

2:  $V_{OUT}(T)$  =Specified Output Voltage

3:  $V_{IN}(MIN)$  = $V_{OUT}+V_{DROPOUT}$

## Ordering Information(contd.)

Part Number	Marking	Output Voltage	Part Number	Marking	Output Voltage
SSC2138-AD	8CAD2 XXXX	Adjustable			

## Detailed Description

The SSC2138 of COMS regulators contain a PMOS pass transistor, voltage reference, error amplifier, over-current protection and thermal shutdown. The P-channel pass transistor receives data from the error amplifier, over-current shutdown, and thermal protection circuits. During normal operation, the error amplifier compares the output voltage to a precision reference. Over-current and Thermal shutdown circuits become active when the junction temperature exceeds 140°C, or the current exceeds 2.2A. During thermal shutdown, the output voltage remains low. Normal operation is restored when the junction temperature drops below 120°C. The SSC2138 behaves like a current source when the load reaches 2.2A. However, if the load impedance drops below 0.3 Ω, the current drops back to 600mA to prevent excessive power dissipation. Normal operation is restored when the load resistance exceeds of 0.75 Ω.

## External Capacitors

The SSC2138 is stable with an output capacitance to ground of 4.7uF or greater. Ceramic capacitors have the lowest ESR, and will offer the best AC performance. Conversely, Aluminum Electrolytic capacitors exhibit the highest ESR, resulting in the poorest AC response. Unfortunately, large value ceramic capacitors are comparatively expensive. One option is to parallel a 0.1uF ceramic capacitor with a 10uF Aluminum Electrolytic. The benefit is low ESR, high capacitance, and low overall cost. A second capacitor is recommended between the input and ground to stabilize V<sub>IN</sub>. The input capacitor should be at least 0.1uF to have a beneficial effect. All capacitors should be placed in closed proximity to the pins. A "Quiet" ground termination is desirable. This can be achieved with a "Star" connection.

## Enable

When EN pin is pulled low, the PMOS pass transistor shuts off, and all internal circuits are powered down. In this state, the quiescent current is less than 2uA. This pin behaves much like an electronic switch. 100KΩ resistor is necessary between V<sub>EN</sub> source and EN pin when V<sub>EN</sub> is higher than V<sub>IN</sub>. (Note: There is no internal pull-up for EN pin.)

## Adjustable Version

The adjustable version uses external feedback resistors to generate an output voltage anywhere from 1.5V to 5.0V. V<sub>adj</sub> is trimmed to 1.242V and V<sub>out</sub> is given by the equation:

$$V_{OUT} = V_{adj} * (1 + R1/R2)$$

Feedback resistors R1 and R2 should be high enough to keep quiescent current low, but increasing R1+R2 will reduce stability. In general, R1 and R2 in the 10's of kΩ will produce adequate stability, given reasonable layout precautions. To improve stability characteristics, keep parasitic on the ADJ pin to min., and lower R1 and R2 values.

**Characteristics Curve**

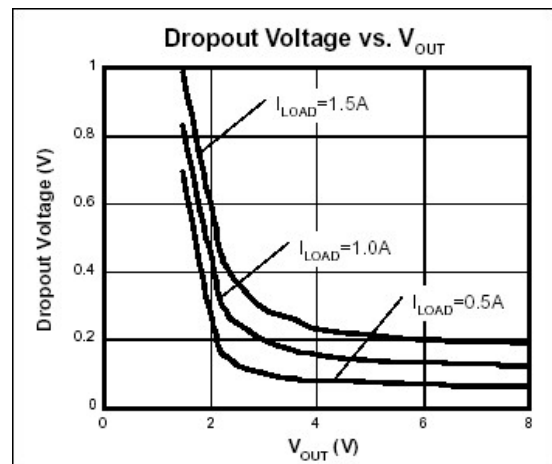
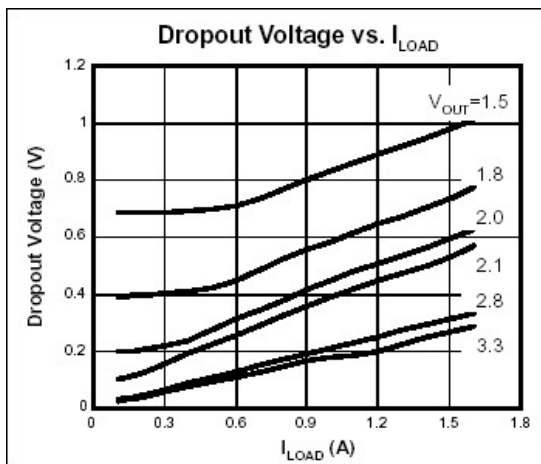
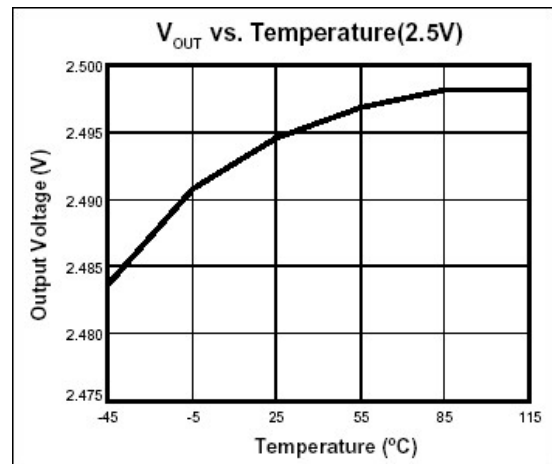
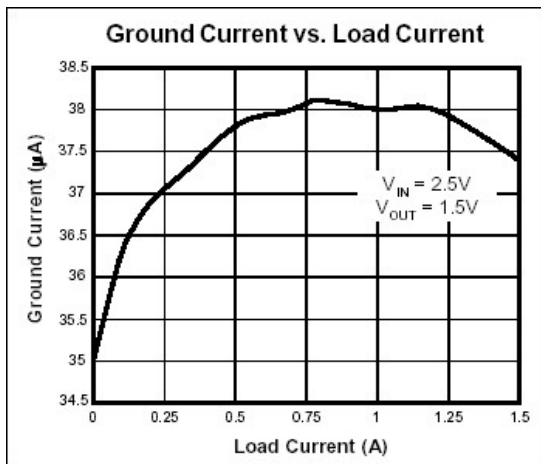
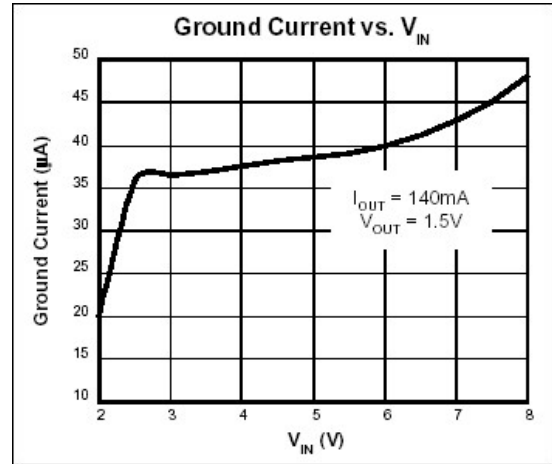
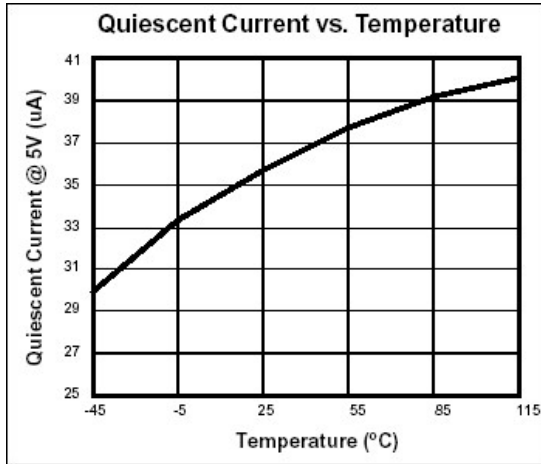

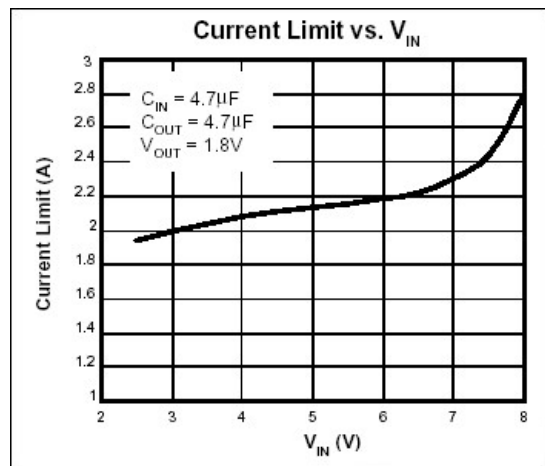
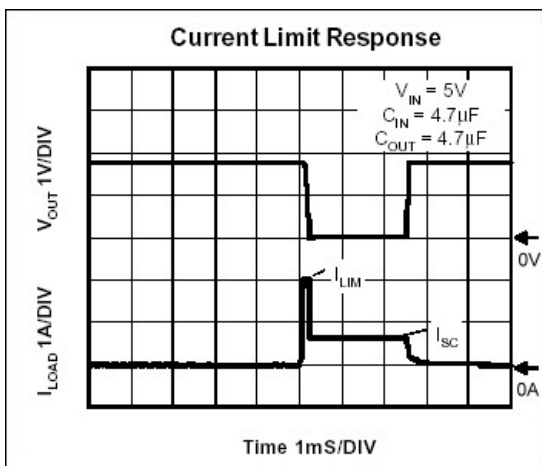
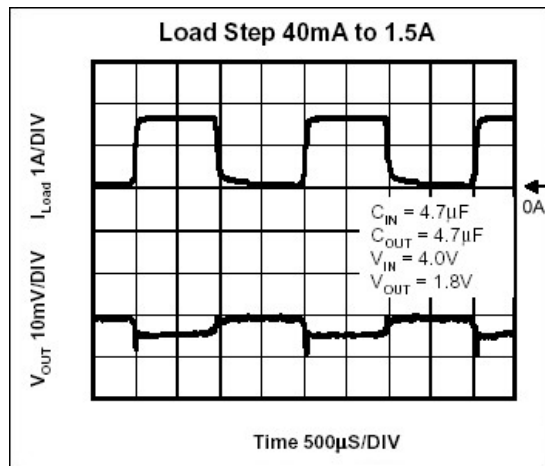
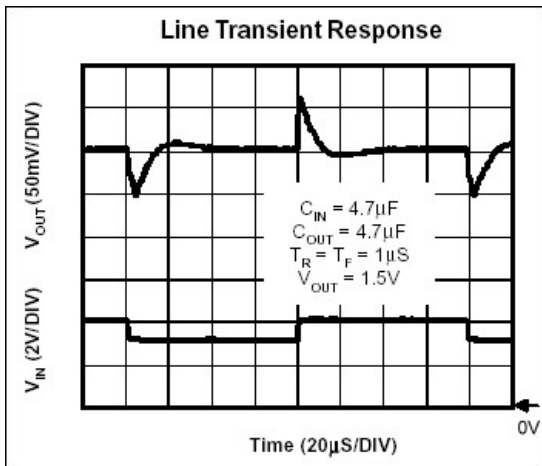
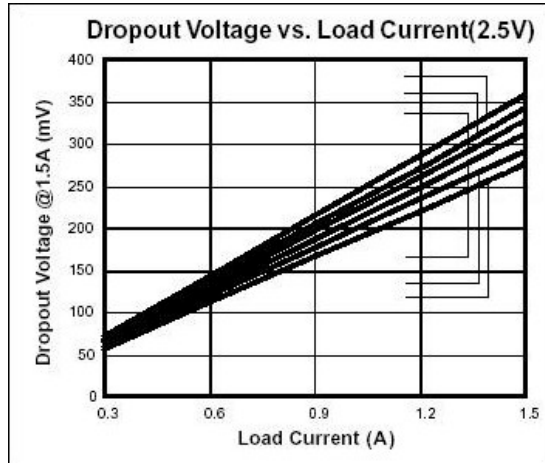
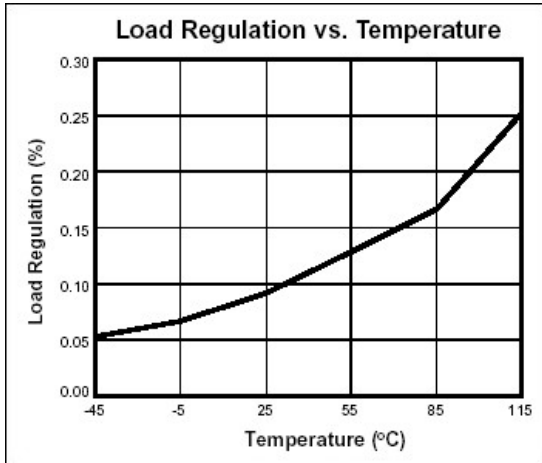

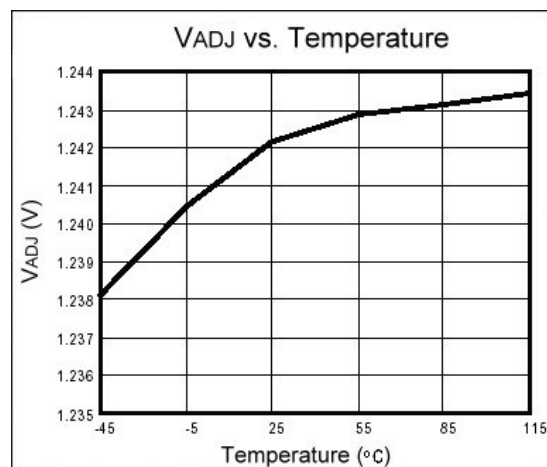
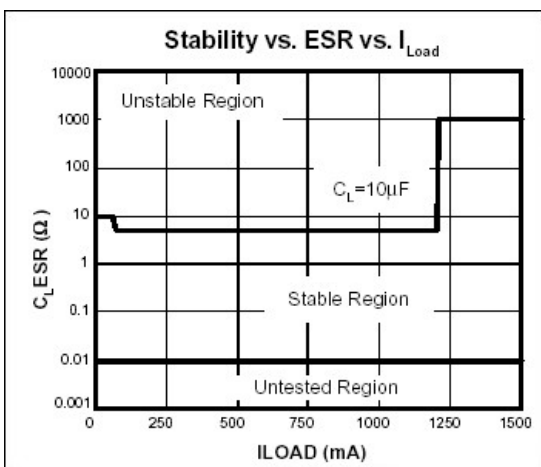
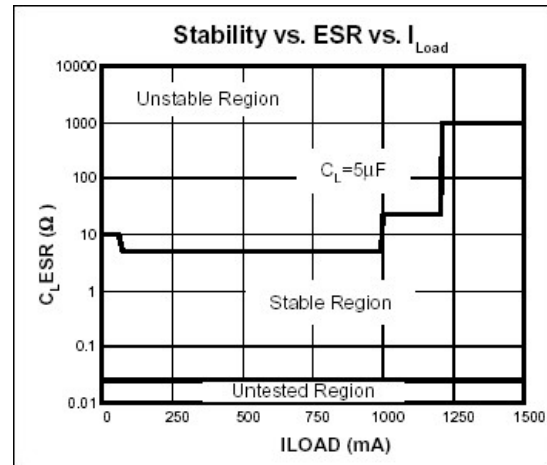
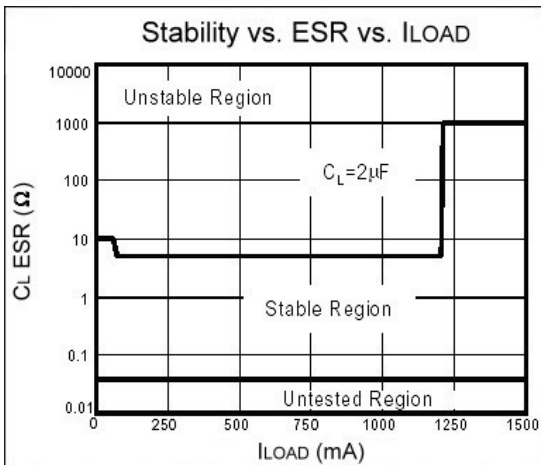
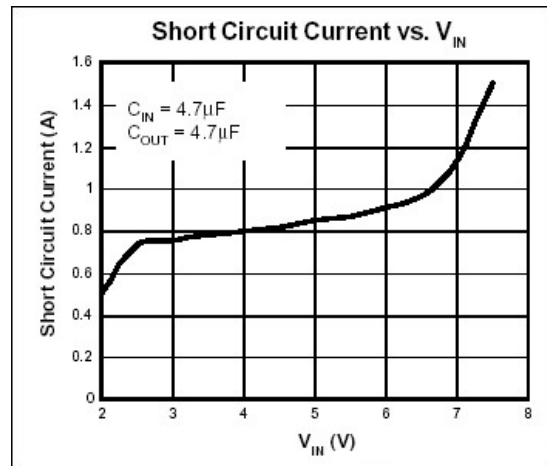
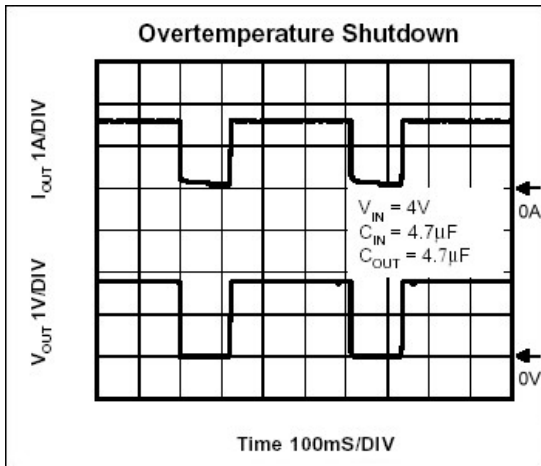



Elektronische Bauelemente

# SSC2138

1.5A CMOS  
Low Dropout Voltage Regulator

## External Resistor Divider Table

R1(kΩ)	1	2	5	10	20	50
VOUT	$R2(k\Omega)=(1.242*R1(k\Omega))/(V_{OUT}-1.242)$					
1.30	21.41	42.83	107.07	214.14	428.28	1070.7
1.35	11.50	23.00	57.50	115.00	230.00	575.00
1.40	7.86	15.72	39.30	78.61	157.22	393.04
1.45	5.97	11.94	29.86	59.71	119.42	298.56
1.50	4.81	9.63	24.07	48.14	96.28	240.70
1.55	4.03	8.06	20.16	40.32	80.65	201.62
1.60	3.47	6.94	17.35	34.69	68.39	173.46
1.65	3.04	6.09	15.22	30.44	60.88	152.21
1.70	2.71	5.42	13.56	27.12	54.24	135.59
1.75	2.44	4.89	12.22	24.45	48.90	122.24
1.80	2.23	4.45	11.13	22.26	44.52	111.29
1.85	2.04	4.09	10.21	20.43	40.86	102.14
1.90	1.89	3.78	9.44	18.88	37.75	94.38
1.95	1.75	3.51	8.77	17.54	35.08	87.71
2.00	1.64	3.28	8.19	16.39	32.77	81.93
2.05	1.54	3.07	7.69	15.37	30.74	76.86
2.10	1.45	2.90	7.24	14.48	28.95	72.38
2.15	1.37	2.74	6.84	13.68	27.36	68.39
2.20	1.30	2.59	6.48	12.96	25.93	64.82
2.25	1.23	2.46	6.16	12.32	24.65	61.61
2.30	1.17	2.35	5.87	11.74	23.48	58.70
2.35	1.12	2.24	5.60	11.21	22.42	56.05
2.40	1.07	2.15	5.36	10.73	21.45	53.63
2.45	1.03	2.06	5.14	10.28	20.56	51.41
2.50	0.99	1.97	4.94	9.87	19.75	49.36
2.55	0.95	1.90	4.75	9.50	18.99	47.48
2.60	0.91	1.83	4.57	9.15	18.29	45.73
2.65	0.88	1.76	4.41	8.82	17.64	44.11
2.70	0.85	1.70	4.26	8.52	17.04	42.59
2.75	0.82	1.65	4.12	8.24	16.47	41.18
2.80	0.80	1.59	3.99	7.97	15.94	39.86
2.85	0.77	1.54	3.86	7.72	15.45	38.62
2.90	0.75	1.50	3.75	7.49	14.98	37.45
2.95	0.73	1.45	3.64	7.27	14.54	36.36
3.00	0.71	1.41	3.53	7.06	14.13	35.32
3.05	0.69	1.37	3.43	6.87	13.74	34.35
3.10	0.67	1.34	3.34	6.68	13.37	33.42
3.15	0.65	1.30	3.25	6.51	13.02	32.55

R1(kΩ)	1	2	5	10	20	50
VOUT	$R2(k\Omega)=(1.242*R1(k\Omega))/(V_{OUT}-1.242)$					
3.20	0.63	1.27	3.17	6.34	12.69	31.72
3.25	0.62	1.24	3.09	6.19	12.37	30.93
3.30	0.60	1.21	3.02	6.03	12.07	30.17
3.35	0.59	1.18	2.95	5.89	11.78	29.46
3.40	0.58	1.15	2.88	5.76	11.51	28.78
3.45	0.56	1.13	2.81	5.63	11.25	28.13
3.50	0.55	1.10	2.75	5.50	11.00	27.50
3.55	0.54	1.08	2.69	5.38	10.76	26.91
3.60	0.53	1.05	2.63	5.27	10.53	26.34
3.65	0.52	1.03	2.58	5.16	10.32	25.79
3.70	0.51	1.01	2.53	5.05	10.11	25.26
3.75	0.50	0.99	2.48	4.95	9.90	24.76
3.80	0.49	0.97	2.43	4.86	9.71	24.28
3.85	0.48	0.95	2.38	4.76	9.52	23.81
3.90	0.47	0.93	2.34	4.67	9.35	23.36
3.95	0.46	0.92	2.29	4.59	9.17	22.93
4.00	0.45	0.90	2.25	4.50	9.01	22.52
4.05	0.44	0.88	2.21	4.42	8.85	22.12
4.10	0.43	0.87	2.17	4.35	8.69	21.73
4.15	0.43	0.85	2.14	4.27	8.54	21.35
4.20	0.42	0.84	2.10	4.20	8.40	20.99
4.25	0.41	0.83	2.06	4.13	8.26	20.64
4.30	0.41	0.81	2.03	4.06	8.12	20.31
4.35	0.40	0.80	2.00	4.00	7.99	19.98
4.40	0.39	0.79	1.97	3.93	7.87	19.66
4.45	0.39	0.77	1.94	3.87	7.74	19.36
4.50	0.38	0.76	1.91	3.81	7.62	19.06
4.55	0.38	0.75	1.88	3.75	7.51	18.77
4.60	0.37	0.74	1.85	3.70	7.40	18.49
4.65	0.36	0.73	1.82	3.64	7.29	18.22
4.70	0.36	0.72	1.80	3.59	7.18	17.96
4.75	0.35	0.71	1.77	3.54	7.08	17.70
4.80	0.35	0.70	1.75	3.49	6.98	17.45
4.85	0.34	0.69	1.72	3.44	6.88	17.21
4.90	0.34	0.68	1.70	3.40	6.79	16.98
4.95	0.33	0.67	1.67	3.35	6.70	16.75
5.00	0.33	0.66	1.65	3.30	6.61	16.52

Note: Small load (greater than 2mA) is necessary as R1 or R2 is larger than 50kΩ. Otherwise, output voltage probably can not be pulled down to 0V on disable mode.