

E-pHEMT MMIC

AE384 (Preliminary)

RFHIC

Product Features

- 50 ~ 6000MHz
- GaAs E-pHEMT MMIC
- Higher linearity
- Low Noise Figure
- High Max input power
- SOT-89 SMD Type package
- Higher productivity
- Lower manufacturing cost
- Pb Free / RoHS Standard

Application

- Cellular, GSM
- PCS, W-CDMA
- Wibro, WiMax



Package : SOT-89

Description

AE384 is a drive or pre-drive amplifier designed in a low cost SOT-89 package.

This MMIC is based on Gallium Arsenide Enhancement Mode pHEMT which shows low current and high IP3.

It is designed as driver devices for infrastructure equipment in the 50~6000MHz Wireless technologies such as Cellular, GSM, PCS, W-CDMA, Wibro, WiMax System.

The data in this spec sheet is valid only for 50 ohm application.

Specifications

PARAMETER	UNIT	MIN	TYP	MAX	Remark
Frequency Range	MHz	50 ~ 6000			
Gain	dB		14		
Input Return Loss	dB		-20		
Output Return Loss	dB		-14		
Output IP3	dBm	36	39		
1dB Compression Point	dBm	21	24		
W-CDMA Power (4FA)	dBm		14		
Noise Figure	dB		1.4	1.9	
DC Current	mA		100		
Supply Voltage	V		5		

NOTE

1. Test conditions unless otherwise noted. Freq=1900~2200MHz, Vdd=+5V, Ta=25°C, 50Ω system
2. OIP3 measured with 2 tones at an output power of +10dBm/tones separated by 1MHz
3. Test Model 1, 64DPC, 3.84MHz BW, @±5MHz and ±10MHz offset

Absolute Minimum and Maximum Ratings

PARAMETER	UNIT	MIN	TYP	MAX
Device Voltage	V		+5	+6
Operating Temperature	°C	-40		+85
Storage Temperature	°C	-40		+150

E-pHEMT MMIC **AE384** (Preliminary)



⊙ Application Circuit: 1900MHz ~ 2200MHz, 50ohm System

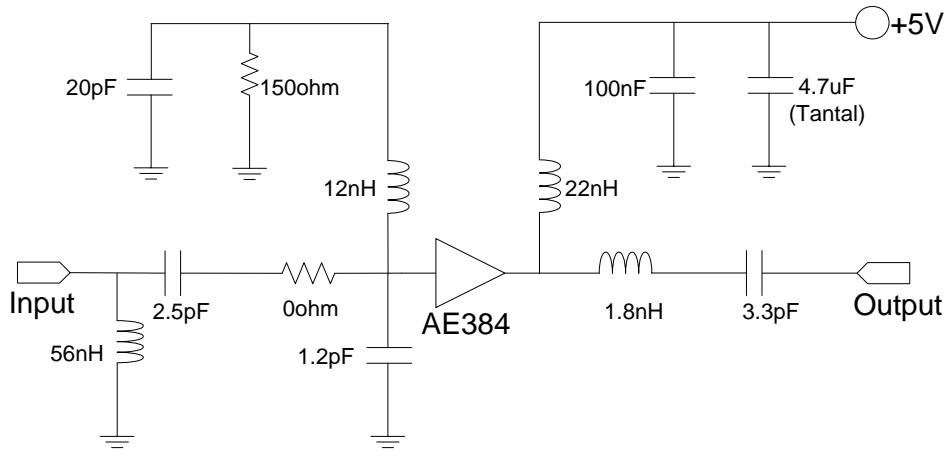

⊙ Typical RF Performance: VDD=5V, IDS=100mA, TA=25°C, 50ohm System

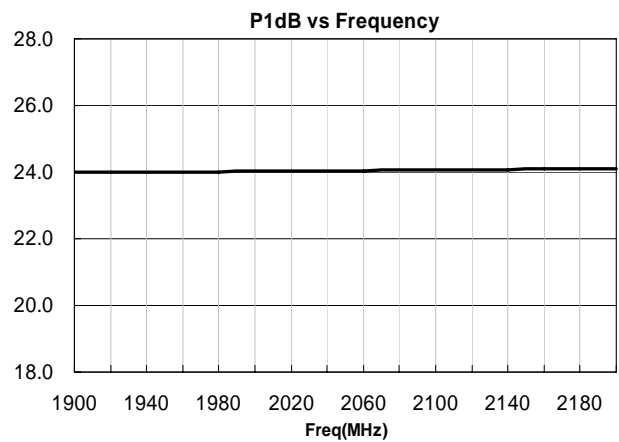
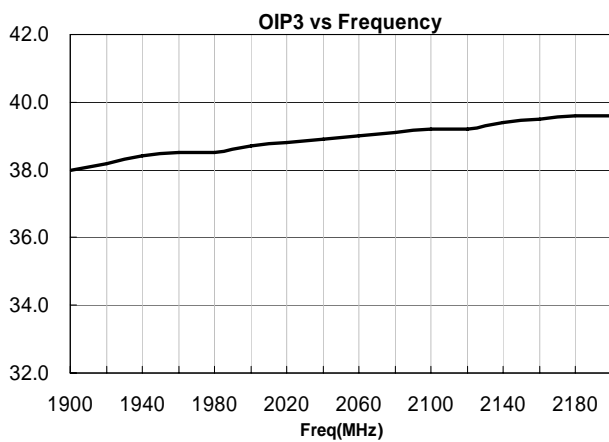
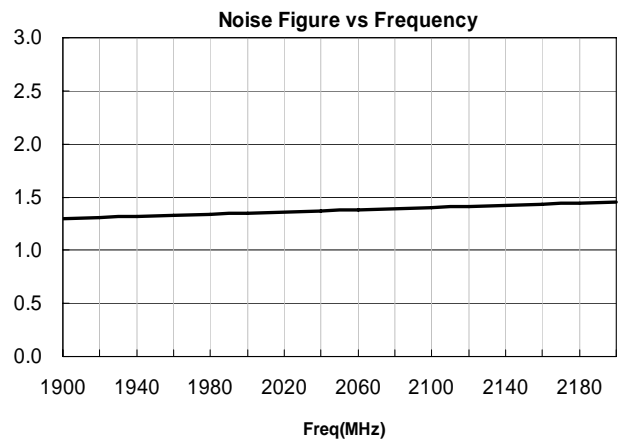
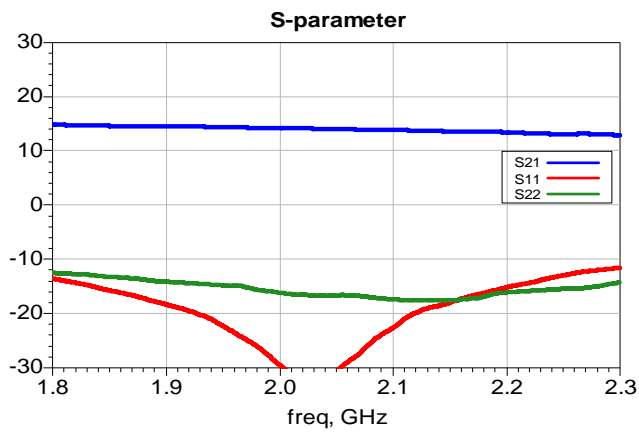

E-pHEMT MMIC AE384 (Preliminary)



© Application Circuit: 2400MHz ~ 2600MHz, 50ohm System

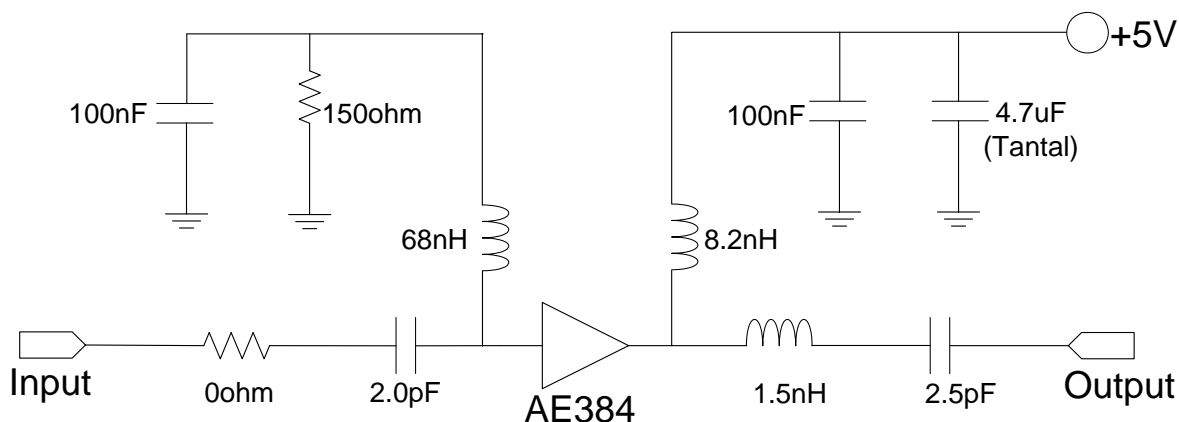

© Typical RF Performance: VDD=5V, IDS=100mA, TA=25°C, 50ohm System

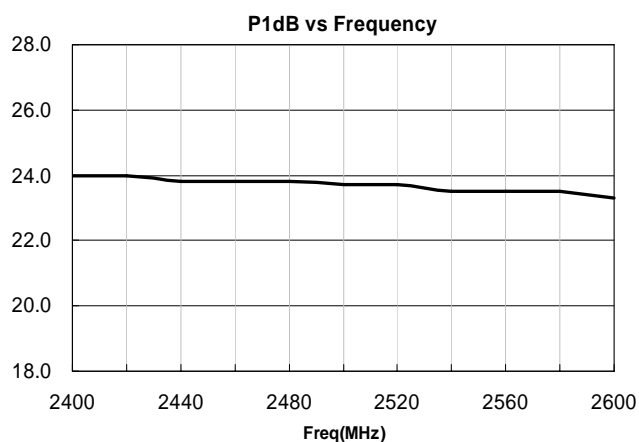
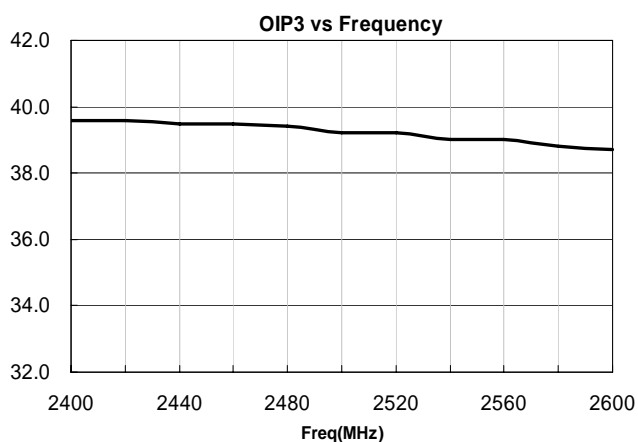
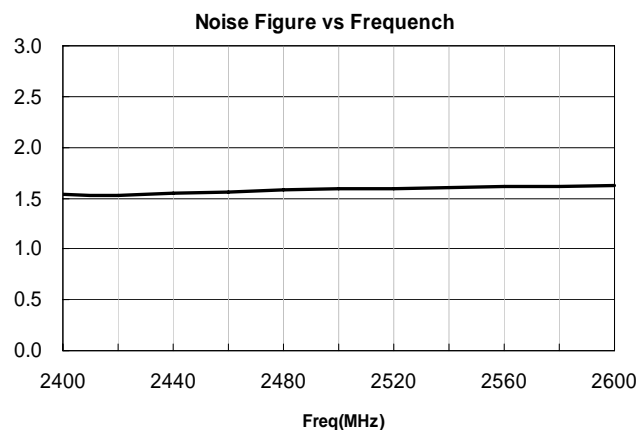
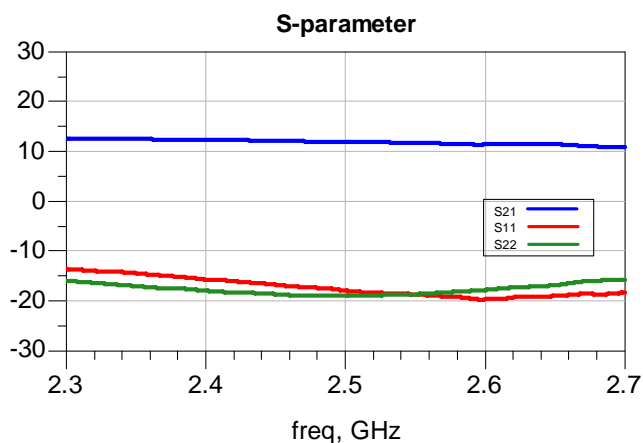

ESD Protection

For a safe use in all situations, it is recommended to have proper ESD control techniques while the device is being handled. Here are some recommended precautions;

- Person at a workbench should be earthed via a wrist strap and a resistor.
- All mains-powered equipment should be connected to the mains via an earth-leakage switch.
- Equipment cases should be grounded.
- Relative humidity should be maintained between 40% and 50%.
- An ionizer is recommended.
- Keep static materials, such as plastic envelopes and plastic trays etc. away from the workbench

Dimensions

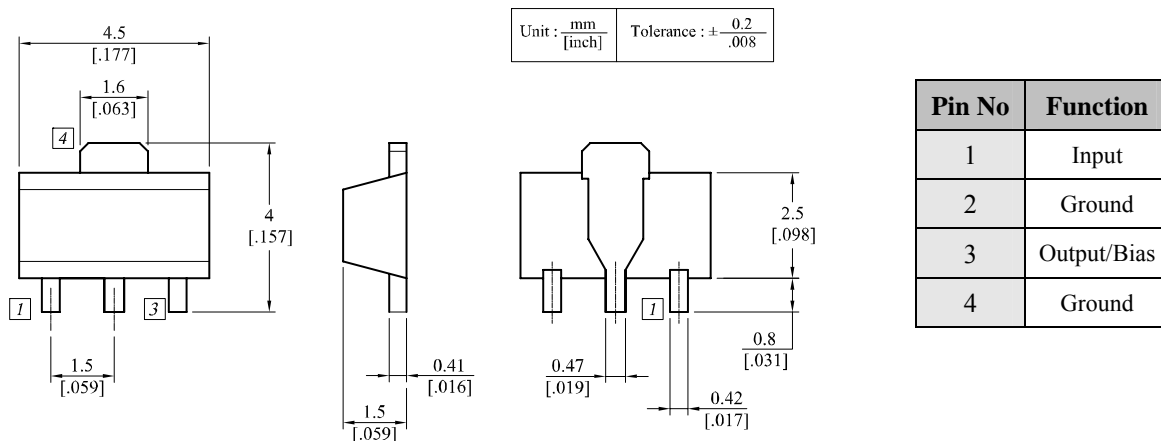

PCB Pad Layout

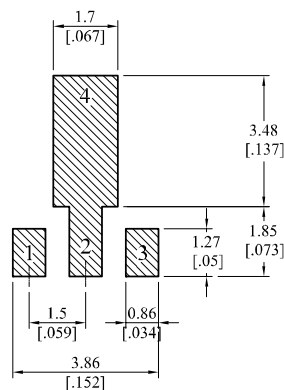

Recommended Mounting Configuration

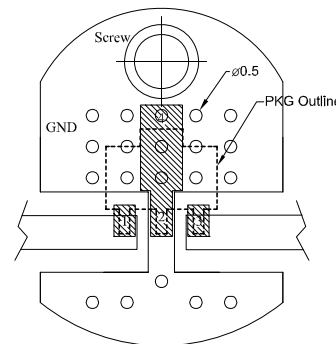

Mounting Configuration Notes

1. Ground / thermal via holes are critical for the proper performance of this device.
2. Add as much copper as possible to inner and outer layers near the part to ensure optimal thermal performance.
3. Mounting screws can be added near the part to fasten the board to a heatsink. Ensure that the ground / thermal via hole region contacts the heatsink.
4. Do not put solder mask on the backside of the PCB in the region where the board contacts the heatsink.
5. RF trace width depends upon the PCB material and construction.
6. Use 1 oz. Copper minimum.
7. All dimensions are in millimeters.

RFHIC Corporation (RFHIC) reserves the right to make changes to any products herein or to discontinue any product at any time without notice. RFHIC do not assume any liability for the suitability of its products for any particular purpose, and disclaims any and all liability, including without limitation consequential or incidental damages. The product specifications herein expressed have been carefully checked and are assumed to be reliable. However, RFHIC disclaims liability for inaccuracies and strongly recommends buyers to verify that the information they are using is current before placing purchase orders. RFHIC products are not intended for use in life support equipment or application where malfunction of the product can be expected to result in personal injury or death. Buyer uses or sells such products for any such unintended or unauthorized application, buyer shall indemnify, protect and hold RFHIC and its directors, officers, stockholders, employees, representatives and distributors harmless against any and all claims arising out of such use. RFHIC's liability under or arising out of damages, claims of whatsoever kind and nature which RFHIC products could cause shall be limited in amount to the net purchase price of the products sold to buyer by RFHIC.