

Parameter	Ratings	Units
Blocking Voltage	60	V _P
Load Current	150	mA
Max R _{ON}	16	Ω
LED Current to Operate	1	mA

Features

- Low Drive Power Requirements (TTL/CMOS Compatible)
- Arc-Free With No Snubbing Circuits
- 3750V_{rms} Input/Output Isolation
- FCC Compatible
- VDE Compatible
- No EMI/RFI Generation
- Machine Insertable, Wave Solderable
- Surface Mount Tape & Reel Version Available

Applications

- Security
 - Passive Infrared Detectors (PIR)
 - Data Signaling
 - Sensor Circuitry
- Instrumentation
 - Multiplexers
 - Data Acquisition
 - Electronic Switching
 - I/O Subsystems
 - Meters (Watt-Hour, Water, Gas)
 - Medical Equipment-Patient/Equipment Isolation
- Security
- Aerospace
- Industrial Controls

Description

Clare's XAA117 is a dual 1-Form-A Solid State Relay that has two independently controlled, optically coupled MOSFET switches.

The MOSFET switches and photovoltaic die use Clare's patented OptoMOS® architecture to provide 3750 V_{rms} of input-to-output isolation. The optically coupled output is controlled by a highly efficient GaAIAs infrared LED.

This dual single-pole OptoMOS relay provides a more compact design solution than discrete single-pole relays in a variety of applications, and saves board space by incorporating both switches in a single 8-Pin package.

Approvals

- UL Recognized: File Number E76270
- CSA Certified: File Number LR 43639-10

Ordering Information

Part #	Description
XAA117	8-Pin DIP (50/Tube)
XAA117S	8-Pin Surface Mount (50/Tube)
XAA117STR	8-Pin Surface Mount (1,000/Reel)
XAA117P	8-Pin Flat Pack (50/Tube)
XAA117PTR	8-Pin Flat Pack (1,000/Reel)

Pin Configuration

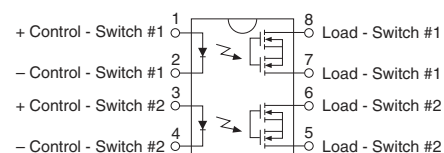

Switching Characteristics of Normally Open (Form A) Devices

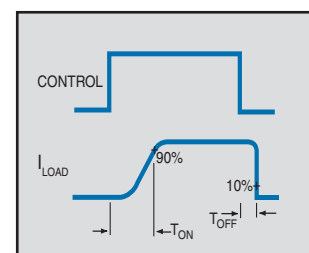

Absolute Maximum Ratings

Parameter	Ratings	Units
Blocking Voltage	60	V_P
Reverse Input Voltage	5	V
Input Control Current	50	mA
Peak (10ms)	1	A
Input Power Dissipation ¹	150	mW
Total Power Dissipation ²	800	mW
Isolation Voltage, Input to Output	3750	V_{rms}
Operational Temperature	-40 to +85	°C
Storage Temperature	-40 to +125	°C

¹ Derate Linearly 1.33 mW/°C

² Derate Linearly 6.67 mW/°C

Electrical absolute maximum ratings are at 25°C

Absolute Maximum Ratings are stress ratings. Stresses in excess of these ratings can cause permanent damage to the device. Functional operation of the device at conditions beyond those indicated in the operational sections of this data sheet is not implied.

Electrical Characteristics

Parameter	Conditions	Symbol	Min	Typ	Max	Units
Output Characteristics @ 25°C						
Load Current						
Continuous ¹	-	I_L	-	-	150	mA
Peak	t = 10ms	I_{LPK}	-	-	400	
On-Resistance	$I_L = 150\text{mA}$	R_{ON}	-	7	16	Ω
Off-State Leakage Current	$V_L = 60\text{V}$	I_{LEAK}	-	-	1	μA
Switching Speeds						
Turn-On	$I_F = 5\text{mA}, V_L = 10\text{V}$	T_{ON}	-	0.1	5	ms
Turn-Off		T_{OFF}	-	0.5	5	
Output Capacitance	50V; f = 1MHz	C_{OUT}	-	25	-	pF
Input Characteristics @ 25°C						
Input Control Current	$I_L = 150\text{mA}$	I_F	-	-	1	mA
Input Dropout Current	-	-	0.05	-	-	mA
Input Voltage Drop	$I_F = 5\text{mA}$	V_F	0.9	1.2	1.4	V
Reverse Input Current	$V_R = 5\text{V}$	I_R	-	-	10	μA
Common Characteristics @ 25°C						
Input to Output Capacitance	-	C_{IO}	-	3	-	pF

¹ If both poles operate, the load current must be derated so as not to exceed the package power dissipation value.

PERFORMANCE DATA*

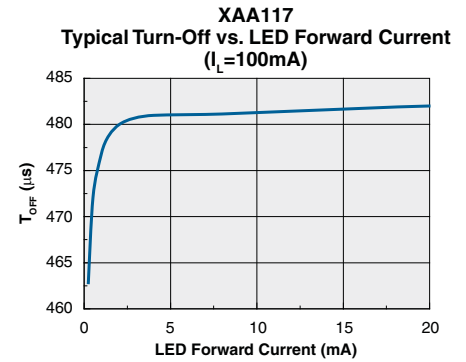
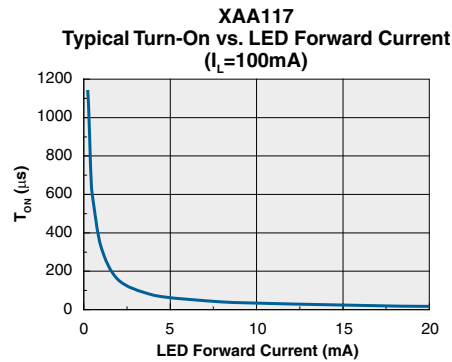
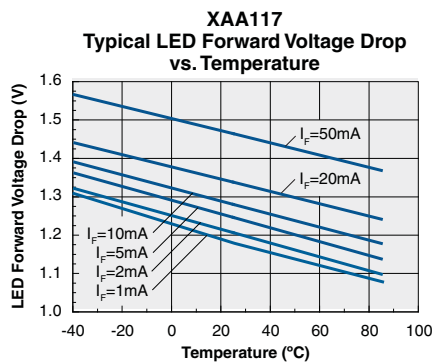
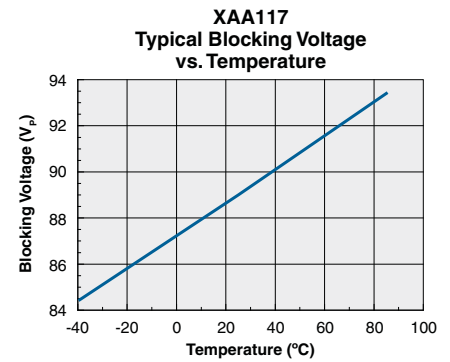
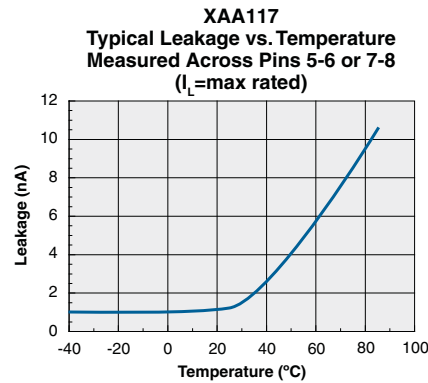
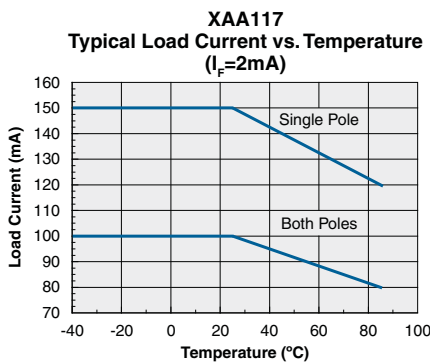
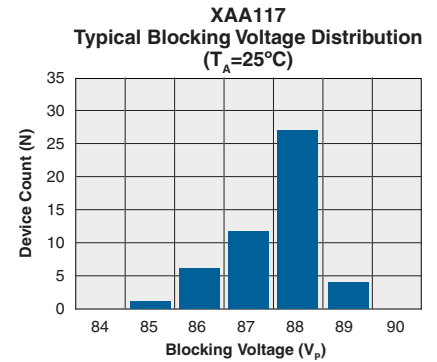
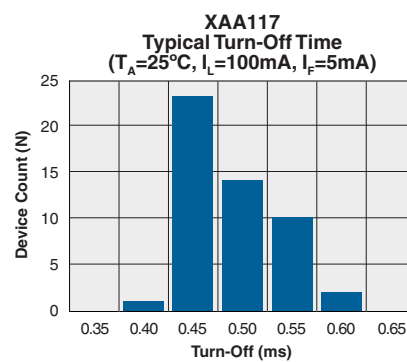
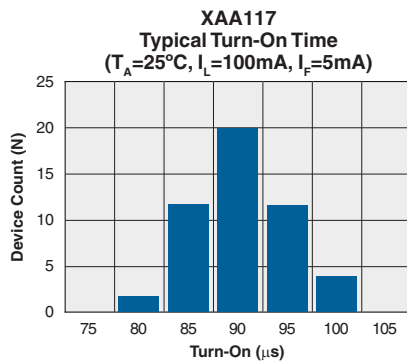
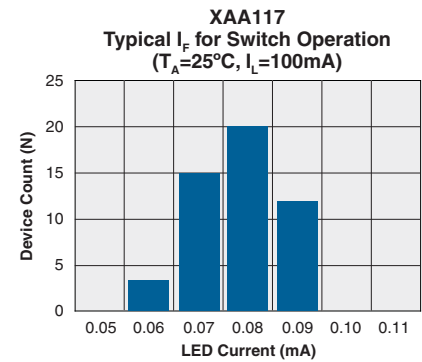
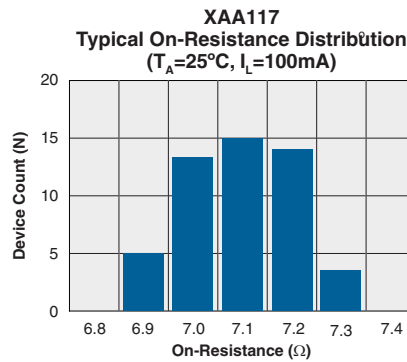
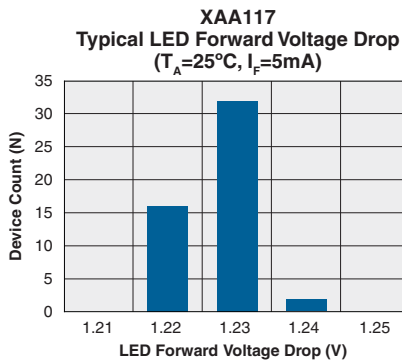

*The Performance data shown in the graphs above is typical of device performance. For guaranteed parameters not indicated in the written specifications, please contact our application department.

PERFORMANCE DATA*

XAA117
Typical On-Resistance vs. Temperature
($I_L=50\text{mA}$, $I_F=1\text{mA}$)

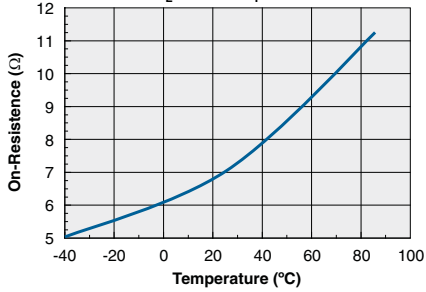

XAA117
Typical Load Current vs. Load Voltage
($T_A=25^\circ\text{C}$, $I_F=1\text{mA}$)

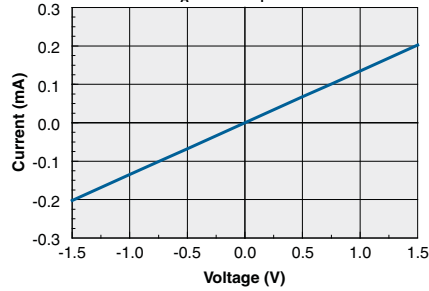

XAA117
Typical Turn-On vs. Temperature
($I_L=50\text{mA}$)

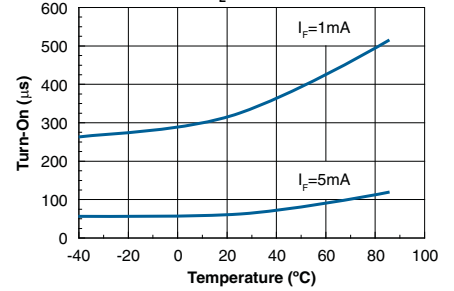

XAA117
Typical Turn-Off vs. Temperature
($I_L=50\text{mA}$)

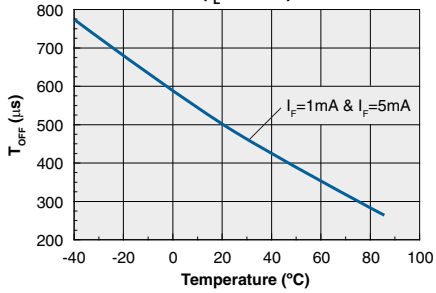

XAA117
Typical I_F to Operate vs. Temperature
($I_L=100\text{mA}$)

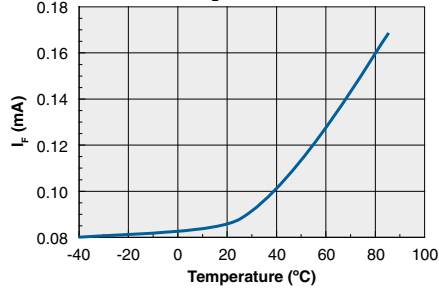

XAA117
Energy Rating Curve

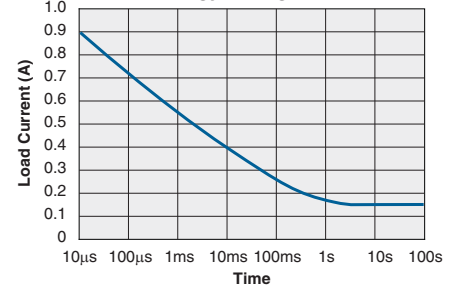

*The Performance data shown in the graphs above is typical of device performance. For guaranteed parameters not indicated in the written specifications, please contact our application department.

MANUFACTURING INFORMATION

Soldering

For proper assembly, the component must be processed in accordance with the current revision of IPC/JEDEC standard J-STD-020. Failure to follow the recommended guidelines may cause permanent damage to the device resulting in impaired performance and/or a reduced lifetime expectancy.

Washing

Clare does not recommend ultrasonic cleaning or the use of chlorinated solvents.



MECHANICAL DIMENSIONS

8-Pin DIP Through-Hole Package

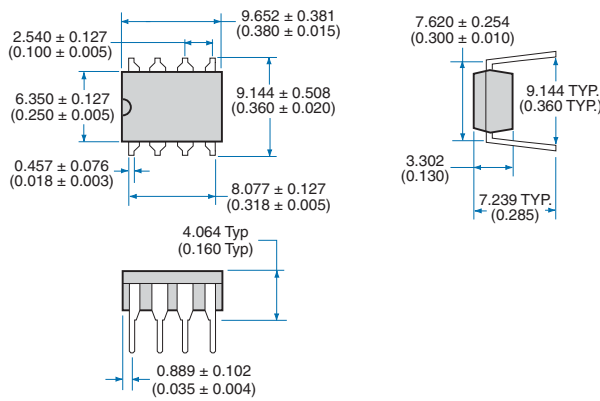

PC Board Pattern

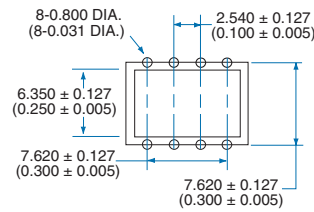

Dimensions
mm
(inches)

8-Pin Surface Mount Package

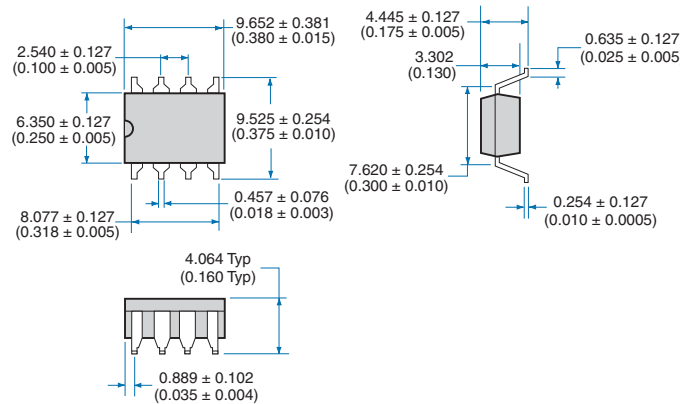

Recommended PCB Land Pattern

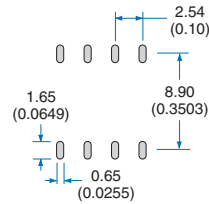

Dimensions
mm
(inches)

8 Pin Flatpack Package

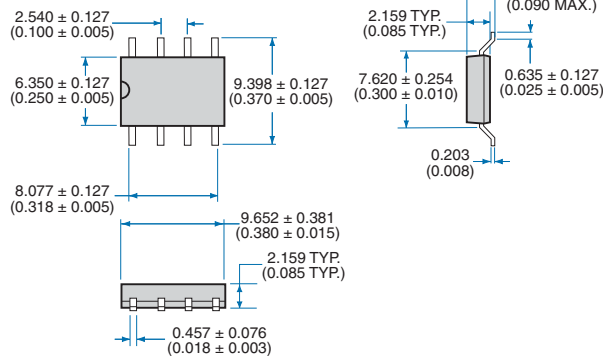

Recommended PCB Land Pattern

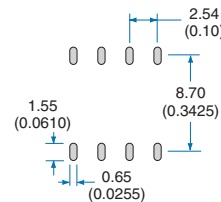

Dimensions
mm
(inches)

MECHANICAL DIMENSIONS

Tape and Reel Packaging for 8-Pin Surface Mount Package

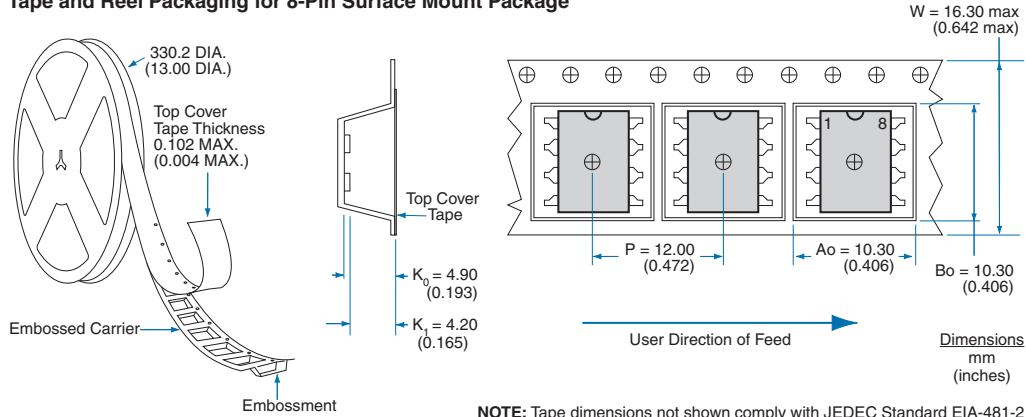

NOTE: Tape dimensions not shown comply with JEDEC Standard EIA-481-2

Tape and Reel Packaging for 8 Pin Flatpack Package

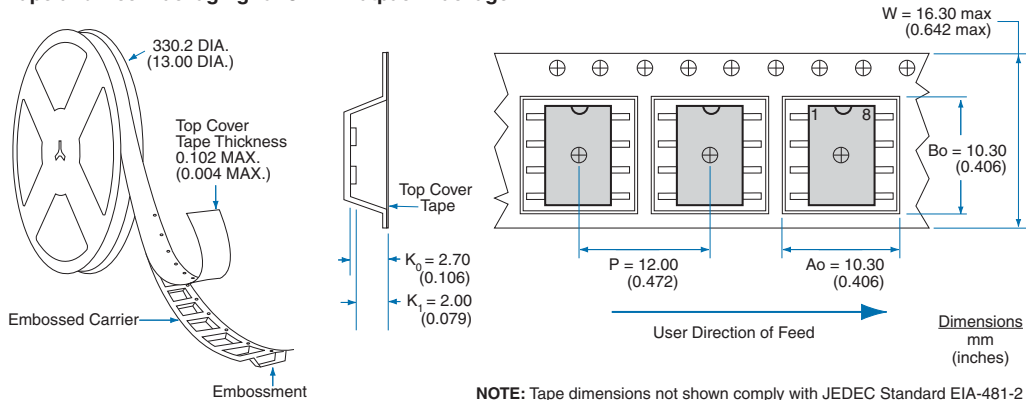

NOTE: Tape dimensions not shown comply with JEDEC Standard EIA-481-2

For additional information please visit our website at: www.clare.com

Clare, Inc. makes no representations or warranties with respect to the accuracy or completeness of the contents of this publication and reserves the right to make changes to specifications and product descriptions at any time without notice. Neither circuit patent licenses nor indemnity are expressed or implied. Except as set forth in Clare's Standard Terms and Conditions of Sale, Clare, Inc. assumes no liability whatsoever, and disclaims any express or implied warranty, relating to its products including, but not limited to, the implied warranty of merchantability, fitness for a particular purpose, or infringement of any intellectual property right.

The products described in this document are not designed, intended, authorized or warranted for use as components in systems intended for surgical implant into the body, or in other applications intended to support or sustain life, or where malfunction of Clare's product may result in direct physical harm, injury, or death to a person or severe property or environmental damage. Clare, Inc. reserves the right to discontinue or make changes to its products at any time without notice.