

High Speed Optocoupler, 1 MBd, Photodiode with Transistor Output, 110 °C Rated

Features

- Operating Temperature from -55 °C to +110 °C
- Isolation Test Voltage: 5300 V_{RMS}
- TTL Compatible
- High Bit Rates: 1.0 MBd
- Bandwidth 2.0 MHz
- Open-Collector Output
- External Base Wiring Possible
- Lead-free component
- Component in accordance to RoHS 2002/95/EC and WEEE 2002/96/EC

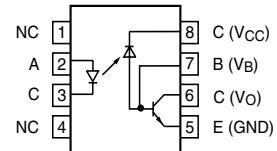
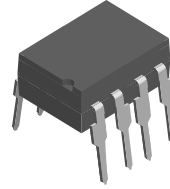

1179081



Agency Approvals

- UL 1577 - File No. E52744 System Code H or J
- DIN EN 60747-5-2 (VDE0884)
- CUL - File No. E52744, equivalent to CSA bulletin 5A

Signals can be transmitted between two electrically separated circuits up to frequencies of 2.0 MHz. The potential difference between the circuits to be coupled should not exceed the maximum permissible reference voltages

Description

The 6N1135 and 6N1136 are 110 °C rated optocouplers with a GaAlAs infrared emitting diode, optically coupled with an integrated photo detector which consists of a photo diode and a high-speed transistor in a DIP-8 plastic package.

Order Information

Part	Remarks
6N1135	CTR ≥ 7 %, DIP-8
6N1136	CTR ≥ 19 %, DIP-8
6N1135-X007	CTR ≥ 7 %, SMD-8 (option 7)
6N1136-X006	CTR ≥ 19 %, DIP-8 400 mil (option 6)
6N1136-X007	CTR ≥ 19 %, SMD-8 (option 7)
6N1136-X009	CTR ≥ 19 %, SMD-8 (option 9)

For additional information on the available options refer to Option Information.

Absolute Maximum Ratings

T_{amb} = 25 °C, unless otherwise specified

Stresses in excess of the absolute Maximum Ratings can cause permanent damage to the device. Functional operation of the device is not implied at these or any other conditions in excess of those given in the operational sections of this document. Exposure to absolute Maximum Rating for extended periods of the time can adversely affect reliability.

Input

Parameter	Test condition	Symbol	Value	Unit
Reverse voltages		V _R	5.0	V
Forward current		I _F	25	mA
Peak forward current	t = 1.0 ms, duty cycle 50 %	I _{FM}	50	mA
Maximum surge forward current	t ≤ 1.0 μs, 300 pulses/s	I _{FSM}	1.0	A
Thermal resistance		R _{th}	700	K/W
Power dissipation	T _{amb} = 70 °C	P _{diss}	45	mW

Vishay Semiconductors

Output

Parameter	Test condition	Symbol	Value	Unit
Supply voltage		V_{CC}	- 0.5 to 15	V
Output voltage		V_O	- 0.5 to 15	V
Emitter-base voltage		V_{EBO}	5.0	V
Output current		I_O	8.0	mA
Maximum output current			16	mA
Base current		I_B	5.0	mA
Thermal resistance			300	K/W
Power dissipation	$T_{amb} = 70\text{ }^\circ\text{C}$	P_{diss}	100	mW

Coupler

Parameter	Test condition	Symbol	Value	Unit
Isolation test voltage (between emitter and detector climate per DIN 50014 part 2, NOV 74)	$t = 1.0\text{ s}$	V_{ISO}	5300	V_{RMS}
Storage temperature range		T_{stg}	- 55 to + 125	$^\circ\text{C}$
Ambient temperature range		T_{amb}	- 55 to + 110	$^\circ\text{C}$
Soldering temperature	max. $\leq 10\text{ s}$, dip soldering $\geq 0.5\text{ mm}$ from case bottom	T_{sld}	260	$^\circ\text{C}$

Electrical Characteristics

$T_{amb} = 25\text{ }^\circ\text{C}$, unless otherwise specified

Minimum and maximum values are testing requirements. Typical values are characteristics of the device and are the result of engineering evaluation. Typical values are for information only and are not part of the testing requirements.

Input

Parameter	Test condition	Symbol	Min	Typ.	Max	Unit
Forward voltage	$I_F = 16\text{ mA}$	V_F		1.6	1.9	V
Breakdown voltage	$I_R = 10\text{ }\mu\text{A}$	V_{BR}	5.0			V
Reverse current	$V_R = 5.0\text{ V}$	I_R		0.5	10	μA
Capacitance	$V_R = 0\text{ V}$, $f = 1.0\text{ MHz}$	C_I		125		pF
Temperature coefficient, forward voltage	$I_F = 16\text{ mA}$	$\Delta V_F/\Delta T_A$		-1.7		mV/ $^\circ\text{C}$

Output

Parameter	Test condition	Part	Symbol	Min	Typ.	Max	Unit
Logic low supply current	$I_F = 16\text{ mA}$, V_O open, $V_{CC} = 15\text{ V}$		I_{CCL}		150		μA
Supply current, logic high	$I_F = 0\text{ mA}$, V_O open, $V_{CC} = 15\text{ V}$		I_{CCH}		0.01	1	μA
Output voltage, output low	$I_F = 16\text{ mA}$, $V_{CC} = 4.5\text{ V}$, $I_O = 1.1\text{ mA}$	6N1135	V_{OL}		0.1	0.4	V
	$I_F = 16\text{ mA}$, $V_{CC} = 4.5\text{ V}$, $I_O = 2.4\text{ mA}$	6N1136	V_{OL}		0.1	0.4	V
Output current, output high	$I_F = 0\text{ mA}$, $V_O = V_{CC} = 5.5\text{ V}$		I_{OH}		3.0	500	nA
	$I_F = 0\text{ mA}$, $V_O = V_{CC} = 15\text{ V}$		I_{OH}		0.01	1	μA

Coupler

Parameter	Test condition	Part	Symbol	Min	Typ.	Max	Unit
Capacitance (input-output)	$f = 1.0 \text{ MHz}$		C_{IO}		0.6		pF
Current Transfer Ratio	$I_F = 16 \text{ mA}, V_O = 0.4 \text{ V}, V_{CC} = 4.5 \text{ V}$	6N1135	CTR	7	16		%
		6N1136	CTR	19	35		%
	$I_F = 16 \text{ mA}, V_O = 0.5 \text{ V}, V_{CC} = 4.5 \text{ V}$	6N1135	CTR	5			%
		6N1136	CTR	15			%

Switching Characteristics

Parameter	Test condition	Part	Symbol	Min	Typ.	Max	Unit
High-low	$I_F = 16 \text{ mA}, V_{CC} = 5.0 \text{ V}, R_L = 4.1 \text{ k}\Omega$	6N1135	t_{PHL}		0.3	1.5	μs
	$I_F = 16 \text{ mA}, V_{CC} = 5.0 \text{ V}, R_L = 1.9 \text{ k}\Omega$	6N1136	t_{PHL}		0.2	0.8	μs
Low-high	$I_F = 16 \text{ mA}, V_{CC} = 5.0 \text{ V}, R_L = 4.1 \text{ k}\Omega$	6N1135	t_{PLH}		0.3	1.5	μs
	$I_F = 16 \text{ mA}, V_{CC} = 5.0 \text{ V}, R_L = 1.9 \text{ k}\Omega$	6N1136	t_{PLH}		0.2	0.8	μs

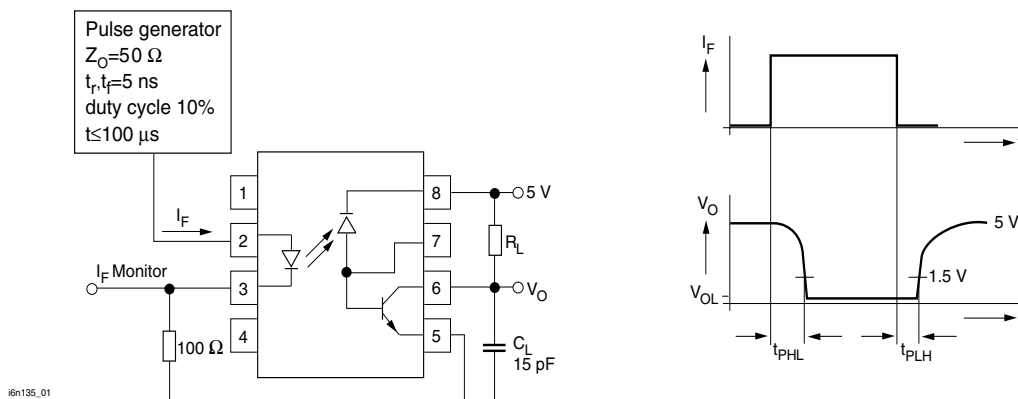

Figure 1. Switching Times

Common Mode Transient Immunity

Parameter	Test condition	Part	Symbol	Min	Typ.	Max	Unit
High	$I_F = 0 \text{ mA}, V_{CM} = 10 \text{ V}_{P-P}, V_{CC} = 5.0 \text{ V}, R_L = 4.1 \text{ k}\Omega$	6N1135	$ CM_H $		1000		$\text{V}/\mu\text{s}$
	$I_F = 0 \text{ mA}, V_{CM} = 10 \text{ V}_{P-P}, V_{CC} = 5.0 \text{ V}, R_L = 1.9 \text{ k}\Omega$	6N1136	$ CM_H $		1000		$\text{V}/\mu\text{s}$
Low	$I_F = 16 \text{ mA}, V_{CM} = 10 \text{ V}_{P-P}, V_{CC} = 5.0 \text{ V}, R_L = 4.1 \text{ k}\Omega$	6N1135	$ CM_L $		1000		$\text{V}/\mu\text{s}$
	$I_F = 16 \text{ mA}, V_{CM} = 10 \text{ V}_{P-P}, V_{CC} = 5.0 \text{ V}, R_L = 1.9 \text{ k}\Omega$	6N1136	$ CM_L $		1000		$\text{V}/\mu\text{s}$

6N1135/ 6N1136

Vishay Semiconductors

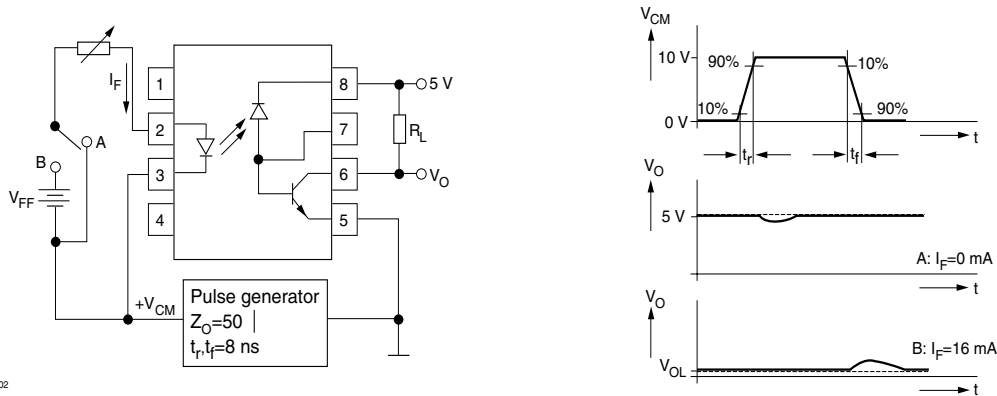

Figure 2. Common-Mode Interference Immunity

Safety and Insulation Ratings

As per IEC60747-5-2, §7.4.3.8.1, this optocoupler is suitable for "safe electrical insulation" only within the safety ratings. Compliance with the safety ratings shall be ensured by means of protective circuits.

Parameter	Test condition	Symbol	Min	Typ.	Max	Unit
Climatic Classification (according to IEC 68 part 1)				55/110/21		
Pollution degree (DIN VDE 0109)				2.0		
Comparative tracking index per DIN IEC112/VDE 0303 part 1, group IIIa per DIN VDE 6110			175		399	
V_{IOTM}		V_{IOTM}	8000			V
V_{IORM}		V_{IORM}	630			V
Isolation resistance	$V_{IO} = 500 \text{ V}, T_{amb} = 25 \text{ }^\circ\text{C}$	R_{IO}	10^{12}			Ω
	$V_{IO} = 500 \text{ V}, T_{amb} = 100 \text{ }^\circ\text{C}$	R_{IO}	10^{11}			Ω
P_{SI}		P_{SI}			500	mW
I_{SI}		I_{SI}			300	mA
T_{SI}		T_{SI}			175	$^\circ\text{C}$
Creepage			7.0			mm
Clearance			7.0			mm
Insulation thickness			0.2			mm



Typical Characteristics ($T_{amb} = 25\text{ }^{\circ}\text{C}$ unless otherwise specified)

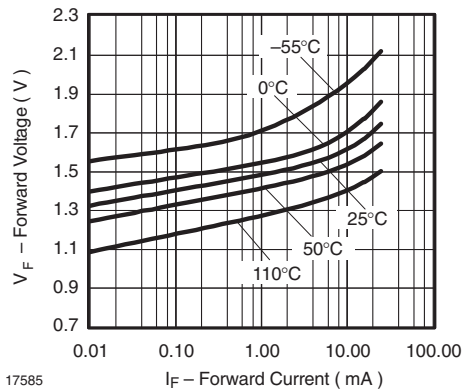

Figure 3. Forward Voltage vs. Forward Current

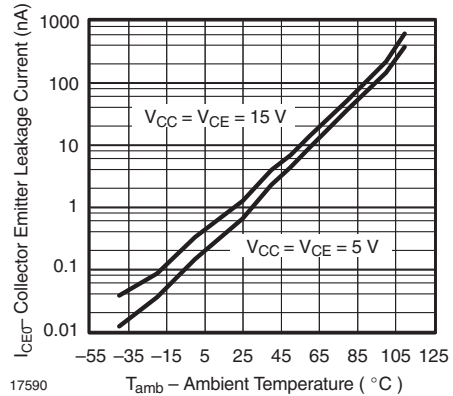

Figure 6. Collector-Emitter Dark Current vs. Ambient Temperature

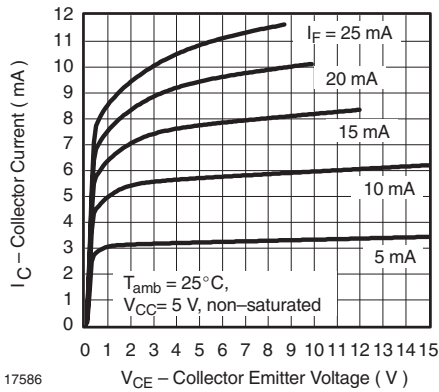

Figure 4. Collector Current vs. Collector Emitter Voltage

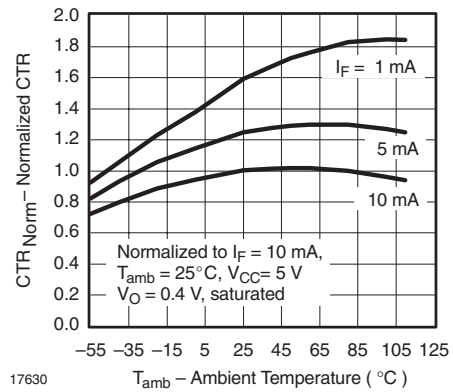

Figure 7. Normalized Current Transfer Ratio vs. Ambient Temperature

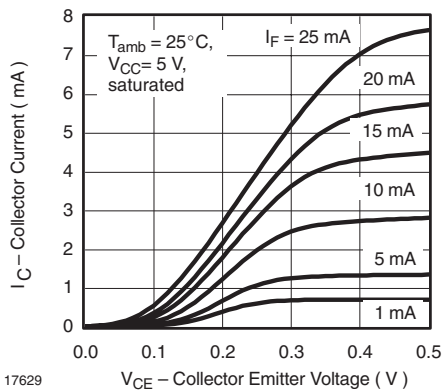

Figure 5. Collector Current vs. Collector Emitter Voltage

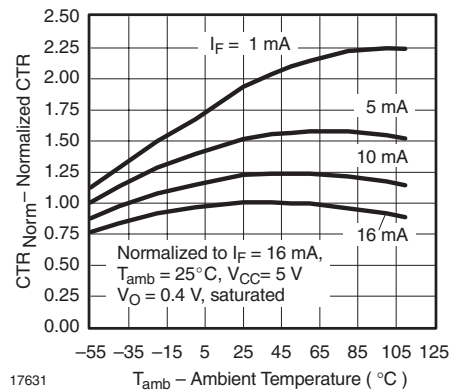

Figure 8. Normalized Current Transfer Ratio vs. Ambient Temperature

6N1135/ 6N1136

Vishay Semiconductors

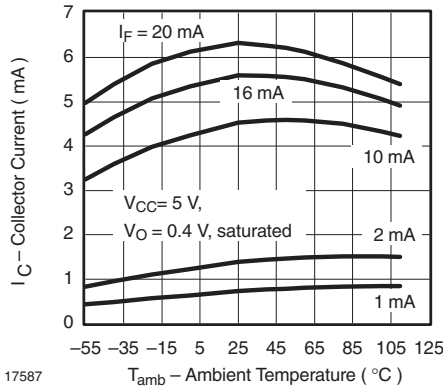

Figure 9. Output Current vs. Temperature

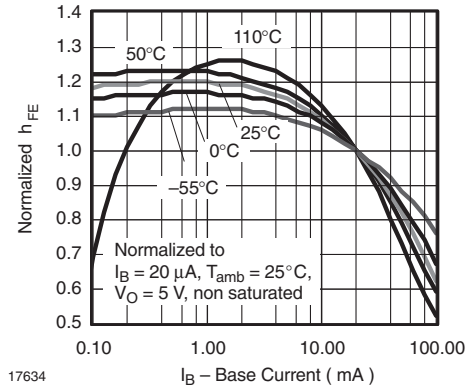

Figure 12. Normalized HFE vs. Base Current

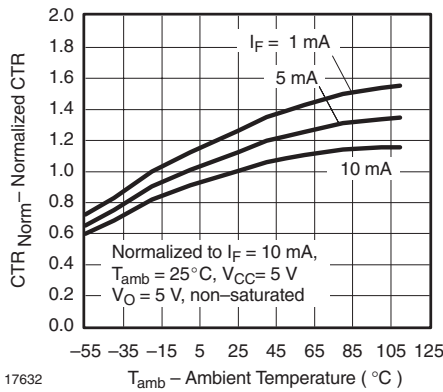

Figure 10. Normalized Current Transfer Ratio vs. Ambient Temperature

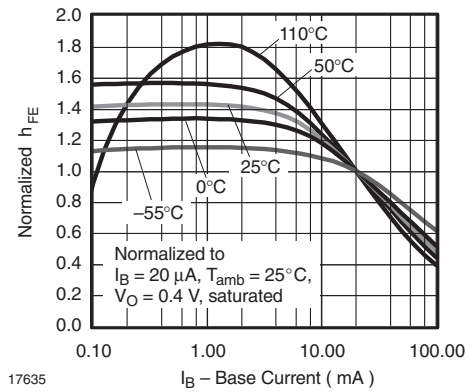

Figure 13. Normalized HFE vs. Base Current

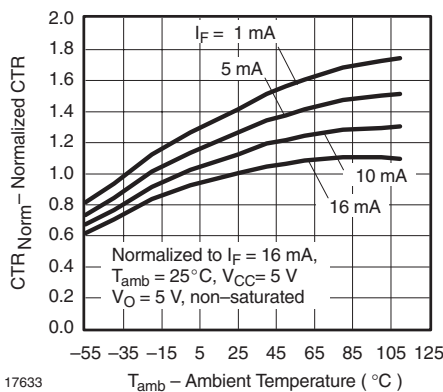

Figure 11. Normalized Current Transfer Ratio vs. Ambient Temperature

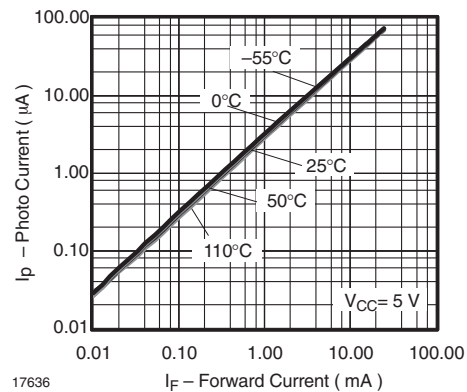

Figure 14. Photo Current vs. Forward Current

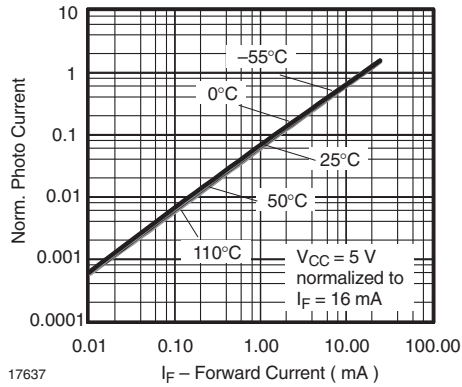

Figure 15. Photo Current vs. Forward Current

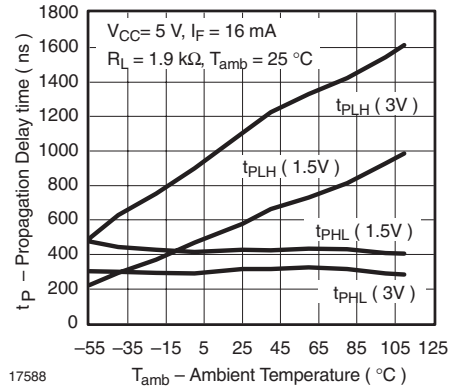

Figure 18. Propagation Delay vs. Ambient Temperature

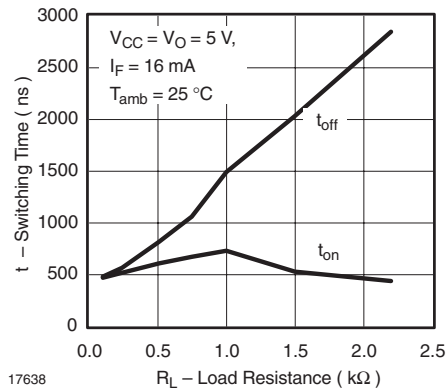

Figure 16. Switching Time vs. Load Resistance

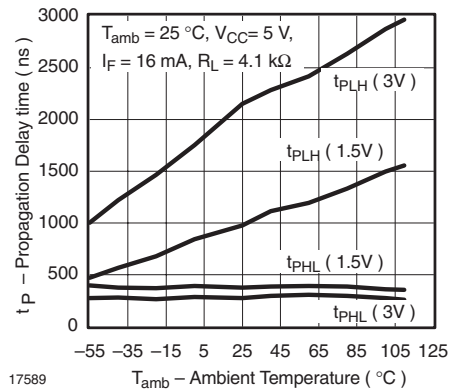

Figure 19. Propagation Delay vs. Ambient Temperature

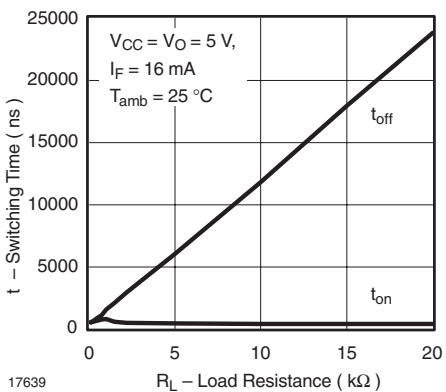

Figure 17. Switching Time vs. Load Resistance

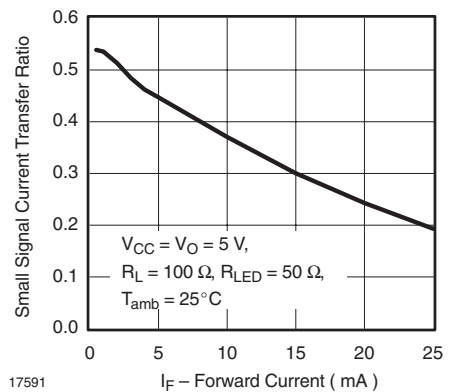

Figure 20. Small Signal CTR vs. Forward Current

6N1135/ 6N1136



Vishay Semiconductors

Figure 21. Small Signal Current Transfer Ratio vs. Quiescent Input Current

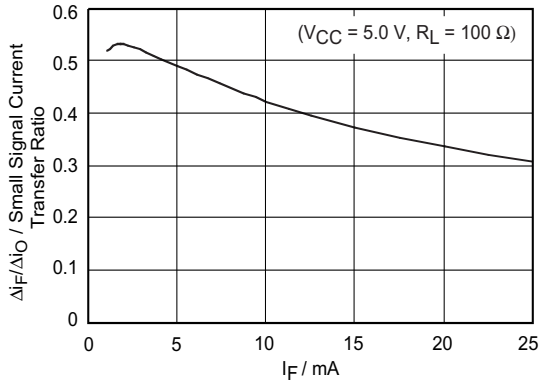

6n1135_11

Package Dimensions in Inches (mm)

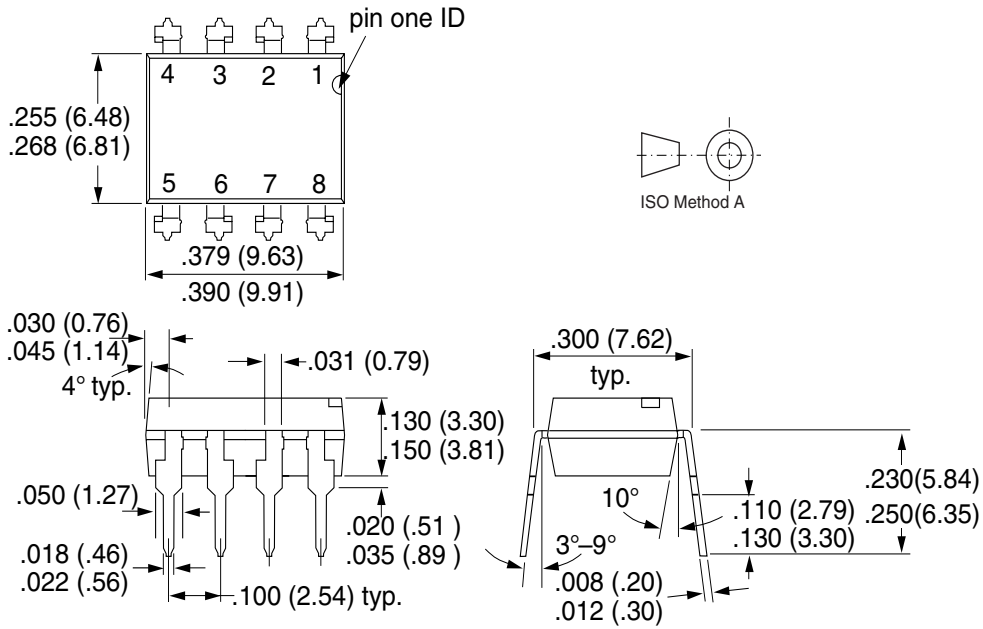

i178006

Option 6

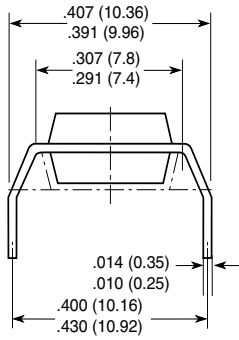

Option 7

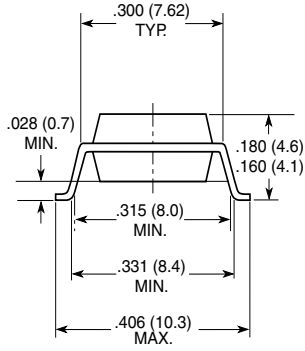

Option 9

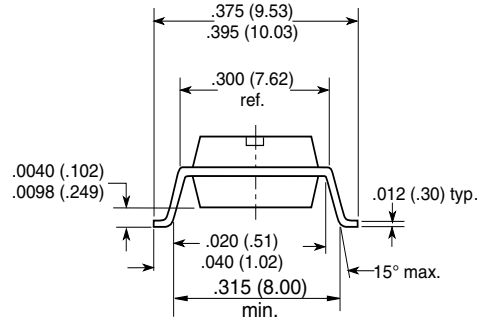

18450

**Vishay Semiconductors****Ozone Depleting Substances Policy Statement**

It is the policy of Vishay Semiconductor GmbH to

1. Meet all present and future national and international statutory requirements.
2. Regularly and continuously improve the performance of our products, processes, distribution and operating systems with respect to their impact on the health and safety of our employees and the public, as well as their impact on the environment.

It is particular concern to control or eliminate releases of those substances into the atmosphere which are known as ozone depleting substances (ODSs).

The Montreal Protocol (1987) and its London Amendments (1990) intend to severely restrict the use of ODSs and forbid their use within the next ten years. Various national and international initiatives are pressing for an earlier ban on these substances.

Vishay Semiconductor GmbH has been able to use its policy of continuous improvements to eliminate the use of ODSs listed in the following documents.

1. Annex A, B and list of transitional substances of the Montreal Protocol and the London Amendments respectively
2. Class I and II ozone depleting substances in the Clean Air Act Amendments of 1990 by the Environmental Protection Agency (EPA) in the USA
3. Council Decision 88/540/EEC and 91/690/EEC Annex A, B and C (transitional substances) respectively.

Vishay Semiconductor GmbH can certify that our semiconductors are not manufactured with ozone depleting substances and do not contain such substances.

We reserve the right to make changes to improve technical design
and may do so without further notice.

Parameters can vary in different applications. All operating parameters must be validated for each customer application by the customer. Should the buyer use Vishay Semiconductors products for any unintended or unauthorized application, the buyer shall indemnify Vishay Semiconductors against all claims, costs, damages, and expenses, arising out of, directly or indirectly, any claim of personal damage, injury or death associated with such unintended or unauthorized use.

Vishay Semiconductor GmbH, P.O.B. 3535, D-74025 Heilbronn, Germany
Telephone: 49 (0)7131 67 2831, Fax number: 49 (0)7131 67 2423