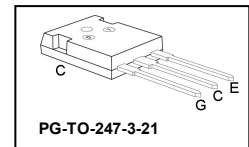
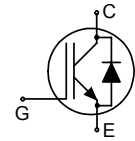

Reverse Conducting IGBT with monolithic body diode
Features:

- Powerful monolithic Body Diode with very low forward voltage
- Body diode clamps negative voltages
- TrenchStop[®] and Fieldstop technology for 1200 V applications offers :
 - very tight parameter distribution
 - high ruggedness, temperature stable behavior
- NPT technology offers easy parallel switching capability due to positive temperature coefficient in $V_{CE(sat)}$
- Low EMI
- Qualified according to JEDEC¹ for target applications
- Pb-free lead plating; RoHS compliant
- Complete product spectrum and PSpice Models : <http://www.infineon.com/igbt/>

Applications:

- Inductive Cooking
- Soft Switching Applications

Type	V_{CE}	I_C	$V_{CE(sat), T_j=25^\circ C}$	$T_{j,max}$	Marking	Package
IHW20N120R2	1200V	20A	1.55V	175°C	H20R1202	PG-TO-247-3-21

Maximum Ratings

Parameter	Symbol	Value	Unit
Collector-emitter voltage	V_{CE}	1200	V
DC collector current $T_C = 25^\circ C$ $T_C = 100^\circ C$	I_C	40 20	A
Pulsed collector current, t_p limited by T_{jmax}	$I_{C,puls}$	60	
Turn off safe operating area ($V_{CE} \leq 1200V, T_j \leq 175^\circ C$)	-	60	
Diode forward current $T_C = 25^\circ C$ $T_C = 100^\circ C$	I_F	40 20	
Diode pulsed current, t_p limited by T_{jmax}	$I_{F,puls}$	30	
Diode surge non repetitive current, t_p limited by T_{jmax} $T_C = 25^\circ C, t_p = 10ms$, sine halfwave $T_C = 25^\circ C, t_p \leq 2.5\mu s$, sine halfwave $T_C = 100^\circ C, t_p \leq 2.5\mu s$, sine halfwave	I_{FSM}	50 130 120	
Gate-emitter voltage	V_{GE}	± 20	V
Transient Gate-emitter voltage ($t_p < 5 ms$)		± 25	
Power dissipation $T_C = 25^\circ C$	P_{tot}	330	W
Operating junction temperature	T_j	-40...+175	°C
Storage temperature	T_{stg}	-55...+175	
Soldering temperature, 1.6mm (0.063 in.) from case for 10s	-	260	

¹ J-STD-020 and JESD-022

Thermal Resistance

Parameter	Symbol	Conditions	Max. Value	Unit
Characteristic				
IGBT thermal resistance, junction – case	R_{thJC}		0.45	K/W
Diode thermal resistance, junction – case	R_{thJCD}		0.45	
Thermal resistance, junction – ambient	R_{thJA}		40	

Electrical Characteristic, at $T_j = 25^\circ\text{C}$, unless otherwise specified

Parameter	Symbol	Conditions	Value			Unit
			min.	Typ.	max.	
Static Characteristic						
Collector-emitter breakdown voltage	$V_{(BR)CES}$	$V_{GE}=0V, I_C=500\mu A$	1200	-	-	V
Collector-emitter saturation voltage	$V_{CE(sat)}$	$V_{GE} = 15V, I_C=20A$ $T_j=25^\circ\text{C}$ $T_j=125^\circ\text{C}$ $T_j=175^\circ\text{C}$	- - -	1.55 1.75 1.85	1.75 - -	
Diode forward voltage	V_F	$V_{GE}=0V, I_F=20A$ $T_j=25^\circ\text{C}$ $T_j=125^\circ\text{C}$ $T_j=175^\circ\text{C}$	- - -	1.45 1.6 1.65	1.7 - -	
Gate-emitter threshold voltage	$V_{GE(th)}$	$I_C=0.5mA,$ $V_{CE}=V_{GE}$	5.1	5.8	6.4	
Zero gate voltage collector current	I_{CES}	$V_{CE}=1200V,$ $V_{GE}=0V$ $T_j=25^\circ\text{C}$ $T_j=175^\circ\text{C}$	- -	- -	5 2500	μA
Gate-emitter leakage current	I_{GES}	$V_{CE}=0V, V_{GE}=20V$	-	-	100	nA
Transconductance	g_{fs}	$V_{CE}=20V, I_C=20A$	-	14.5	-	S
Integrated gate resistor	R_{Gint}			none		Ω

Dynamic Characteristic

Input capacitance	C_{iss}	$V_{CE}=25V,$ $V_{GE}=0V,$ $f=1MHz$	-	1887	-	pF
Output capacitance	C_{oss}		-	59	-	
Reverse transfer capacitance	C_{rss}		-	47	-	
Gate charge	Q_{Gate}	$V_{CC}=960V, I_C=20A$ $V_{GE}=15V$	-	143	-	nC
Internal emitter inductance measured 5mm (0.197 in.) from case	L_E		-	13	-	nH

Switching Characteristic, Inductive Load, at $T_j=25^\circ C$

Parameter	Symbol	Conditions	Value			Unit
			min.	typ.	Max.	
IGBT Characteristic						
Turn-off delay time	$t_{d(off)}$	$T_j=25^\circ C,$ $V_{CC}=600V, I_C=20A$ $V_{GE}=0 / 15V,$ $R_G=15\Omega,$ $L_\sigma^{(2)}=180nH,$ $C_\sigma^{(2)}=39pF$	-	359	-	ns
Fall time	t_f		-	53	-	
Turn-on energy	E_{on}		-	-	-	
Turn-off energy	E_{off}		-	1.2	-	
Total switching energy	E_{ts}		-	1.2	-	mJ

Switching Characteristic, Inductive Load, at $T_j=175^\circ C$

Parameter	Symbol	Conditions	Value			Unit
			min.	Typ.	Max.	
IGBT Characteristic						
Turn-off delay time	$t_{d(off)}$	$T_j=175^\circ C$ $V_{CC}=600V, I_C=20A,$ $V_{GE}= 0 / 15V,$ $R_G= 15\Omega,$ $L_\sigma=180nH^{(2)},$ $C_\sigma=39pF^{(2)}$	-	427	-	ns
Fall time	t_f		-	99	-	
Turn-on energy	E_{on}		-	-	-	
Turn-off energy	E_{off}		-	2.0	-	
Total switching energy	E_{ts}		-	2.0	-	mJ

²⁾ Leakage inductance L_σ and Stray capacity C_σ due to dynamic test circuit in Figure E.

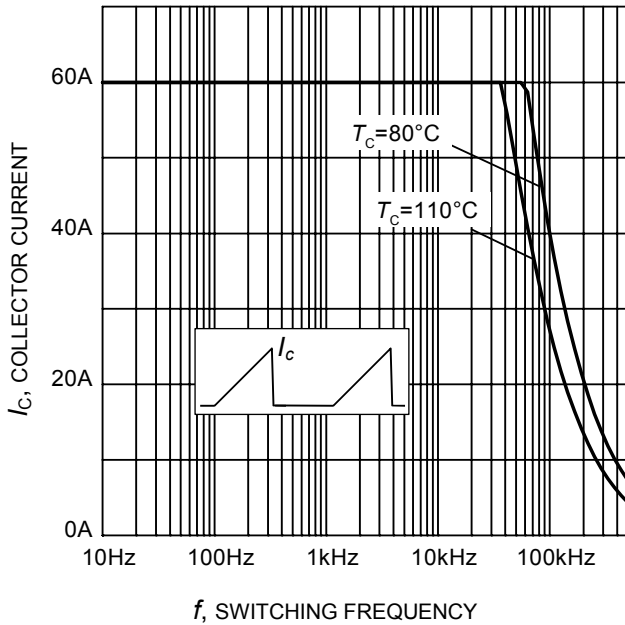

Figure 1. Collector current as a function of switching frequency for hard switching (turn-off)
 ($T_j \leq 175^\circ\text{C}$, $D = 0.5$, $V_{CE} = 600\text{V}$, $V_{GE} = 0/+15\text{V}$, $R_G = 15\Omega$)

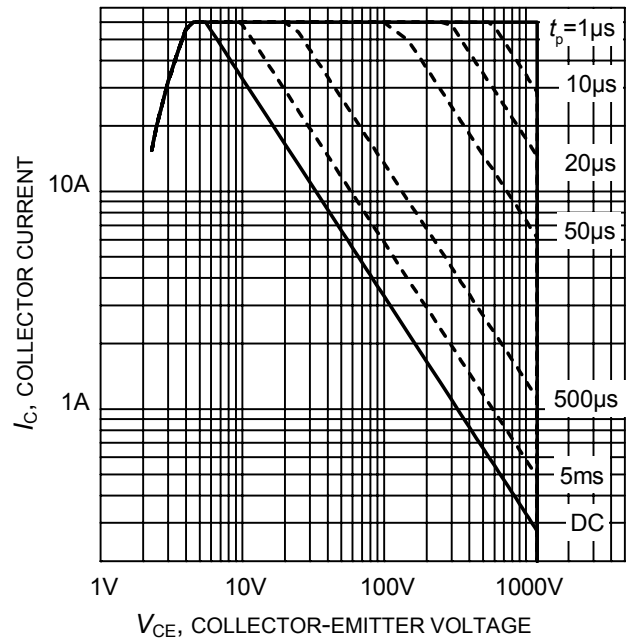

Figure 2. IGBT Safe operating area
 ($D = 0$, $T_C = 25^\circ\text{C}$, $T_j \leq 175^\circ\text{C}$; $V_{GE} = 15\text{V}$)

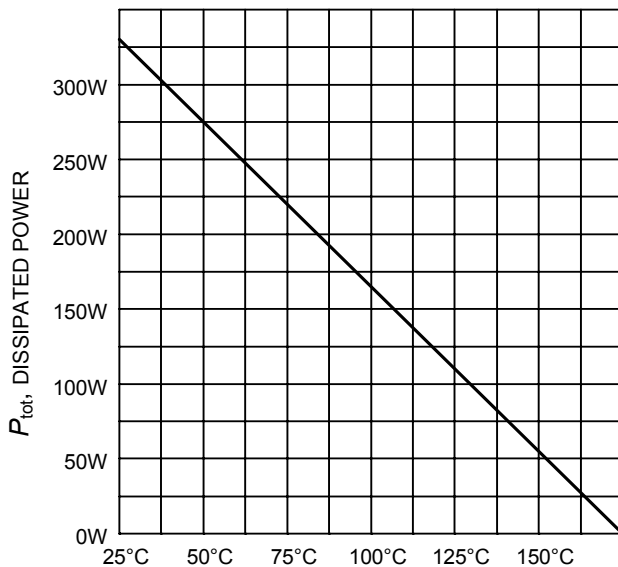

Figure 3. Power dissipation as a function of case temperature
 ($T_j \leq 175^\circ\text{C}$)

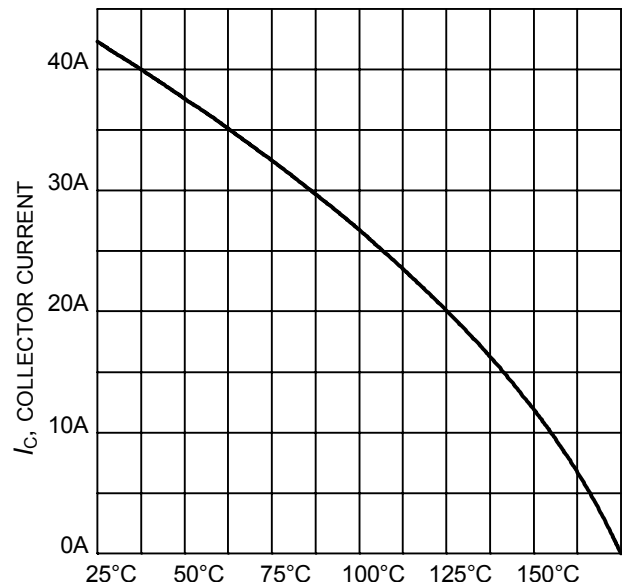

Figure 4. DC Collector current as a function of case temperature
 ($V_{GE} \geq 15\text{V}$, $T_j \leq 175^\circ\text{C}$)

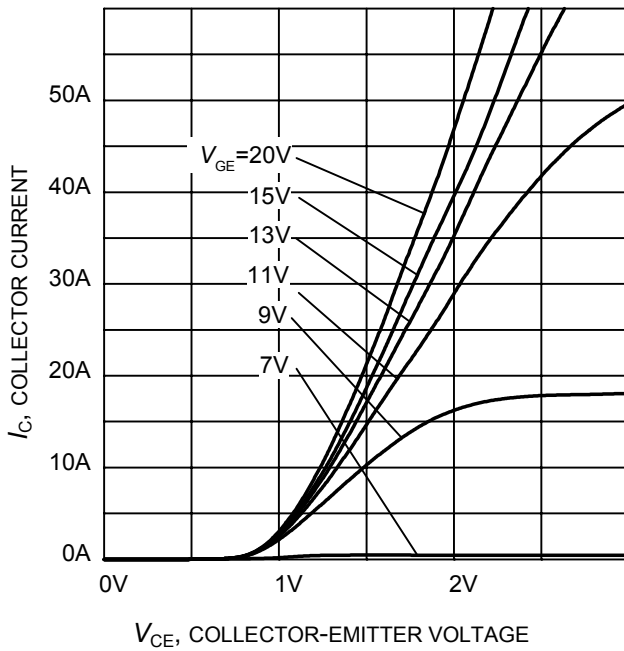

Figure 5. Typical output characteristic
($T_j = 25^\circ\text{C}$)

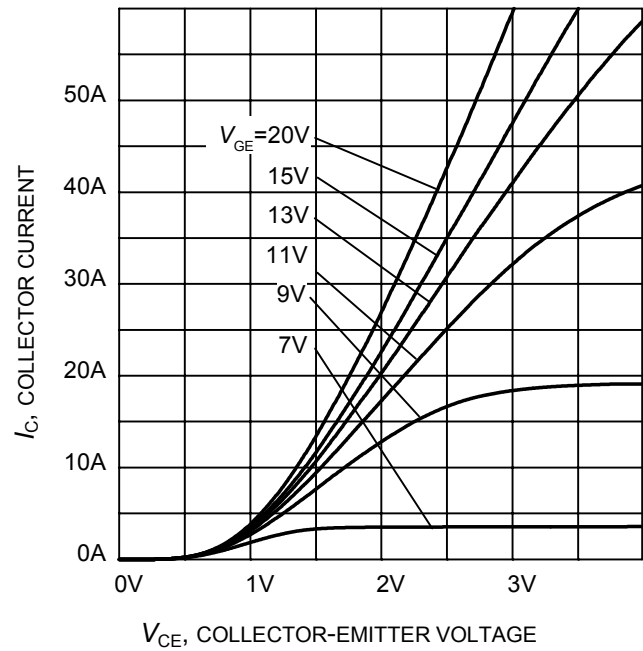

Figure 6. Typical output characteristic
($T_j = 175^\circ\text{C}$)

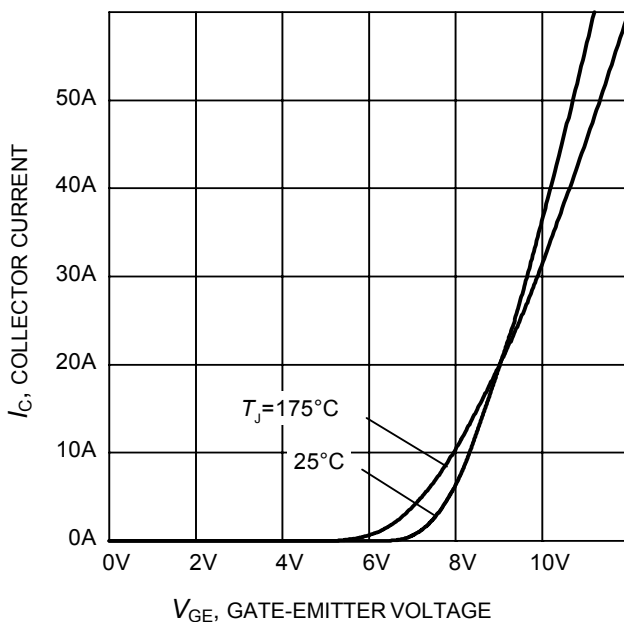

Figure 7. Typical transfer characteristic
($V_{CE} = 20\text{V}$)

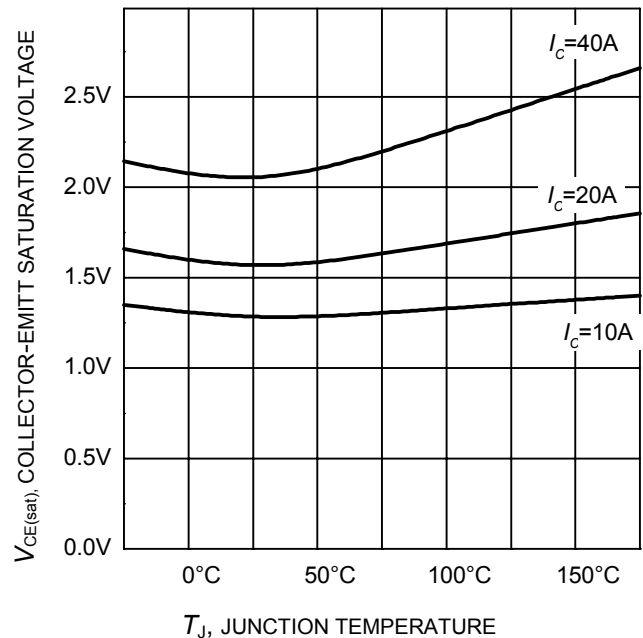

Figure 8. Typical collector-emitter saturation voltage as a function of junction temperature
($V_{GE} = 15\text{V}$)

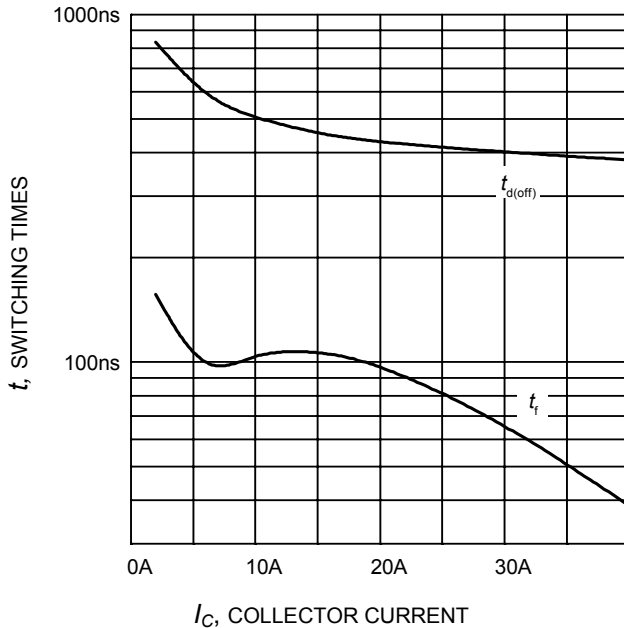

Figure 9. Typical switching times as a function of collector current
(inductive load, $T_J=175^\circ\text{C}$, $V_{CE}=600\text{V}$, $V_{GE}=0/15\text{V}$, $R_G=15\Omega$, Dynamic test circuit in Figure E)

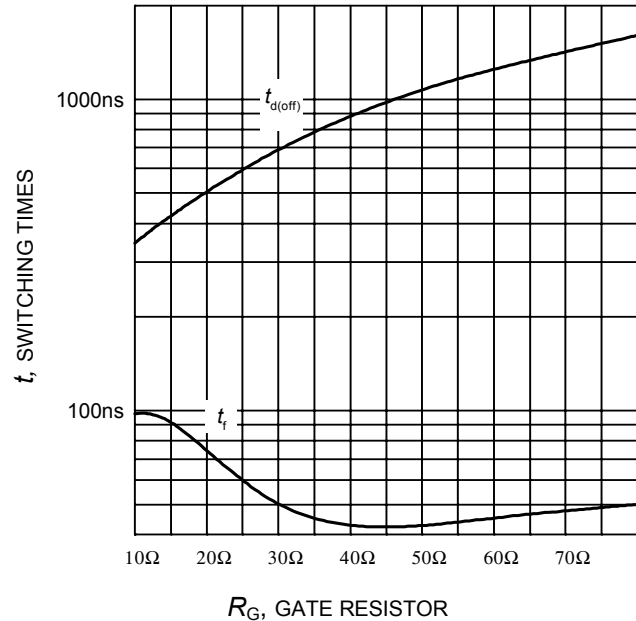

Figure 10. Typical switching times as a function of gate resistor
(inductive load, $T_J=175^\circ\text{C}$, $V_{CE}=600\text{V}$, $V_{GE}=0/15\text{V}$, $I_C=20\text{A}$, Dynamic test circuit in Figure E)

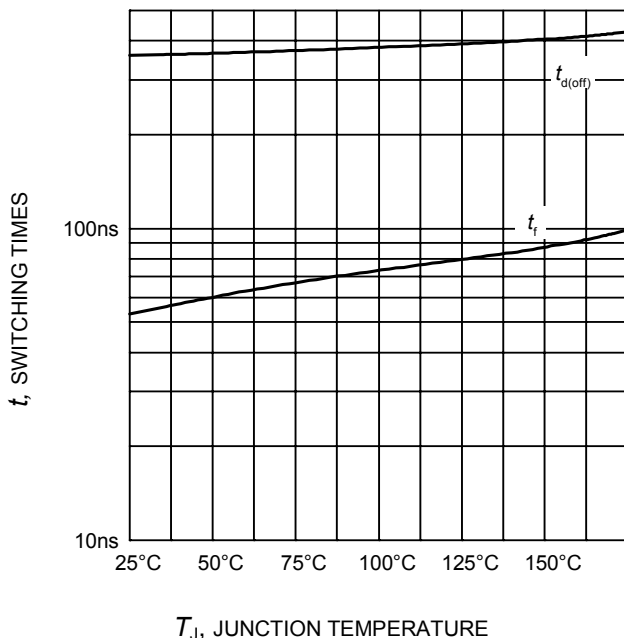

Figure 11. Typical switching times as a function of junction temperature
(inductive load, $V_{CE}=600\text{V}$, $V_{GE}=0/15\text{V}$, $I_C=20\text{A}$, $R_G=29\Omega$, Dynamic test circuit in Figure E)

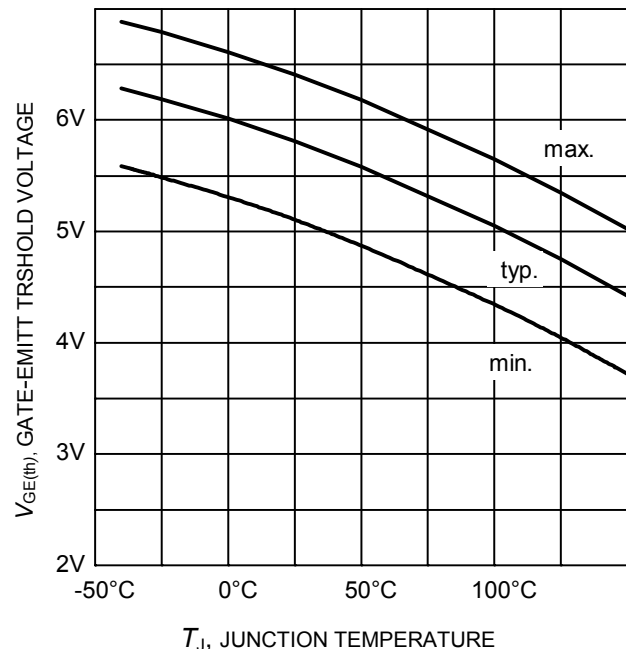

Figure 12. Gate-emitter threshold voltage as a function of junction temperature
($I_C = 0.5\text{mA}$)

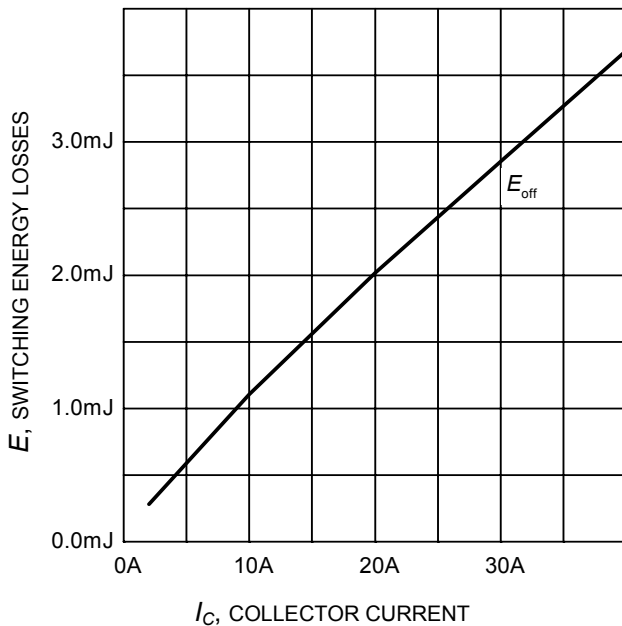

Figure 13. Typical turn-off energy as a function of collector current
(inductive load, $T_J=175^\circ\text{C}$, $V_{CE}=600\text{V}$, $V_{GE}=0/15\text{V}$, $R_G=15\Omega$, Dynamic test circuit in Figure E)

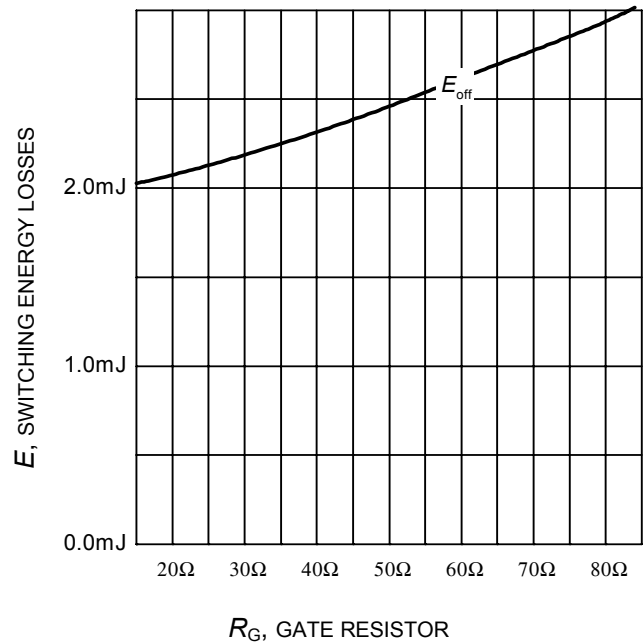

Figure 14. Typical turn-off energy as a function of gate resistor
(inductive load, $T_J=175^\circ\text{C}$, $V_{CE}=600\text{V}$, $V_{GE}=0/15\text{V}$, $I_C=20\text{A}$, Dynamic test circuit in Figure E)

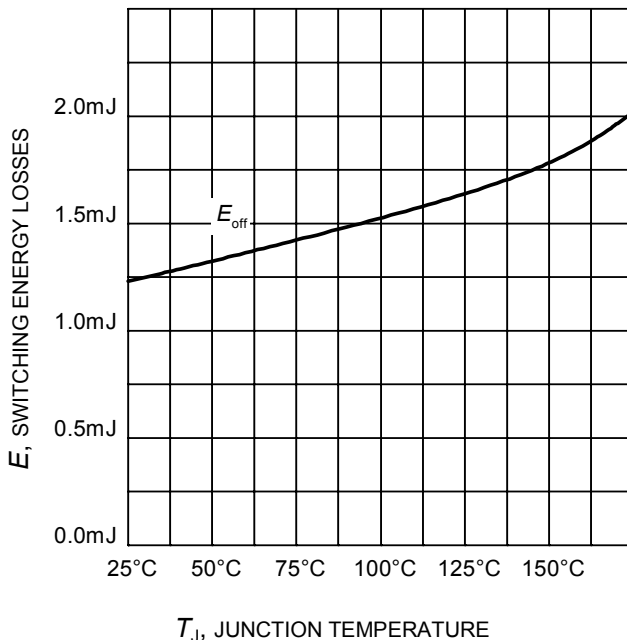

Figure 15. Typical turn-off energy as a function of junction temperature
(inductive load, $V_{CE}=600\text{V}$, $V_{GE}=0/15\text{V}$, $I_C=20\text{A}$, $R_G=15\Omega$, Dynamic test circuit in Figure E)

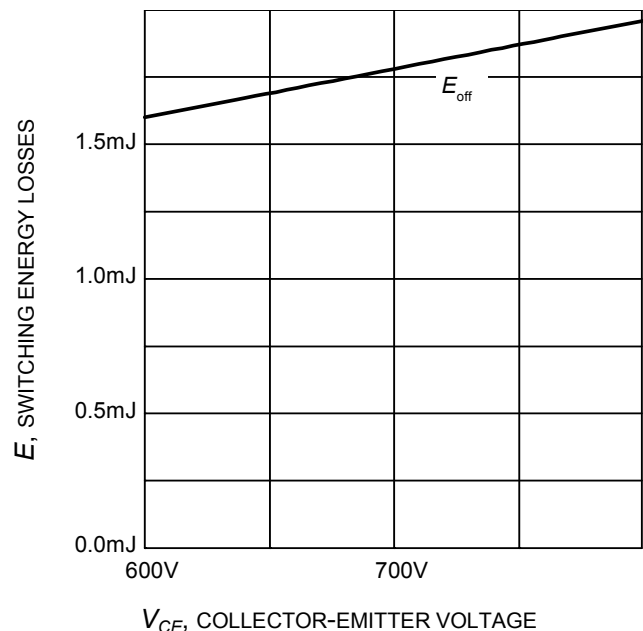

Figure 16. Typical turn-off energy as a function of collector emitter voltage
(inductive load, $T_J=175^\circ\text{C}$, $V_{GE}=0/15\text{V}$, $I_C=20\text{A}$, $R_G=15\Omega$, Dynamic test circuit in Figure E)

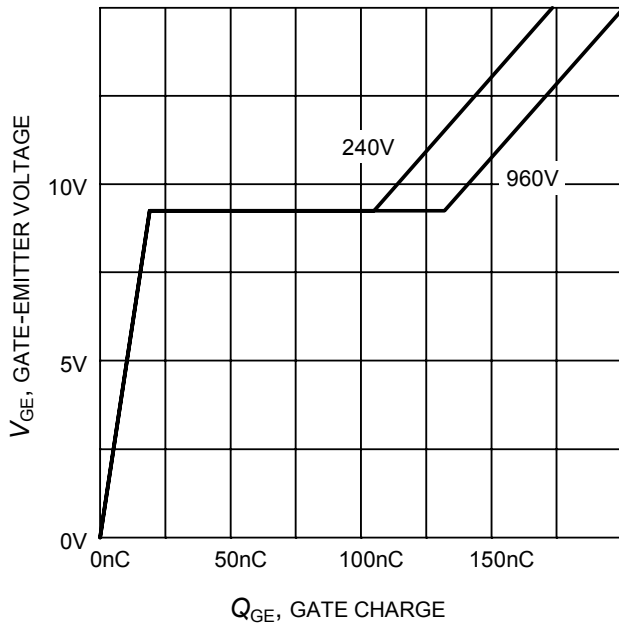

Figure 17. Typical gate charge
($I_C=20\text{ A}$)

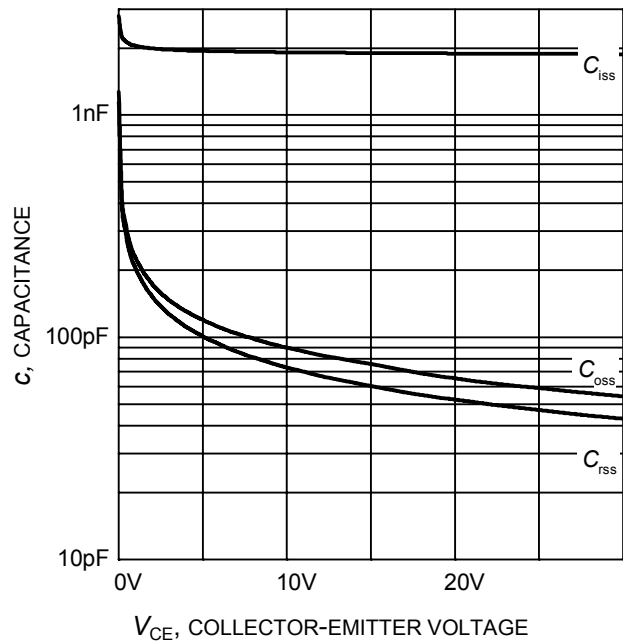

Figure 18. Typical capacitance as a function of collector-emitter voltage
($V_{GE}=0\text{V}$, $f = 1\text{ MHz}$)

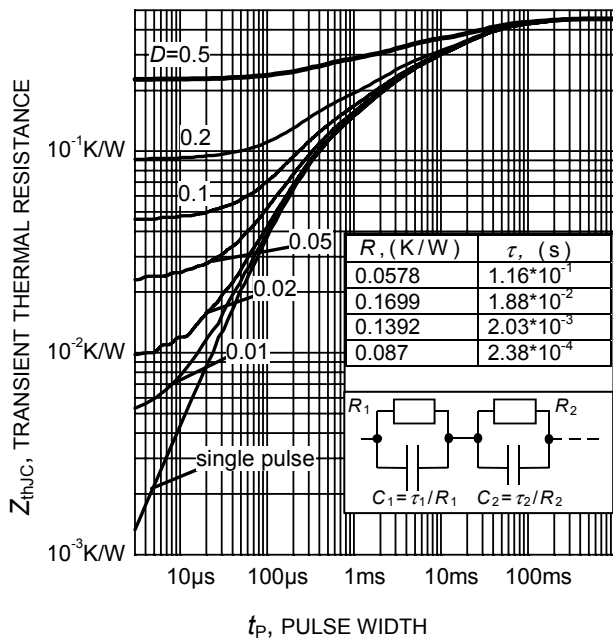

Figure 19. IGBT transient thermal resistance
($D = t_p / T$)

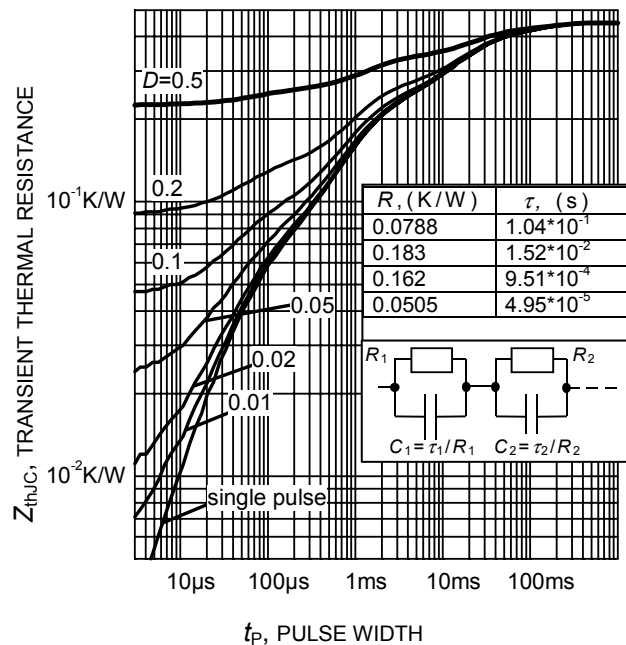

Figure 20. Diode transient thermal impedance as a function of pulse width
($D=t_p/T$)

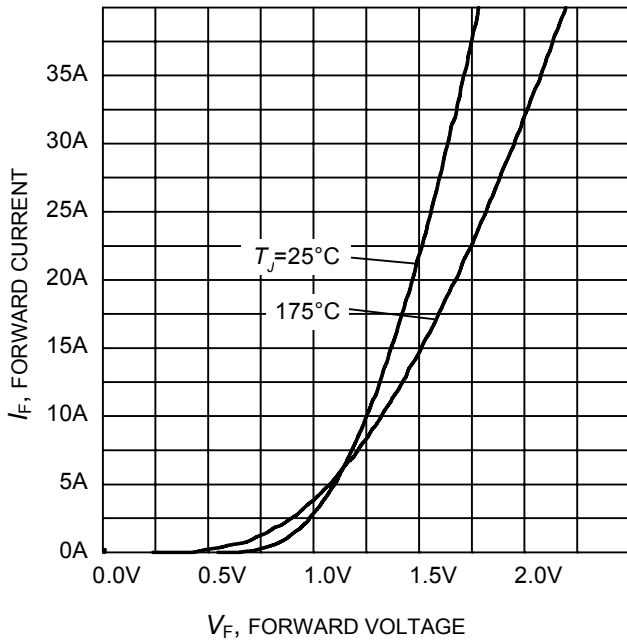

Figure 21. Typical diode forward current as a function of forward voltage

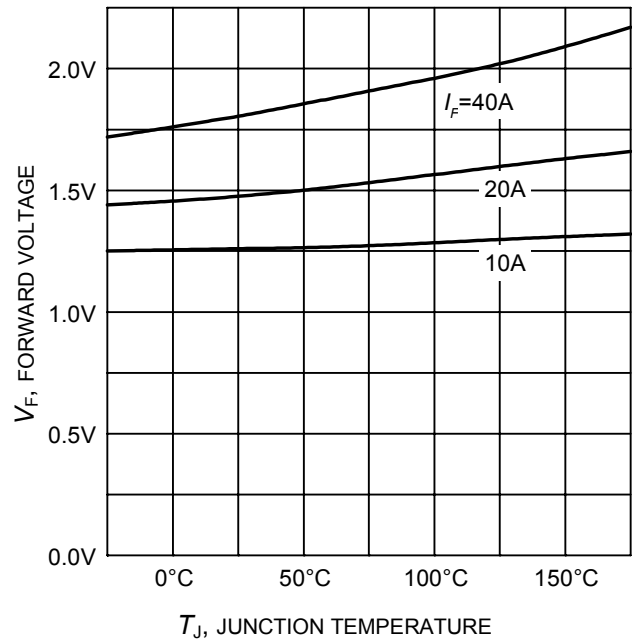
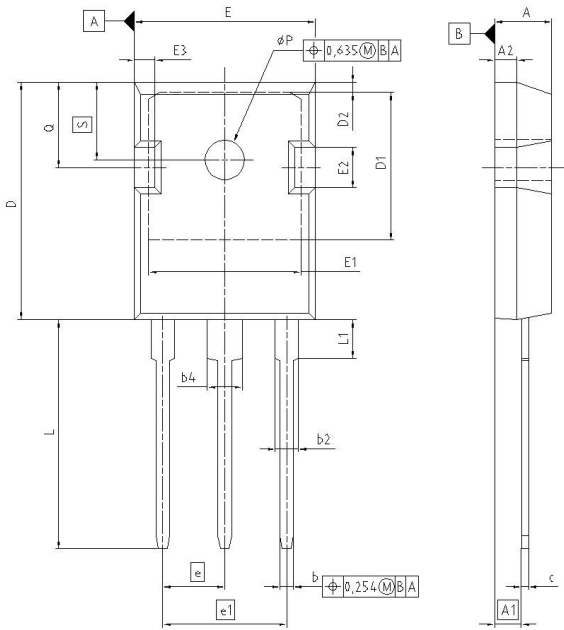

Figure 22. Typical diode forward voltage as a function of junction temperature

PG-T0247-3-21



DIM	MILLIMETERS		INCHES	
	MIN	MAX	MIN	MAX
A	4.903	5.157	0.193	0.203
A1	2.273	2.527	0.092	0.096
A2	1.853	2.107	0.075	0.081
b	1.073	1.327	0.047	0.052
b2	1.903	2.386	0.075	0.094
b4	2.870	3.454	0.113	0.136
c	0.549	0.752	0.024	0.030
D	20.823	21.077	0.820	0.830
D1	17.323	17.831	0.682	0.702
D2	1.063	1.317	0.042	0.052
E	15.773	16.027	0.621	0.631
E1	13.893	14.147	0.547	0.557
E2	3.683	3.937	0.145	0.155
E3	1.683	1.937	0.066	0.076
e	5.450		0.215	
e1	10.900		0.430	
N	3		3	
L	20.053	20.307	0.789	0.799
L1	4.168	4.472	0.164	0.176
ϕP	3.559	3.661	0.140	0.144
Q	5.493	5.747	0.216	0.226
S	6.043	6.297	0.238	0.248

Please refer to mounting instructions for assembly.

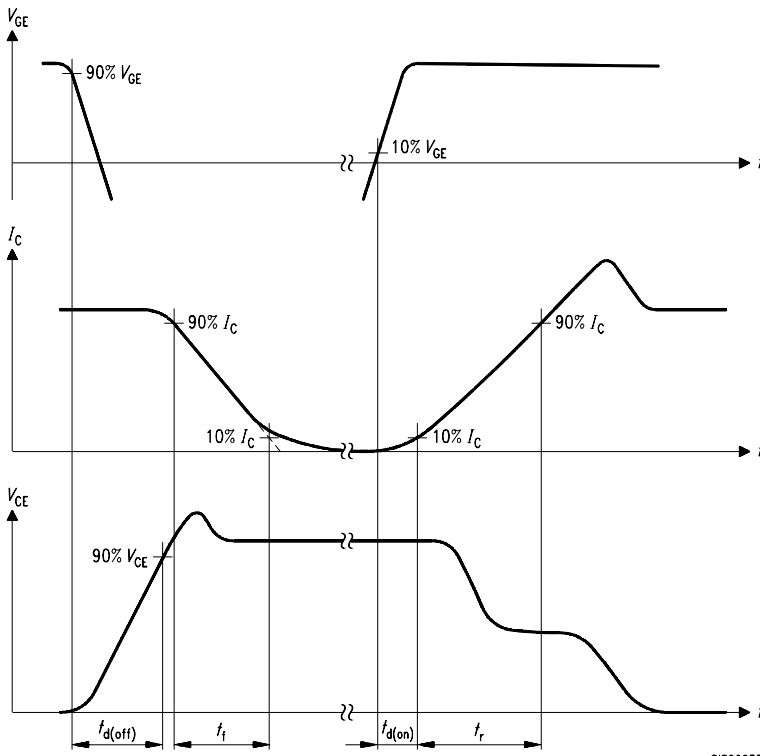

Figure A. Definition of switching times

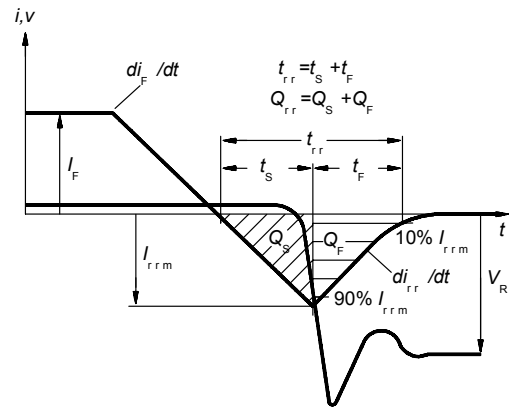

Figure C. Definition of diodes switching characteristics

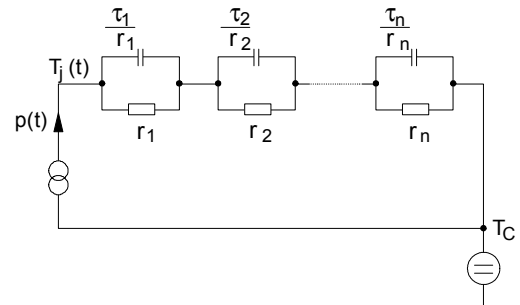

Figure D. Thermal equivalent circuit

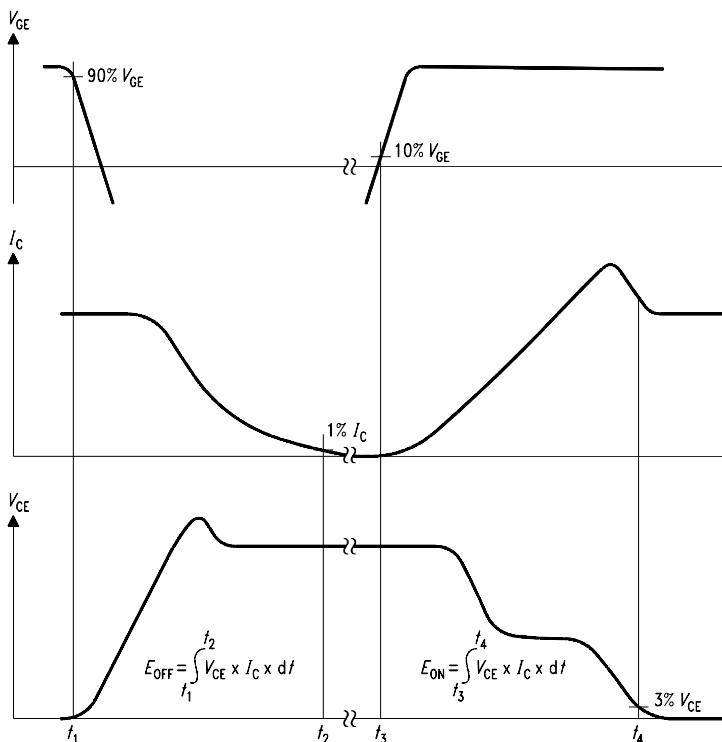

Figure B. Definition of switching losses

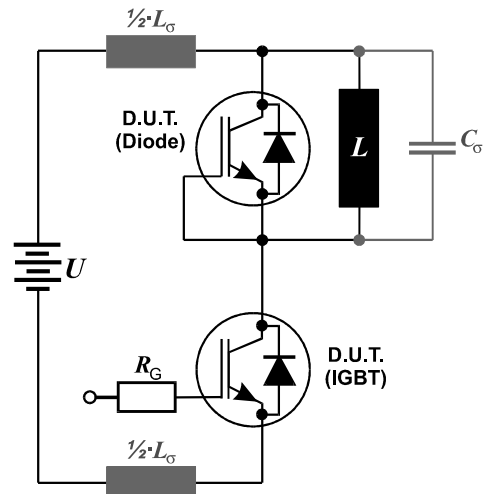

Figure E. Dynamic test circuit
Leakage inductance L_σ and Stray capacity C_σ

Edition 2006-01

**Published by
Infineon Technologies AG
81726 München, Germany**

**© Infineon Technologies AG 11/2/06.
All Rights Reserved.**

Attention please!

The information given in this data sheet shall in no event be regarded as a guarantee of conditions or characteristics ("Beschaffenheitsgarantie"). With respect to any examples or hints given herein, any typical values stated herein and/or any information regarding the application of the device, Infineon Technologies hereby disclaims any and all warranties and liabilities of any kind, including without limitation warranties of non-infringement of intellectual property rights of any third party.

Information

For further information on technology, delivery terms and conditions and prices please contact your nearest Infineon Technologies Office (www.infineon.com).

Warnings

Due to technical requirements components may contain dangerous substances. For information on the types in question please contact your nearest Infineon Technologies Office.

Infineon Technologies Components may only be used in life-support devices or systems with the express written approval of Infineon Technologies, if a failure of such components can reasonably be expected to cause the failure of that life-support device or system, or to affect the safety or effectiveness of that device or system. Life support devices or systems are intended to be implanted in the human body, or to support and/or maintain and sustain and/or protect human life. If they fail, it is reasonable to assume that the health of the user or other persons may be endangered.