

POWER RELAY

1 POLE—3, 5 A (MEDIUM LOAD CONTROL)

JY SERIES

RoHS compliant

FEATURES

- UL, CSA, VDE recognized
- High sensitivity and low power consumption
- High isolation
- Wide operating range
- DIL pitch terminals
- Plastic sealed type
- Socket mounting type and socket available
- Compatible with solid state relays type SJ (see page 365, 366) in size and pin (terminal) arrangement
- RoHS compliant since date code: 0514-
Please see page 6 for more information



ORDERING INFORMATION

JY - 12 H E - K P*2
 [Example] (a) (*) (b) (c) (d) (e) (f)

(a)	Series Name	JY : JY Series
(b)	Nominal Voltage	Refer to the COIL DATA CHART
(c)	Contact Style	Nil : 3 A (Single contact) H : 5 A (Single contact) W : 3A (Bifurcated contact)
(d)	Contact Material	Nil : Gold-plate silver cadmium oxide (single type) Nil : Gold overlay silver alloy (bifurcated) E : Silver cadmium oxide (single type)
(e)	Enclosure	K : Plastic sealed type
(f)	Terminal Classification	Nil : PC board mounting type P : Socket mounting type (without JY-W)

Note: 1. Actual marking omits the hyphen (-) of (*)
 2. Actual marking omits the P of (*2)

JY SERIES

■ COIL DATA CHART

MODEL		Nominal voltage	Coil resistance ($\pm 10\%$)	Must operate voltage*1	Must release voltage*1	Nominal power
5 A Type	3 A Type					
JY-() H, JY-() HE	JY-(), JY-() W, JY-() E					
JY- 4.5 H ()-K	JY- 4.5 ()-K	4.5 VDC	100 Ω	3.1 VDC	0.23 VDC	200 mW
JY- 5 H ()-K	JY- 5 ()-K	5 VDC	125 Ω	3.5 VDC	0.25 VDC	200 mW
JY- 6 H ()-K	JY- 6 ()-K	6 VDC	180 Ω	4.2 VDC	0.3 VDC	200 mW
JY- 9 H ()-K	JY- 9 ()-K	9 VDC	405 Ω	6.3 VDC	0.45 VDC	200 mW
JY- 12 H ()-K	JY- 12 ()-K	12 VDC	720 Ω	8.4 VDC	0.6 VDC	200 mW
JY- 18 H ()-K	JY- 18 ()-K	18 VDC	1,620 Ω	12.6 VDC	0.9 VDC	200 mW
JY- 24 H ()-K	JY- 24 ()-K	24 VDC	2,880 Ω	16.8 VDC	1.2 VDC	200 mW
JY- 48 H ()-K	JY- 48 ()-K	48 VDC	6,400 Ω	32.6 VDC	2.4 VDC	360 mW
JY-101-K		23.5 VDC	2,760 Ω	15.5 VDC	1.18 VDC	200 mW
JY-105-K		12 VDC	720 Ω	8.4 VDC	0.6 VDC	200 mW
JY-107-K		5 VDC	125 Ω	3.5 VDC	0.25 VDC	200 mW

Note: *1 Specified values are subject to pulse wave voltage.
All values in the table are measured at 20°C.

JY SERIES

■ SPECIFICATIONS

Item		3 A Type			5 A Type	
		JY-() W	JY-()	JY-() E	JY-() H	JY-() HE
Contact	Arrangement	1 form A (SPST-NO)				
	Material	Gold-overlay silver alloy	Gold-plate silver cadmium oxide	Silver cadmium oxide	Gold-plate silver cadmium oxide	Silver cadmium oxide
	Configuration	Bifurcated	Single			
	Resistance (initial) (at 1A 6 VDC)	Maximum 30 mΩ		Max. 100 mΩ	Max. 30 mΩ	Max. 100 mΩ
	Rating (resistive)	3 A 250 VAC or 3 A 30 VDC		5 A 250 VAC or 5 A 30 VDC		
	Maximum Carrying Current	5 A				
	Maximum Switching Power	750 VA, 90 W			1,250 VA, 150 W	
	Maximum Switching Voltage	250 VAC, 150 VDC				
	Maximum Switching Current	3 A			5 A (3A when used with used with socket)	
	Minimum Switching Load*1	0.1 mA 100 mVDC	10 mA 5 VDC	100 mA 5 VDC	10 mA 5 VDC	100 mA 5 VDC
Coil	Nominal Power (at 20°C)	200 mW (48 V type: 360 mW)				
	Operate Power (at 20°C)	100m W (48 V type: 170 mW)				
	Operating Temperature	-40°C to +90°C (no frost) (48V type: +80°C)				
Time Value	Operate (at nominal voltage)	Maximum 6 ms				
	Release (at nominal voltage)	Maximum 3 ms				
Insulation	Resistance (initial)	Minimum 1,000 MΩ (at 500 VDC)				
	Dielectric Strength	between open contacts	750 VAC 1 minute			
		between coil and contacts	2,000 VAC 1 minute			
Surge Strength	4,000 V (at 1.2 × 50 μs standard wave)					
Life	Mechanical	2 × 10 ⁷ operations minimum				
	Electrical	1 × 10 ⁵ operations minimum (contact rating)				
Other	Vibration	Misoperation	10 to 55 Hz (double amplitude of 1.5 mm)			
		Endurance	10 to 55 Hz (double amplitude of 4.5 mm)			
	Shock	Misoperation	100 m/s ² (11±1 ms)			
		Endurance	1,000 m/s ² (6±1 ms)			
	Weight	Approximately 5 g				

*1 Minimum switching loads mentioned above are reference values. Please perform the confirmation test with the actual load before production since reference values may vary according to switching frequencies, environmental conditions and expected reliability levels.

INSULATION

Item	5A	3A
Resistance (500VDC)	Min. 1,000 MΩ	
Dielectric strength	open contacts	750 VAC 1min.
	coil and contacts	2,000 VAC 1 min.
Surge voltage	4,000V	
	1.2 x 50μs standard wave	

SAFETY STANDARD AND FILE NUMBERS

Type	Compliance	Contact rating
UL	UL 508 E56 140	Flammability: UL94V-0 (plastics) [JY-H, JY-HE]
CSA	C22.2 No. 14 LR35579	5A, 250 VAC / 30 VDC (resistive) 1/8 HP, 125VAC, 250 VAC Pilot duty code C150 [JY, JY-W, JY-E] 3A, 250 VAC / 30 VDC (resistive) 1/10 HP, 125VAC, 250 VAC Pilot duty: C150

REFERENCE DATA

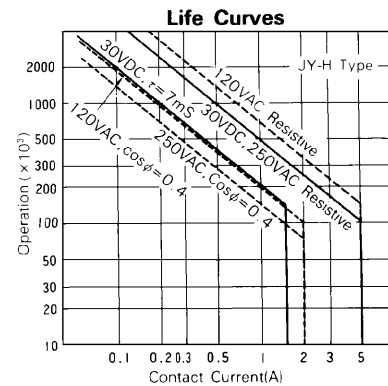
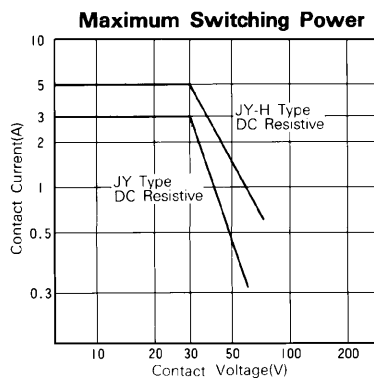
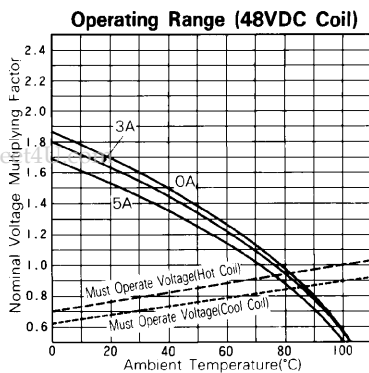
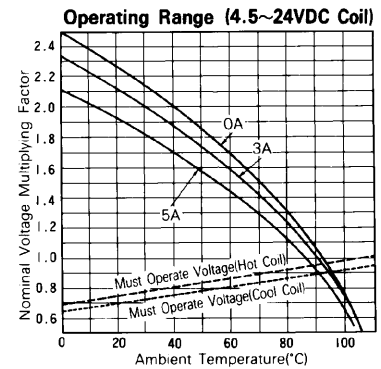
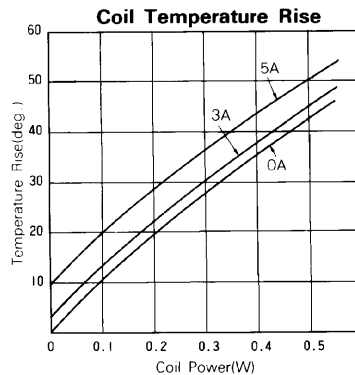
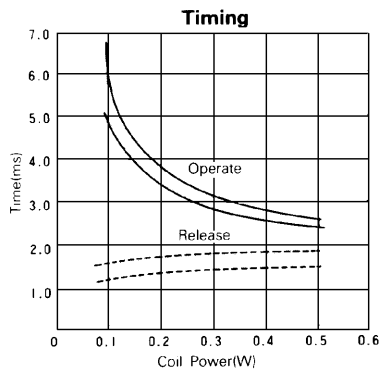

REFERENCE DATA

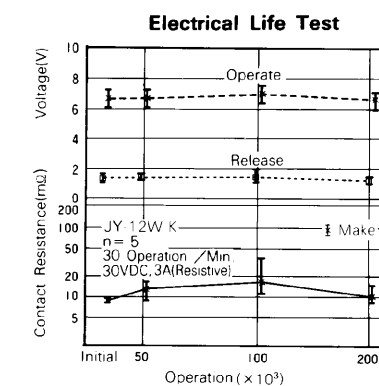
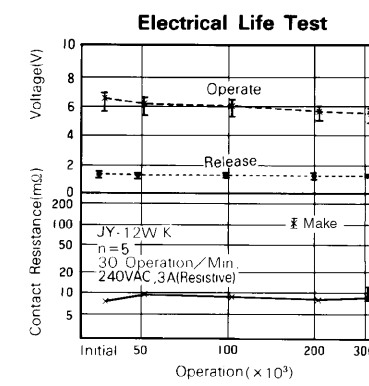
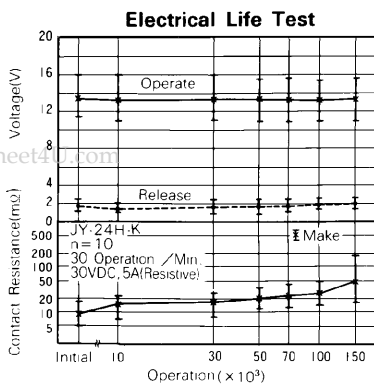
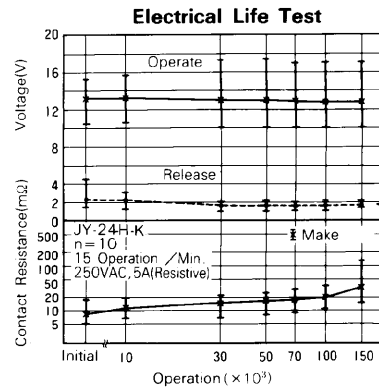
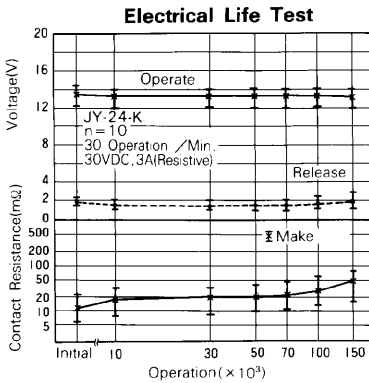
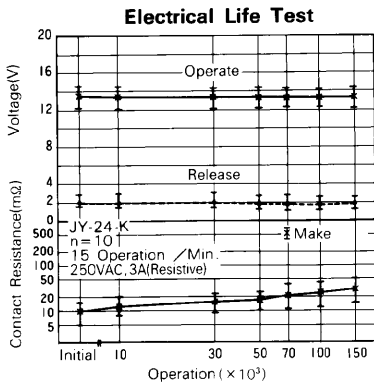
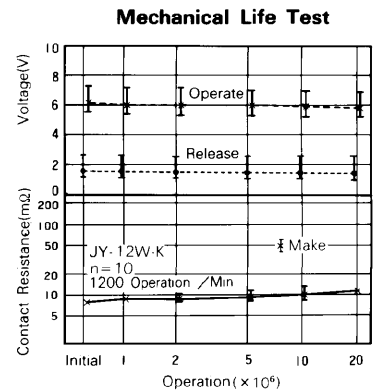
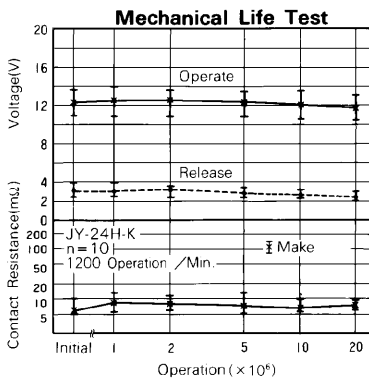
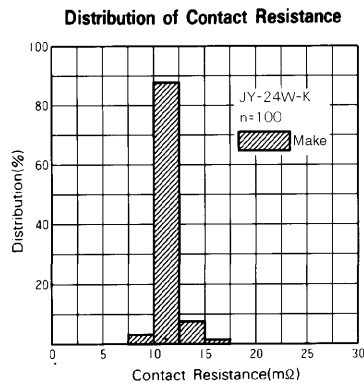
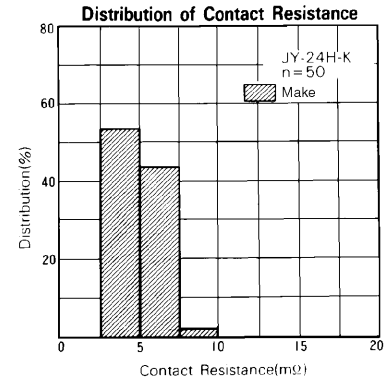
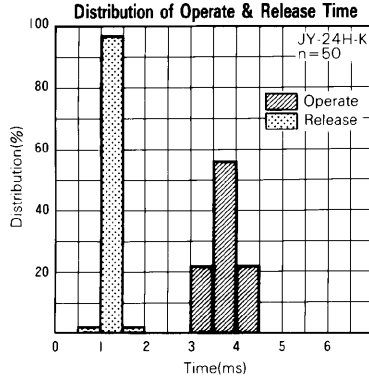
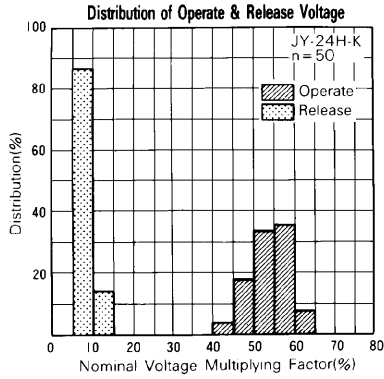

JY SERIES

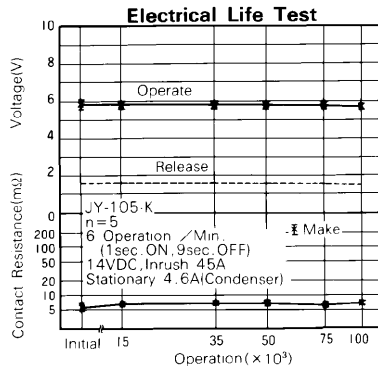

■ DIMENSIONS

● Dimensions

JY Type

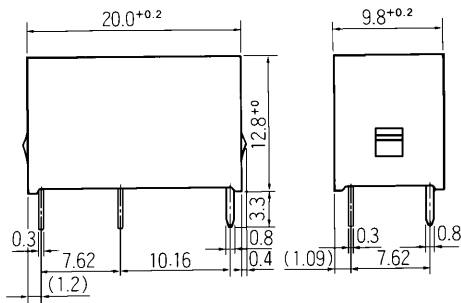

● Schematics (BOTTOM VIEW)

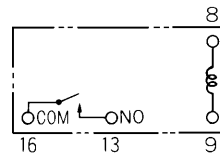

● PC board mounting hole layout (BOTTOM VIEW)

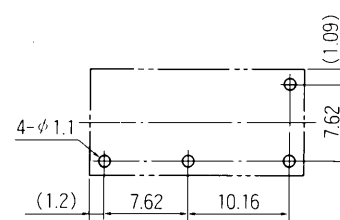

Unit: mm

■ SOCKET DIMENSIONS

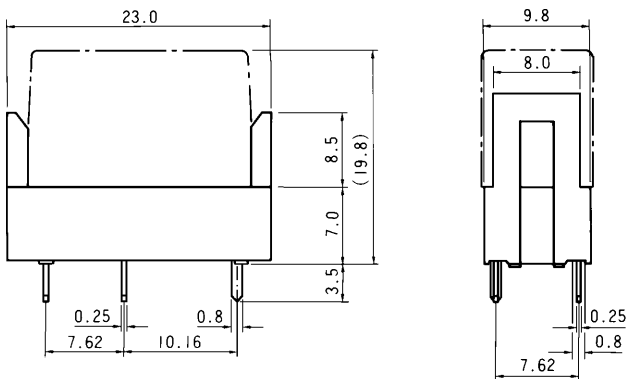

● PC board mounting hole layout

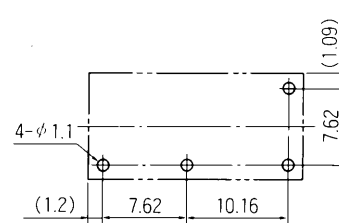

Unit: mm

www.DataSheet4U.com

■ NOTES

1. Socket ordering code : JK-4N
2. Standard IC socket is not recommended.
Please use socket "JK-4N".

RoHS Compliance and Lead Free Relay Information

1. General Information

- Relays produced after the specific date code that is indicated on each data sheet are lead-free now. All of our signal and power relays are lead-free. Please refer to Lead-Free Status Info. (<http://www.fujitsu.com/us/downloads/MICRO/fcai/relays/lead-free-letter.pdf>)
- Lead free solder paste currently used in relays is Sn-3.0Ag-0.5Cu.
- All signal and most power relays also comply with RoHS. Please refer to individual data sheets. Relays that are RoHS compliant do not contain the 5 hazardous materials that are restricted by RoHS directive (lead, mercury, chromium IV, PBB, PBDE).
- It has been verified that using lead-free relays in leaded assembly process will not cause any problems (compatible).
- "LF" is marked on each outer and inner carton. (No marking on individual relays).
- To avoid leaded relays (for lead-free sample, etc.) please consult with area sales office.
- We will ship leaded relays as long as the leaded relay inventory exists.

Note: Cadmium was exempted from RoHS on October 21, 2005. (Amendment to Directive 2002/95/EC)

2. Recommended Lead Free Solder Profile

- Recommended solder paste Sn-3.0Ag-0.5Cu.

Reflow Solder condition

Flow Solder condition:

Pre-heating: maximum 120°C
Soldering: dip within 5 sec. at
260°C solder bath

Solder by Soldering Iron:

Soldering Iron
Temperature: maximum 360°C
Duration: maximum 3 sec.

We highly recommend that you confirm your actual solder conditions

3. Moisture Sensitivity

Moisture Sensitivity Level standard is not applicable to electromechanical relays.

4. Tin Whisker

- Dipped SnAgCu solder is known as low risk tin whisker. No considerable length whisker was found by our in house test.

Fujitsu Components International Headquarter Offices

Japan

Fujitsu Component Limited
Gotanda-Chuo Building
3-5, Higashigotanda 2-chome, Shinagawa-ku
Tokyo 141, Japan
Tel: (81-3) 5449-7010
Fax: (81-3) 5449-2626
Email: promothq@ft.ed.fujitsu.com
Web: www.fcl.fujitsu.com

North and South America

Fujitsu Components America, Inc.
250 E. Caribbean Drive
Sunnyvale, CA 94089 U.S.A.
Tel: (1-408) 745-4900
Fax: (1-408) 745-4970
Email: components@us.fujitsu.com
Web: <http://us.fujitsu.com/components/>

Europe

Fujitsu Components Europe B.V.
Diamantlaan 25
2132 WV Hoofddorp
Netherlands
Tel: (31-23) 5560910
Fax: (31-23) 5560950
Email: info@fceu.fujitsu.com
Web: <http://www.fujitsu.com/emea/services/components/>

Asia Pacific

Fujitsu Components Asia Ltd.
102E Pasir Panjang Road
#04-01 Citilink Warehouse Complex
Singapore 118529
Tel: (65) 6375-8560
Fax: (65) 6273-3021
Email: fcsl@fcal.fujitsu.com
Web: <http://www.fujitsu.com/sg/services/micro/components/>

©2007 Fujitsu Components America, Inc. All rights reserved. All trademarks or registered trademarks are the property of their respective owners.

Fujitsu Components America does not warrant that the content of datasheet is error free. In a continuing effort to improve our products Fujitsu Components America, Inc. reserves the right to change specifications/datasheets without prior notice. Rev. November 30, 2007.