

TRIACS

DESCRIPTION

Glass passivated, sensitive gate triacs in a plastic envelope, intended for use in general purpose bidirectional switching and phase control applications, where high sensitivity is required in all four quadrants.

SYMBOL

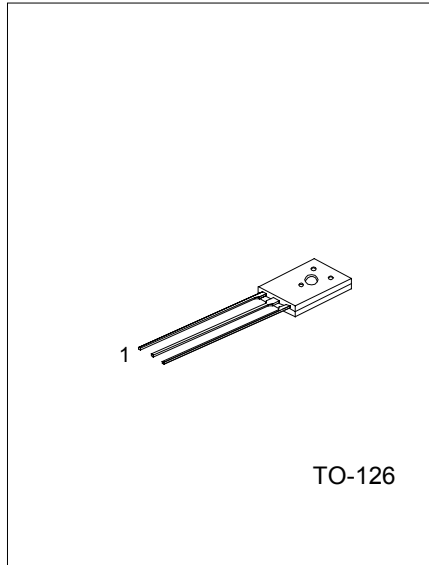
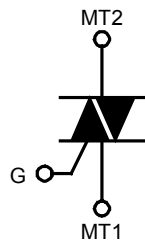

1:MT1 2:MT2 3:GATE

ABSOLUTE MAXIMUM RATINGS

PARAMETER	SYMBOL	RATINGS	UNIT
Repetitive peak off-state voltages UT134E-5 UT134E-6 UT134E-8	V _{DRM}	500 600* 800	V
RMS on-state current full sine wave; T _{mb} ≤ 107 °C	I _{T(RMS)}	4	A
Non-repetitive peak on-state current (Full sine wave; T _j = 25 °C prior to surge) t = 20ms t = 16.7 ms	I _{TSM}	25 27	A
I ² t for fusing t = 10 ms	I ² t	3.1	A ² s
Repetitive rate of rise of on-state current after triggering I _{TM} = 6 A; I _G = 0.2A; di _G / dt = 0.2A/ μ s	dI _T / dt	50 50 50 10	A/ μ s
Peak gate voltage	V _{GM}	5	V
Peak gate current	I _{GM}	2	A
Peak gate power	P _{GM}	5	W
Average gate power (over any 20 ms period)	P _{G(AV)}	0.5	W
Storage temperature	T _{stg}	-40 ~ 150	°C
Operating junction temperature	T _j	125	°C

*Although not recommended, off-state voltages up to 800V may be applied without damage, but the triac may switch to the on-state. The rate of rise of current should not exceed 3A/μs.

THERMAL RESISTANCES

PARAMETER	SYMBOL	MIN	TYP	MAX	UNIT
Thermal resistance Junction to mounting base Full cycle Half cycle	$R_{th\ j-mb}$			3.0 3.7	K/W
Thermal resistance Junction to ambient (In free air)	$R_{th\ j-a}$		100		K/W

STATIC CHARACTERISTICS ($T_j=25^\circ\text{C}$, unless otherwise stated)

PARAMETER	SYMBOL	CONDITIONS	MIN	TYP	MAX	UNIT
Gate trigger current	I_{GT}	$V_D = 12\text{ V}; I_T = 0.1\text{ A}$ T2+ G+ T2+ G- T2- G- T2- G+		2.5 4.0 5.0 11	10 10 10 25	mA
Latching current	I_L	$V_D = 12\text{ V}; I_{GT} = 0.1\text{ A}$ T2+ G+ T2+ G- T2- G- T2- G+		3.0 10 2.5 4.0	15 20 15 20	mA
Holding current	I_H	$V_D = 12\text{ V}; I_{GT} = 0.1\text{ A}$		2.2	15	mA
On-state voltage	V_T	$I_T = 5\text{ A}$		1.4	1.7	V
Gate trigger voltage	V_{GT}	$V_D = 12\text{ V}; I_T = 0.1\text{ A}$ $V_D = 400\text{ V}; I_T = 0.1\text{ A}; T_j = 125^\circ\text{C}$	0.25	0.7 0.4	1.5	V
Off-state leakage current	I_D	$V_D = V_{DRM(max)}; T_j = 125^\circ\text{C}$		0.1	0.5	mA

DYNAMIC CHARACTERISTICS ($T_j=25^\circ\text{C}$, unless otherwise stated)

PARAMETER	SYMBOL	CONDITIONS	MIN	TYP	MAX	UNIT
Critical rate of rise of Off-state voltage	dV_D/dt	$V_{DM} = 67\% V_{DRM(max)}; T_j = 125^\circ\text{C};$ exponential waveform; gate open circuit		50		V/μs
Gate controlled turn-on time	t_{gt}	$I_{TM} = 6\text{ A}; V_D = V_{DRM(max)}; I_G = 0.1\text{ A};$ $dI_G/dt = 5\text{ A}/\mu\text{s}$		2		μs

TYPICAL CHARACTERISTICS

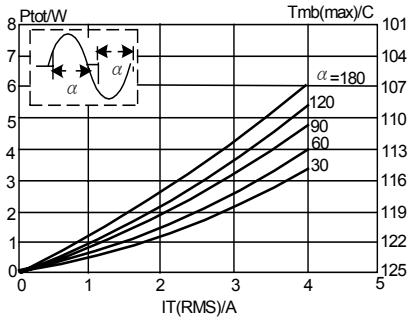

Fig.1. Maximum on-state dissipation, P_{tot} , versus rms on-state current, $I_{T(RMS)}$ where α = conduction angle.

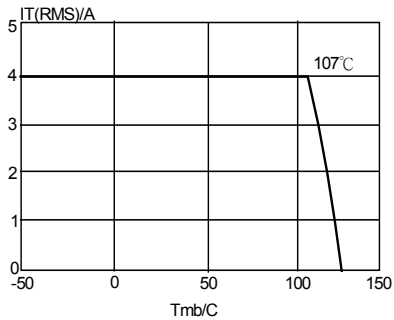

Fig.4. Maximum permissible rms current $I_{T(RMS)}$, versus mounting base temperature T_{mb}

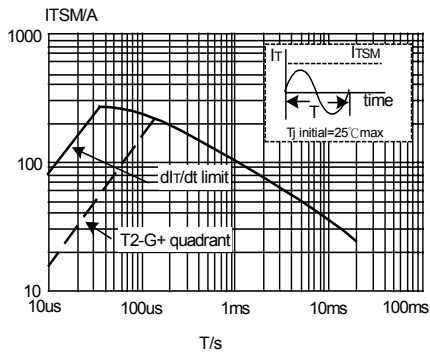

Fig.2. Maximum Permissible non-repetitive peak on-state Current I_{TSM} , versus pulse width t_p for sinusoidal currents, $t_p \leq 20ms$

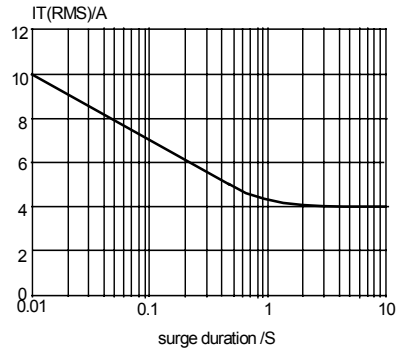

Fig. 5. Maximum permissible repetitive rms on-state current $I_{T(RMS)}$, versus surge duration, for sinusoidal currents, $f=50Hz$; $T_{mb} \leq 107^\circ C$

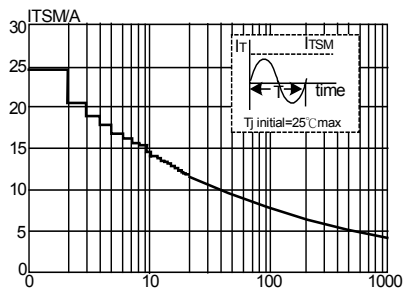

Fig.3. Maximum Permissible non-repetitive peak on-state current I_{TSM} , versus number of cycles, for sinusoidal currents, $f=50Hz$.

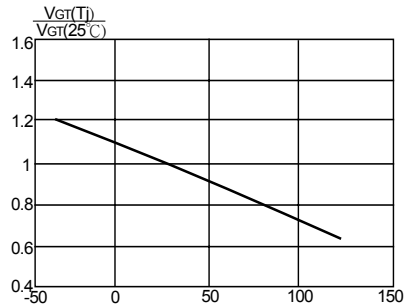

Fig.6. Normalised gate trigger voltage $V_{GT}(T_j)/V_{GT}(25^\circ C)$, versus junction temperature T_j

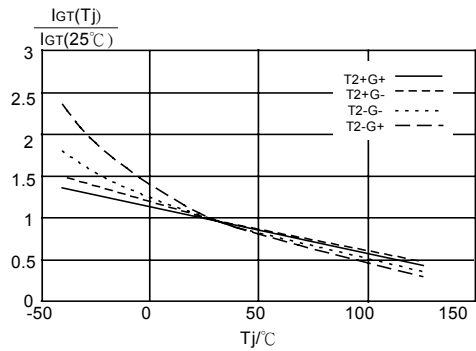

Fig. 7. Normalised gate trigger Current $I_{GT}(T_j)/I_{GT}(25^\circ\text{C})$, versus junction temperature T_j

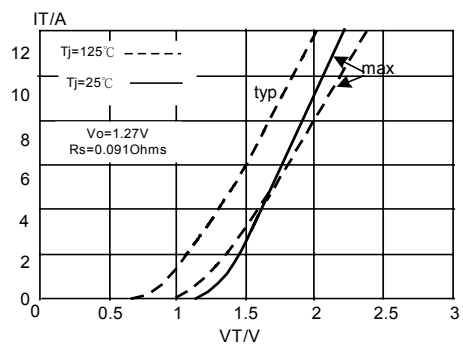

Fig. 10. Typical and maximum on-state characteristic.

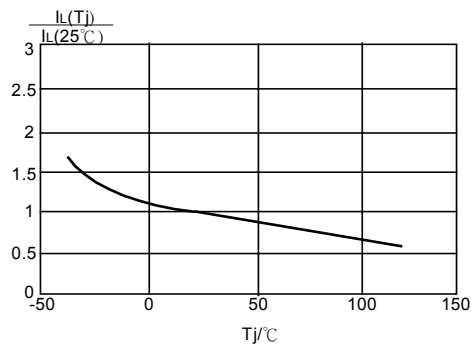

Fig. 8. Normalised latching Current $I_L(T_j)/I_L(25^\circ\text{C})$, versus junction temperature T_j

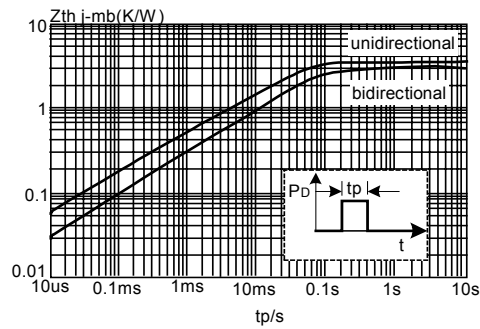

Fig. 11. Transient thermal impedance Z_{thj-mb} , versus pulse width t_p .

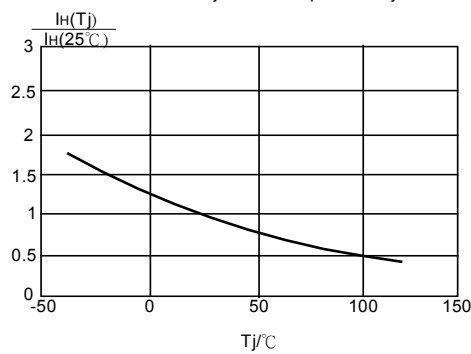

Fig. 9. Normalised holding current $I_H(T_j)/I_H(25^\circ\text{C})$, versus junction temperature T_j

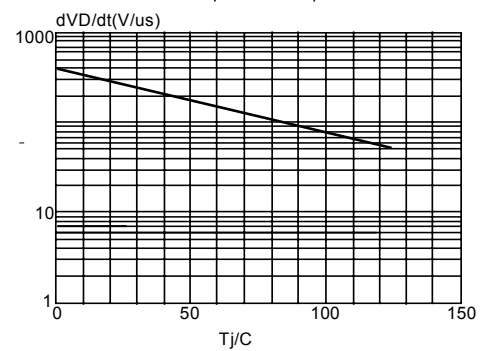

Fig. 12. Typical, critical rate of rise of off-state voltage, dV_D/dt versus junction temperature T_j

UTC assumes no responsibility for equipment failures that result from using products at values that exceed, even momentarily, rated values (such as maximum ratings, operating condition ranges, or other parameters) listed in products specifications of any and all UTC products described or contained herein. UTC products are not designed for use in life support appliances, devices or systems where malfunction of these products can be reasonably expected to result in personal injury. Reproduction in whole or in part is prohibited without the prior written consent of the copyright owner. The information presented in this document does not form part of any quotation or contract, is believed to be accurate and reliable and may be changed without notice.