

Single Channel HDMI Receiver with WideEye Equalization

FEATURES

- Single channel HDMI receiver supporting link data rate up to 1.65 Gbps
- HDMI 1.2, HDCP 1.1 and DVI 1.0 compliant
- WideEye™ architecture for signal conditioning and equalization
 - supports cable length up to 20m
 - better than 10E-12 bit error rate
- Digital interface to video processor supporting
 - 24-bit RGB / YCbCr 4:4:4
 - 16/20/24 bit YCbCr 4:2:2
 - 8/10/12 bit YCbCr 4:2:2 (ITU BT-656)
 - 12-bit double data rate interface
 - 24/48-bit single data rate interface
- Color space conversion: RGB to/from YCbCr both directions (601 and 709 standards)
- Auto video mode configuration
- Digital audio interface
 - 32 to 192 kHz audio sampling rate
 - Up to 4 I²S interface for 8-channel audio
 - S/PDIF interface supporting PCM, Dolby Digital™, DTS™ digital audio transmission using IEC 60958 and IEC61937
 - Configurable soft mute
- Integrated HDCP decryption engine and pre-programmed keys
- Programmable power management with automatic shutdown for power conservation
- Supports automated link integrity checking
- 128-lead and 144-lead QFP lead-free packages
- Pinout compatible with Silicon Image SiI9011

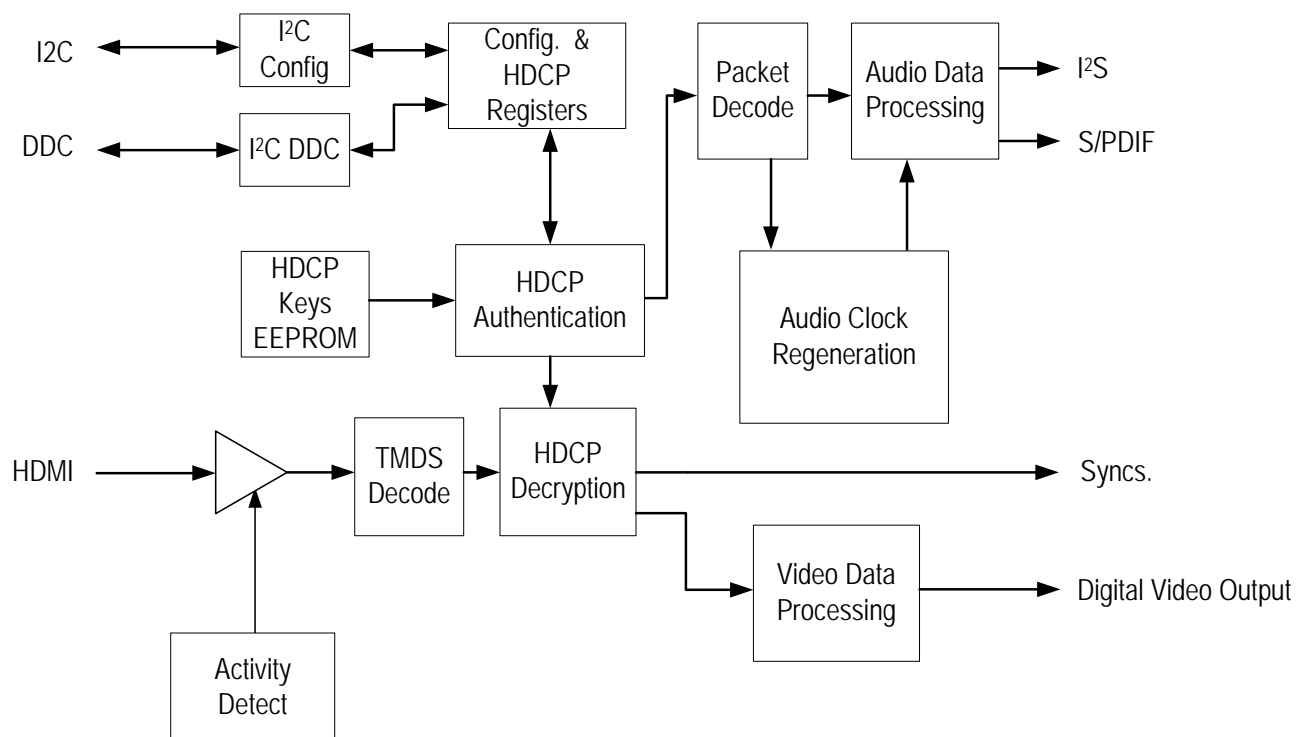

Overview

The ANX9011 is an advanced multimedia receiver compliant with High Definition Multimedia Interface (HDMI) Specification 1.2. HDMI is the first transport standard to unify digital video, audio, and control data over low-cost cables. It connects digital television, flat panel displays and project systems digitally to multimedia sources: DVD players, high definition set-top boxes, digital video tape recorders, and personal computers. Digital transmission, in turn, delivers an uncompromising multimedia experience. HDMI also includes encryption for premium contents pursuant to the High-bandwidth Digital Content Protection (HDCP) standard. The ANX9011 embeds the HDCP keys and key selection vectors to reduce manufacturing complexity and system cost.

The ANX9011 receives an HDMI data stream and decodes the selected input into digital audio and video data outputs. The receiver incorporates Analogix' proprietary WideEye™ architecture, which has received considerable industry acclaim when introduced in Analogix' 6.25 Gbps Serdes products for telecom and datacom applications. Applying the same advanced techniques in the ANX9011 product enables display systems to achieve error-free HDMI reception over long, inexpensive cables up to 40 meters and assures the widest range of interoperability against uncertain qualities of cheap cables from low-cost suppliers as the standard matures. Cables lengths of 40m or greater can be supported with the appropriate setting of the internal SerDes equalizer.

The ANX9011 can receive and output up to eight digital audio channels at up to 192 kHz sampling rate, making it the leading component for integrated home theaters and high definition televisions. The device supports direct connections to a wide selection of audio DACs and decoders through industry-standard I²S or S/PDIF interfaces.

The ANX9011 receiver is offered in 128-lead LQFP and 144-lead TQFP lead-free packages. For applications that require two HDMI inputs, designers should consider the ANX9021 product.

Related Products

Product Part Number	Description
ANX9011-EV	Single-channel HDMI receiver evaluation kit
ANX9011L	Single-channel HDMI receiver (128-pin LQFP package)
ANX9011T	Single-channel HDMI receiver (144-pin TQFP package)
ANX9012	Dual-channel HDMI receiver (144-pin TQFP package)
ANX90199-IP	HDMI receiver IP license
ANX9301	HDMI Transmitter (80 pin TQFP package)