

BS-115C MINIATURE RELAY

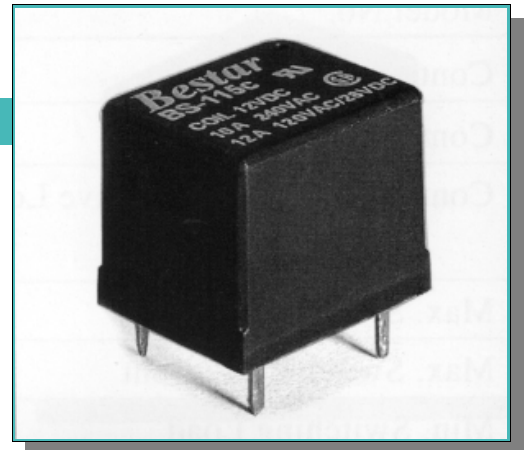

Features

- Ultra-miniature size (18.8 *15.4 *15.1 mm)
- High Switching Capacity up to 12A
- UL File No. E147052
- CSA File No. LR76479-1
- TUV File No. R9754066



Coil Rating (at 20°C)

Nominal Voltage (VDC)	Coil Resistance ($\Omega \pm 10\%$)	Nominal Current (mA)	Pick-Up Voltage (VDC)	Drop-Out Voltage (VDC)	Nominal Power (mW) Consumption
3	25	120	2.25	0.3	360
5	70	72	3.75	0.5	
6	100	60	4.50	0.6	
9	220	40	6.75	0.9	
12	400	30	9.00	1.2	
24	1600	15	18.00	2.4	
48	6400	7.5	36.00	4.8	

Ordering Information

- **BS - 115C S-A-12A-12VDC**

Protection	Contact Arrangement.	Contact Rating	Coil Voltage
Nil: Flux Free S: Sealed	Nil: 1 From C A: 1 From A	7A 12A	See Coil Rating

Specifications

Model No.	BS-115C-7A	BS-115C-12A
Contact Arrangement	1 From A, 1 From C	
Contact Material	AgCdO	
Contact Rating (at Resistive Load)	7A 120VAC 5A 240VAC/28VDC	12A 120VAC 10A 240VAC/28VDC
Max. Switching Voltage	240VAC, 60VDC	
Max. Switching Current	7A	12A
Min. Switching Load	100mA 5VD	
Contact Resistance	Max. 100mΩ (initial)	
Insulation Resistance	Min. 100MΩ at 500VDC	
Dielectric Strength Between Contacts Between Coil & Contact	750VAC 50 HZ / 60 HZ (1 minute) 1500VAC 50 HZ / 60 HZ (1 minute)	
Surge Strength	2000V	
Operate Time	Max. 10mSec.	
Release Time	Max. 5mSec.	
Ambient Temperature	-30°C ~ +55°C	
Vibration Resistance (Endurance)	1.5mm D.A. 10-55HZ	
Shock Resistance	Min. Unerror10G	
Mechanical Life	5,000,000 Operations (no load)	
Electrical Life	100,000 Operations (no load)	
Weight	Approx. 8g	

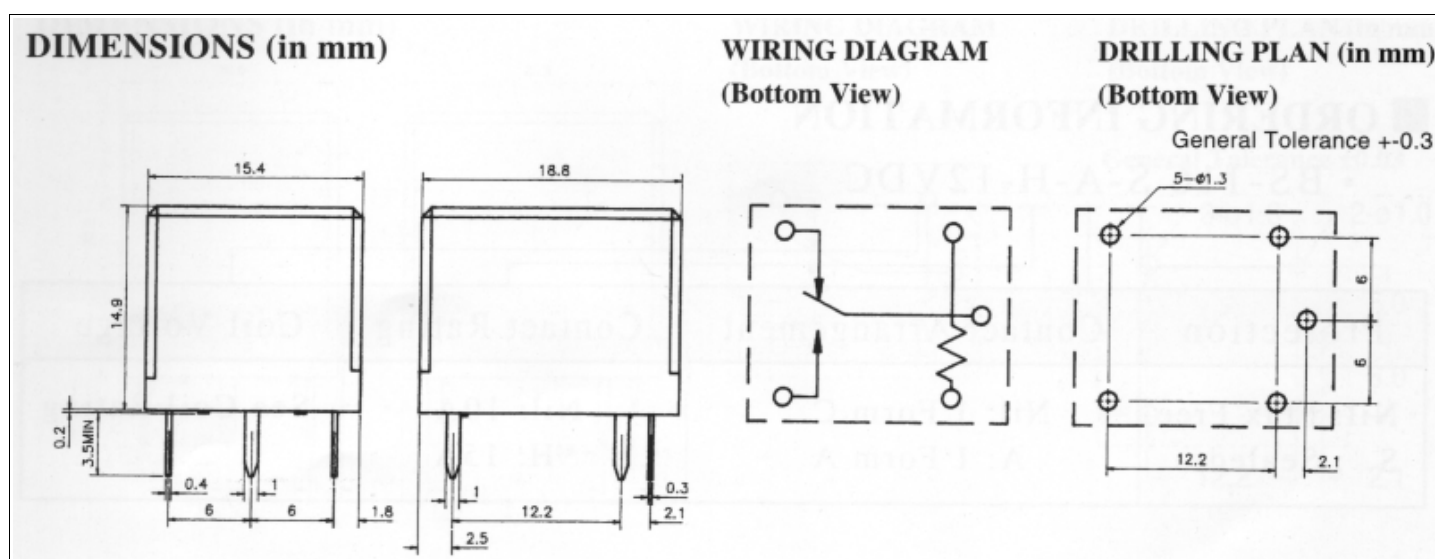

Relay Terminology: Coil

- **Nominal Voltage:** A single Value of source voltage design to be applied to the coil.
- **Pick Up Voltage:** As the voltage on an unoperated relay is increased, the value at or below which all contacts must function.
- **Drop Out Voltage:** As the voltage on an operated relay is decreased, the value at or above which all contacts must revert to their unoperated position.
- **Coil Resistance:** This is the DC resistance of the coil in DC type relays for the temperature conditions listed.
- **Nominal Current:** The value of current flow in the coil when nominal voltage is impressed on the coil.
- **Nominal Power Consumption:** The value of power used by the coil at nominal voltage or DC coils expressed in watts; AC expressed as Volt Amperes. (W or $VA = \text{Nominal Voltage} * \text{Nominal Current}$)

Relay Terminology: Contacts

- **Contact Arrangement;** Denotes the contact mechanism and number of contacts in the contact circuit.
- **Contact Resistance:** This value is the resistance when the contacts are touching each other and the resistance of the terminals and contact spring.
- **Rated Switching Current:** The designed value in watts (DC) or Volt Amperes (AC) which can safely be switched by the contacts.
- **Maximum Switching Current:** The maximum current which can safely be swithced by the contacts.
- **Maximum Switching Voltage:** The maximum open circuit voltage which can safely be switched by the contacts.
- **Minimum Switching Load:** The minimum value ofthe voltage and current which can be reliably switched by the contacts.

Relay Terminology: Performance

- **Insulation Resistance:** The resistance value between all mutually isolated conducting sections of all relay, i.e. between coil and contacts, across open contacts and between coil or contacts to any core or frame at ground potential.
- **Dielectric Strength:** The maximum voltage which can be tolerated by the relay without damage for a specified period of time, usually measured at the same points as insulation resistance. Usually the stated value is in VAC (RMS) for one minute duration.
- **Surge Strength:** The ability of the device to withstand an abnormal externally produced power surge, as in a lightning strike, or other phenomenon. An impulse test waveform is usually specified, including rise time, peak value and fall time.
- **Insulation Resistance:** The resistance ofthe insulated part between the contact and coil terminal or the insulated part among several contact terminals, etc.

www.DataSheet4U.com

- **Operate Time:** The elapsed time from the initial application of power to the coil, until the closure of the normally open contacts. (With multiple pole devices the time until the last contact closes.)
- **Release Time:** The elapsed time from the initial removal of coil power until the reclosure of the normally closed contacts (last contact with multi pole) this time does not include ceased.
- **Ambient Temperature:** The range of ambient temperature in which the relay can be used without damages in its characteristics or functions.
- **Vibration Resistance:** The resistance to the vibration applicable to the relay, expressed as a displacement and frequency range.
- **Shock Resistance:** The resistance to the shock applicable to the relay, expressed as an acceleration in G.
- **Mechanical Life:** The minimum number of times the relay can be operated under nominal condition (coil voltage, temperature, humidity, etc.) with no load on the contacts.
- **Electrical Life:** The minimum number of times the relay can be operated under nominal condition with a specific load being switched by the contacts.
- **Structure of Relays:** Relays are classified in 4 different types by the structure of terminals, cover and case, and mounting method of the relay.

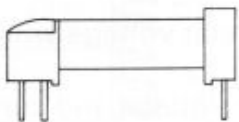
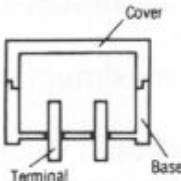
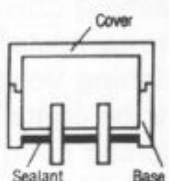
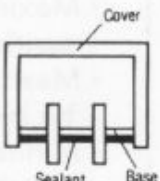
Item	Open Type	Dust cover Type	Flux Free Type	Sealed Type
Structure				
Characteristics	Terminals are molded or sealed simultaneous. No enclosure been provided.	Most basic construction and there is gap between cover and base, and between base and terminals.	Terminals are sealed with base by sealant. The joint level between cover and base is higher than the PC board surface.	All the gaps between case and base, base and terminals are sealed by sealant.
Mounting Method	Insertion mounting	Insertion mounting	Insertion mounting	Insertion mounting
Automatic Flux Coating	No	No	Yes	Yes
Automatic Soldering	No	No	Yes	Yes
Automatic Washing	No	No	No	Yes
Manual Soldering	Yes	Yes	Yes	Yes

Relay Soldering and Washing Guidelines

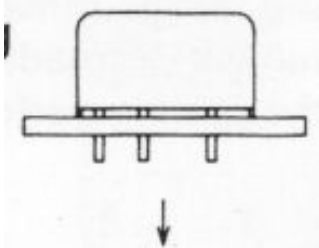
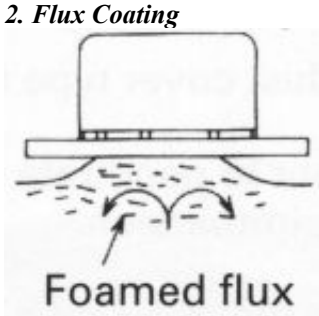
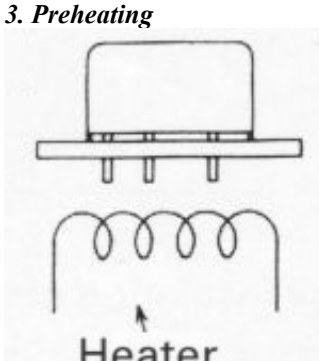
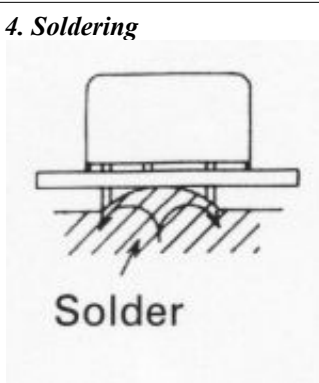
Process	Guidelines												
<p>1. Mounting of Relay</p> 	<ul style="list-style-type: none"> Avoid bending the terminals to make the relay self-clinching. Relay performance cannot be guaranteed if the terminals are bent. 												
<p>2. Flux Coating</p> 	<ul style="list-style-type: none"> Adjust the position of the PC board so that flux does not overflow onto the top of it. Use rosin-based flux, which is non-corrosive and requires no washing. Do not use Automatic Flux Coating Method to dust-coverttype relays. Do not overflow onto the top of PC Board, in such a case the flux may even penetrate a flux-resistant type relay. 												
<p>3. Preheating</p> 	<ul style="list-style-type: none"> Be sure to preheat before soldering. Preheating acts to improve solderability. Preheat according to the following conditions. <table border="1" data-bbox="686 1120 1228 1232"> <tr> <td>Temperature</td> <td>100°C / 212°F or less</td> </tr> <tr> <td>Time</td> <td>Within approx. 1 minute</td> </tr> </table> <ul style="list-style-type: none"> Note that long exposure to high temperatures (e.g. due to a malfunctioning unit) may affect relay characteristics. 	Temperature	100°C / 212°F or less	Time	Within approx. 1 minute								
Temperature	100°C / 212°F or less												
Time	Within approx. 1 minute												
<p>4. Soldering</p> 	<p>Automatic Soldering</p> <ul style="list-style-type: none"> Flow solder is the optimum method for soldering. Adjust the level of solder so that it does not overflow onto the top of the PC board. Unless otherwise specified, solder under the following conditions depending on the type of relay. <table border="1" data-bbox="686 1545 1228 1702"> <tr> <td>Solder Temperature</td> <td>Approx. 250°C / 482°F</td> </tr> <tr> <td>Soldering Time</td> <td>Within approx. 5 seconds</td> </tr> <tr> <td>Solder Ratio</td> <td>Sn/Pb = 60/40 or 63/37</td> </tr> </table> <p>Hand Soldering</p> <ul style="list-style-type: none"> Keep the tip of the soldering iron clean. <table border="1" data-bbox="686 1814 1228 1993"> <tr> <td>Solder Iron</td> <td>30W to 60W</td> </tr> <tr> <td>Iron Tip Temperature</td> <td>Approx. 300°C / 573°F</td> </tr> <tr> <td>Solder Time</td> <td>Within approx. 3 seconds</td> </tr> </table>	Solder Temperature	Approx. 250°C / 482°F	Soldering Time	Within approx. 5 seconds	Solder Ratio	Sn/Pb = 60/40 or 63/37	Solder Iron	30W to 60W	Iron Tip Temperature	Approx. 300°C / 573°F	Solder Time	Within approx. 3 seconds
Solder Temperature	Approx. 250°C / 482°F												
Soldering Time	Within approx. 5 seconds												
Solder Ratio	Sn/Pb = 60/40 or 63/37												
Solder Iron	30W to 60W												
Iron Tip Temperature	Approx. 300°C / 573°F												
Solder Time	Within approx. 3 seconds												

Relay Soldering and Washing Guidelines

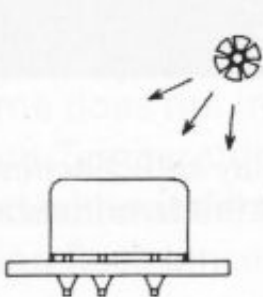
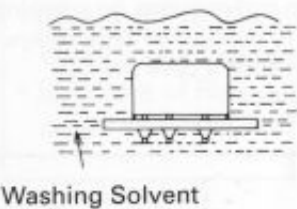
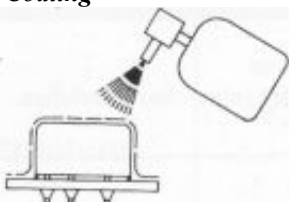
Process	Guidelines
<p>5. Cooling</p> 	<ul style="list-style-type: none"> • Immediate air cooling is recommended to prevent deterioration of the relay and surrounding parts due to soldering heat. • Although the sealed type relay can be cleaned, avoid immersing the relay into cold liquid (such as washing solvent) immediately after soldering. Doing so may deteriorate the sealing performance.
<p>6. Washing</p> 	<ul style="list-style-type: none"> • Do not wash flux-resistant type relays and dust cover type relays by immersion. • Careless washing may cause washing solvent to penetrate the relay. • Plastic sealed type relays can be washed by immersion. Use washing solvents shown in Table 6. • Use of other washing solvents may damage the relay case and cover, and also cause washing solvent to penetrate the relay, • Washing with the boiling methods is recommended. Avoid ultrasonic washing on relays. Use of ultra-sonic cleaning may cause breaks in the coil or slight sticking of contacts due to the ultrasonic energy.
<p>7. Coating</p> 	<ul style="list-style-type: none"> • If the PC board is to be coated to prevent the insulation of the PC board from deteriorating due to corrosive gases and high temperature, note the following. <ul style="list-style-type: none"> * Do not coat dust-cover type relays and flux-resistant type relays. * Depending on the type, some coating materials may have an adverse affect on relays, select coating materials carefully.