

Agilent

Subminiature High Performance AlInGaP LED Lamps

Data Sheet

SunPower Series

**HLMA-PF00, HLMA-PG00, HLMA-PH00, HLMA-PL00, HLMA-QF00,
HLMA-QG00, HLMA-QH00, HLMA-QL00, HLMT-PG00, HLMT-PH00,
HLMT-PL00, HLMT-QG00, HLMT-QH00, HLMT-QL00**

Description

Flat Top Package

The HLMX-PXXX flat top lamps use an untinted, nondiffused, truncated lens to provide a wide radiation pattern that is necessary for use in backlighting applications. The flat top lamps are also ideal for use as emitters in light pipe applications.

Dome Packages

The HLMX-QXXX dome lamps use an untinted, nondiffused lens to provide a high luminous intensity within a narrow radiation pattern.

Lead Configurations

All of these devices are made by encapsulating LED chips on axial lead frames to form molded epoxy subminiature lamp packages. A variety of package configuration options is available. These include special surface mount lead configurations, gull wing, yoke lead, or Z-bend. Right angle lead bends at

2.54 mm (0.100 inch) and 5.08 mm (0.200 inch) center spacing are available for through hole mounting. For more information refer to Standard SMT and Through Hole Lead Bend Options for Subminiature LED Lamps data sheet.

Technology

These subminiature solid state lamps utilize one of the two newly developed aluminum indium gallium phosphide (AlInGaP) LED technologies, either the absorbing substrate carrier technology (AS = HLMA-Devices) or the transparent substrate carrier technology (TS = HLMT-Devices). The TS HLMT-Devices are especially effective in very bright ambient lighting conditions. The colors 590 nm amber, 605 nm orange, 615 nm reddish-orange, 626 nm red, and 635 nm red are available with viewing angles of 15° for the domed devices and 125° for the flat top devices.

Features

- **Subminiature flat top package**
Ideal for backlighting and light piping applications
- **Subminiature dome package**
Nondiffused dome for high brightness
- **Wide range of drive currents**
- **Colors: 590 nm Amber, 605 nm Orange, 615 nm Reddish-Orange, 626 nm Red, and 635 nm Red**
- **Ideal for space limited applications**
- **Axial leads**
- **Available with lead configurations for surface mount and through hole PC board mounting**



Device Selection Guide

Part Number	λ_d (nm)	Typ. I_V (mcd)	Package Description	Viewing Angle $2\theta^{1/2}$	Package Outline
HLMA-QL00	590	500	Domed, Nondiffused, Untinted	15°	B
HLMT-QL00	590	1000			
HLMA-QJ00	605	500			
HLMA-QH00	615	500			
HLMT-QH00	615	800			
HLMA-QG00	626	500			
HLMT-QG00	626	1000			
HLMA-QF00	635	500			
HLMA-PL00	590	75	Flat Top, Nondiffused, Untinted	125°	A
HLMT-PL00	590	150			
HLMA-PJ00	605	75			
HLMA-PH00	615	75			
HLMT-PH00	615	120			
HLMA-PG00	626	75			
HLMT-PG00	626	150			
HLMA-PF00	635	75			

Part Numbering System

HLMx - x x 00 - x x x xx

Packaging Option

- 00: Straight Leads, Bulk Packaging, Quantity of 500 parts
- 11: Gull Wing Bend, Tape & Reel – 7" Reel
- 12: Gull Wing Bend, Bulk
- 14: Gull Wing Bend, Tape & Reel – 13" Reel
- 21: Yoke Bend, Tape and Reel – 7" Reel
- 22: Yoke Bend, Bulk
- 24: Yoke Bend, Tape and Reel – 13" Reel
- 31: Z-Bend, Tape and Reel – 7" Reel
- 32: Z-Bend, Bulk
- 34: Z-Bend, Tape and Reel – 13" Reel

Color Bin Selection

- 0: Full Color Bin Distribution
- B: Color Bins 3 & 4
- K: Color Bins 2, 3 & 4
- R: Color Bins 2 & 4
- W: Color Bins 2, 4, 6 & 7
- X: Color Bins 4, 6 & 7

Maximum Iv Bin Options

Please refer to the Iv Bin Table

Minimum Iv Bin Options

Please refer to the Iv Bin Table

Color Options

- L: Amber 590 nm
- J: Orange 605 nm
- H: Reddish Orange 615 nm
- G: Red 626 nm
- F: Red 635 nm

Package Options

- Q: Dome
- P: Flat Top

Dice Options

- A: AS AlInGaP
- T: TS AlInGaP

Package Dimensions

(A) Flat Top Lamps

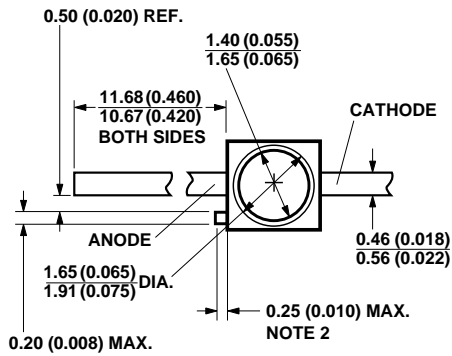

(B) Domed Lamps, Diffused and Nondiffused

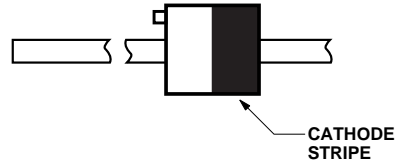
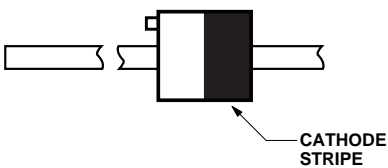
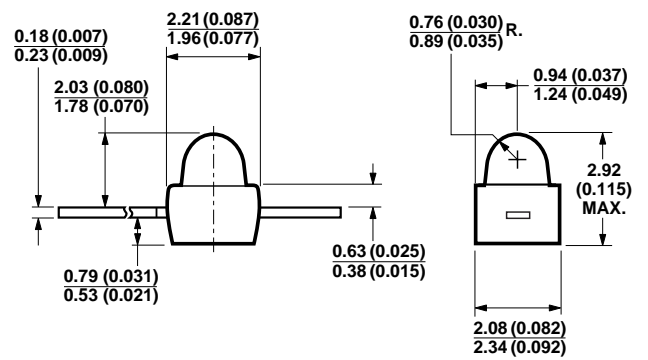
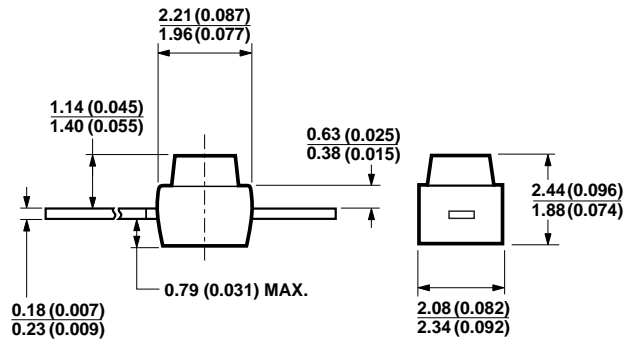
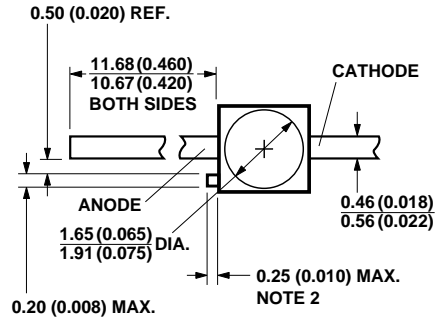

- NOTES:**
 1. ALL DIMENSIONS ARE IN MILLIMETRES (INCHES).
 2. PROTRUDING SUPPORT TAB IS CONNECTED TO CATHODE LEAD.

Absolute Maximum Ratings at $T_A = 25^\circ\text{C}$

Parameter	HLMA-xxxx	HLMT-xxxx	Unit
Peak Forward Current ^[2]	100	100	mA
Average Forward Current ($I_{PEAK} = 100\text{ mA}$) ^[1,2]	30	37	mA
DC Forward Current ^[3,5,6]	50	50	mA
Power Dissipation	105	120	mW
Reverse Voltage ($I_R = 100\ \mu\text{A}$)	5		V
Transient Forward Current (10 μs Pulse) ^[5]	500		mA
Operating Temperature Range	-40 to +100		$^\circ\text{C}$
Storage Temperature Range	-55 to +100		$^\circ\text{C}$
LED Junction Temperature	110		$^\circ\text{C}$
Lead Soldering Temperature [1.6 mm (0.063 in.) from body]	260 $^\circ\text{C}$ for 5 seconds		
SMT Reflow Soldering Temperature	260 $^\circ\text{C}$ for 20 seconds		

Notes:

1. Maximum I_{AVG} at $f = 1\text{ kHz}$.
2. Refer to Figure 5 to establish pulsed operating conditions.
3. Derate linearly as shown in Figure 4.
4. The transient peak current is the maximum non-recurring peak current these devices can withstand without damaging the LED die and wire bonds. Operation at currents above Absolute Maximum Peak Forward Current is not recommended.
5. Drive currents between 10 mA and 30 mA are recommended for best long term performance.
6. Operation at currents below 5 mA is not recommended, please contact your Agilent sales representative.

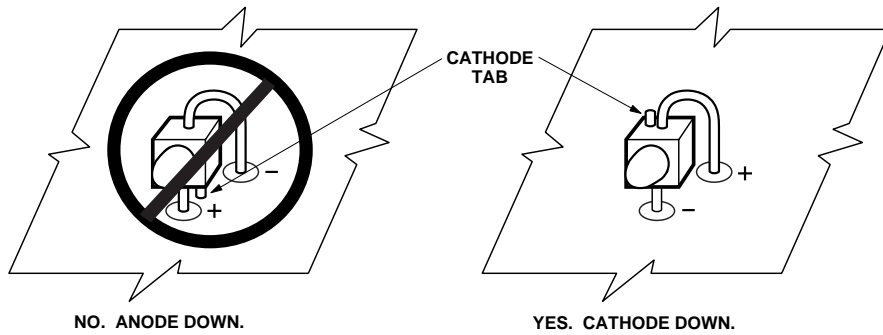

Proper right angle mounting to a PC board to prevent protruding cathode tab from shorting to anode connection.

Optical Characteristics at T_A = 25°C

Part Number	Luminous Intensity I _v (mcd) @ 20 mA ^[1]			Total Flux Φ _v (mlm) @ 20 mA ^[2]	Peak Wavelength λ _{peak} (nm)	Color, Dominant Wavelength λ _d ^[3] (nm)	Viewing Angle 2 θ _{1/2} Degrees ^[4]	Luminous Efficacy η _v ^[5] (lm/w)
	Min.	Typ.	Max.	Typ.	Typ.	Typ.	Typ.	Typ.
HLMA-QL00-S00xx	160	500	–	250	592	590	15	480
HLMA-QL00-TU0xx	250	–	800	250	592	590	15	480
HLMA-QL00-TUKxx	250	–	800	250	592	590	15	480
HLMA-QL00-TVBxx	250	–	1250	250	592	590	15	480
HLMA-QL00-TVKxx	250	–	1250	250	592	590	15	480
HLMA-QL00-UV0xx	400	–	1250	250	592	590	15	480
HLMA-QL00-UVRxx	400	–	1250	250	592	590	15	480
HLMA-QL00-UWBxx	400	–	2000	250	592	590	15	480
HLMT-QL00-T00xx	250	1000	–	800	592	590	15	480
HLMA-QJ00-S00xx	160	500	–	250	609	605	15	370
HLMA-QH00-S00xx	160	500	–	250	621	615	15	263
HLMA-QH00-T00xx	250	500	–	250	621	615	15	263
HLMA-QH00-UW0xx	400	–	2000	250	621	615	15	263
HLMT-QH00-T00xx	250	500	–	800	621	615	15	263
HLMT-QH00-WX0xx	1000	–	3200	800	621	615	15	263
HLMA-QG00-S00xx	160	500	–	250	635	626	15	150
HLMA-QG00-TV0xx	250	–	1250	250	635	626	15	150
HLMT-QG00-T00xx	250	1000	–	800	635	626	15	150
HLMA-QF00-S00xx	160	500	–	250	650	635	15	110
HLMA-PL00-N00xx	25	75	–	250	592	590	125	480
HLMA-PL00-PRRxx	40	–	200	250	592	590	125	480
HLMA-PL00-PRXxx	40	–	200	250	592	590	125	480
HLMA-PL00-QRXxx	63	–	200	250	592	590	125	480
HLMT-PL00-P0Wxx	40	150	–	800	592	590	125	480
HLMA-PJ00-N00xx	25	75	–	250	609	605	125	370
HLMA-PH00-N00xx	25	75	–	250	621	615	125	263
HLMT-PH00-P00xx	40	120	–	800	621	615	125	263
HLMA-PG00-N00xx	25	75	–	250	635	626	125	150
HLMT-PG00-P00xx	40	150	–	800	635	626	125	150
HLMA-PF00-N00xx	25	75	–	250	640	635	125	110

Notes:

1. The luminous intensity, I_v, is measured at the mechanical axis of the lamp package. The actual peak of the spatial radiation pattern may not be aligned with this axis.
2. Φ_v is the total luminous flux output as measured with an integrating sphere.
3. The dominant wavelength, λ_d, is derived from the CIE Chromaticity Diagram and represents the color of the device.
4. θ_{1/2} is the off-axis angle where the luminous intensity is 1/2 the peak intensity.
5. Radiant intensity, I_e, in watts/steradian, may be calculated from the equation I_e = I_v/η_v, where I_v is the luminous intensity in candelas and η_v is the luminous efficacy in lumens/watt.

Electrical Characteristics at $T_A = 25^\circ\text{C}$

Part Number	Forward Voltage V_F (Volts) @ $I_F = 20\text{ mA}$		Reverse Breakdown Voltage V_R (Volts) @ $I_R = 100\ \mu\text{A}$		Capacitance C (pF) $V_F = 0, f = 1\text{ MHz}$	Thermal Resistance $R_{\theta J-PIN}$ ($^\circ\text{C/W}$)	Speed of Response τ_s (ns) Time Constant e^{-t/τ_s}
	Typ.	Max.	Min.	Typ.	Typ.	Typ.	Typ.
HLMA-Qx00	1.9	2.4	5	25	40	170	13
HLMT-Qx00	2.0	2.4	5	20	70	170	13
HLMA-Px00	1.9	2.4	5	25	40	170	13
HLMT-Px00	2.0	2.4	5	20	70	170	13

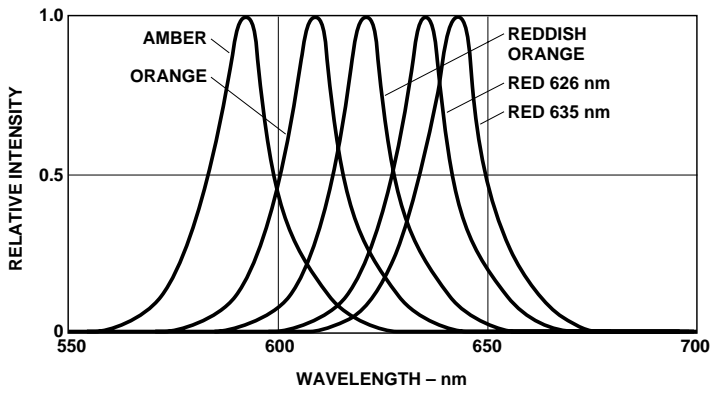

Figure 1. Relative intensity vs. wavelength.

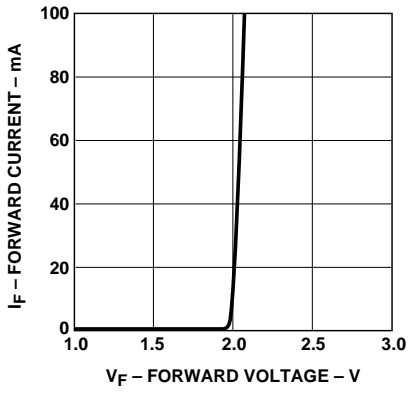

Figure 2a. Forward current vs. forward voltage. HLMA-xxxx.

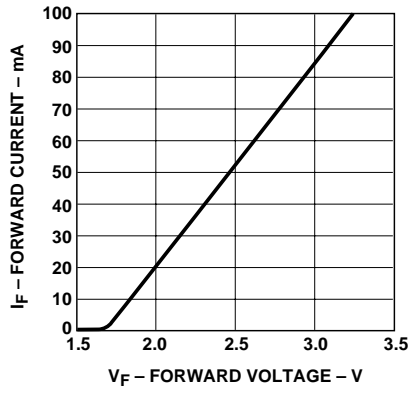

Figure 2b. Forward current vs. forward voltage. HLMT-xxxx.

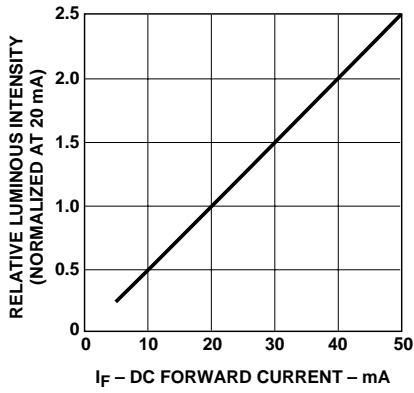

Figure 3a. Relative luminous intensity vs. DC forward current. HLMA-xxxx.

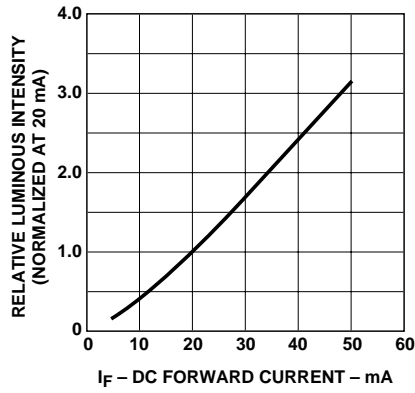

Figure 3b. Relative luminous intensity vs. DC forward current. HLMT-xxxx.

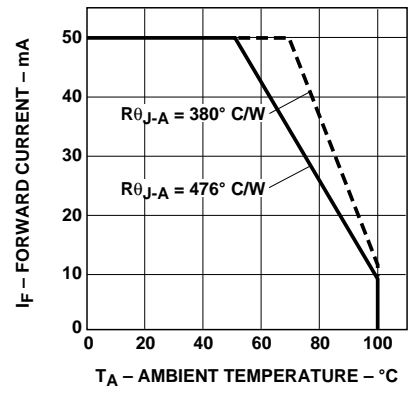

Figure 4. Maximum forward current vs. ambient temperature.

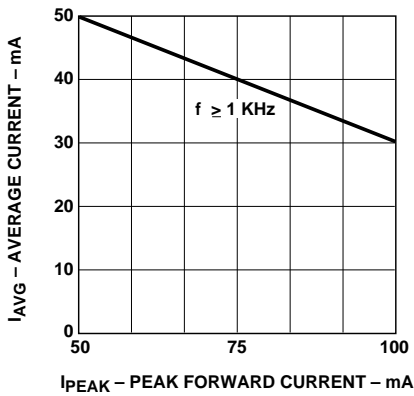

Figure 5a. Maximum average current vs. peak forward current for HLMA-xxxx.

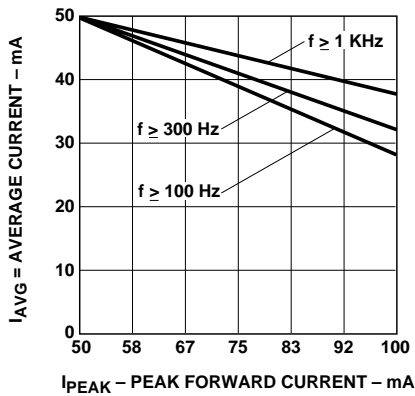

Figure 5b. Maximum average current vs. peak forward current for HLMT-xxxx.

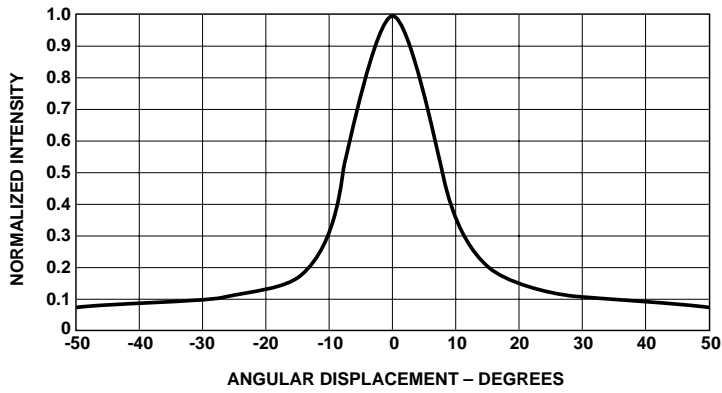

Figure 6. Relative luminous intensity vs. angular displacement for 15° device.

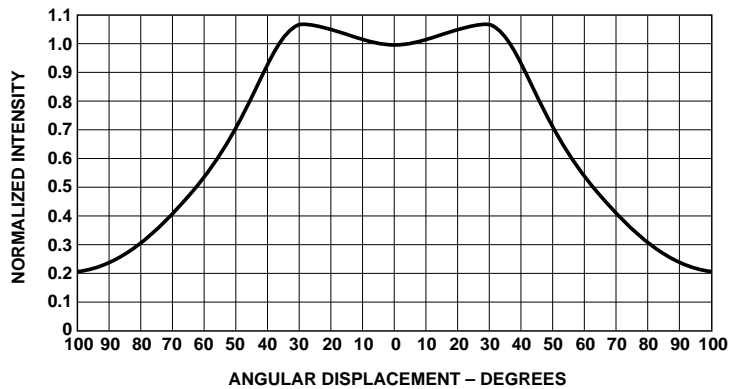

Figure 7. Relative luminous intensity vs. angular displacement for 125° device.

Intensity Bin Limits

Bin	Min.	Max.
N	25	50
P	40	80
Q	63	125
R	100	200
S	160	320
T	250	500
U	400	800
V	630	1250
W	1000	2000
X	1600	3200
Y	2500	5000

Color Bin Limits

Package	Bin	Min.	Max.
Yellow	0	Full Distribution	
	3	584.0	587.5
	2	586.5	590.0
	4	589.0	592.5
	6	591.5	595.0
	7	594.0	597.5
	Orange	0	Full Distribution
2		599.0	602.5
3		601.5	604.0
4		603.8	608.2
5		606.8	611.2

Mechanical Option Matrix

Mechanical Option Code	Definition
00	Straight Leads, Bulk Packaging, Quantity of 500 Parts
11	Gull Wing Leads, 12 mm Tape on 7 in. Dia. Reel, 1500 Parts per Reel
12	Gull Wing Leads, Bulk Packaging, Quantity of 500 Parts
14	Gull Wing Leads, 12 mm Tape on 13 in. Dia. Reel, 6000 Parts per Reel
21	Yoke Leads, 12 mm Tape on 7 in. Dia. Reel, 1500 Parts per Reel
22	Yoke Leads, Bulk Packaging, Quantity of 500 Parts
24	Yoke Leads, 12 mm Tape on 13 in. Dia. Reel, 6000 Parts per Reel
31	Z-Bend Leads, 12 mm Tape on 7 in. Dia. Reel, 1500 Parts per Reel
32	Z-Bend Leads, Bulk Packaging, Quantity of 500 Parts
34	Z-Bend Leads, 12 mm Tape on 13 in. Dia. Reel, 6000 Parts per Reel

Note:

All categories are established for classification of products. Products may not be available in all categories. Please contact your local Agilent representative for further clarification/information.

www.agilent.com/semiconductors

For product information and a complete list of distributors, please go to our web site.

For technical assistance call:

Americas/Canada: +1 (800) 235-0312 or
(916) 788-6763

Europe: +49 (0) 6441 92460

China: 10800 650 0017

Hong Kong: (+65) 6756 2394

India, Australia, New Zealand: (+65) 6755 1939

Japan: (+81 3) 3335-8152(Domestic/International), or 0120-61-1280(Domestic Only)

Korea: (+65) 6755 1989

Singapore, Malaysia, Vietnam, Thailand,
Philippines, Indonesia: (+65) 6755 2044

Taiwan: (+65) 6755 1843

Data subject to change.

Copyright © 2004 Agilent Technologies, Inc.

Obsoletes 5989-0660EN

November 2, 2004

5989-1709 EN



Agilent Technologies