

GenX3™ 600V IGBTs

IXGK120N60B3 IXGX120N60B3

Medium-Speed-Low-Vsat PT IGBTs for 5-40kHz Switching

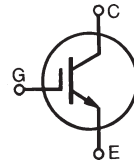

$V_{CES} = 600V$
 $I_{C110} = 120A$
 $V_{CE(sat)} \leq 1.8V$
 $t_{fi(typ)} = 145ns$

Symbol	Test Conditions	Maximum Ratings	
V_{CES}	$T_J = 25^\circ C$ to $150^\circ C$	600	V
V_{CGR}	$T_J = 25^\circ C$ to $150^\circ C$, $R_{GE} = 1M\Omega$	600	V
V_{GES}	Continuous	± 20	V
V_{GEM}	Transient	± 30	V
I_{C25}	$T_C = 25^\circ C$ (Chip Capability)	280	A
I_{C110}	$T_C = 110^\circ C$	120	A
I_{LRMS}	Terminal Current Limit	160	A
I_{CM}	$T_C = 25^\circ C$, 1ms	600	A
SSOA (RBSOA)	$V_{GE} = 15V$, $T_{VJ} = 125^\circ C$, $R_G = 2\Omega$ Clamped Inductive Load	$I_{CM} = 300$ $V_{CE} \leq V_{CES}$	A
P_C	$T_C = 25^\circ C$	780	W
T_J		-55 ... +150	$^\circ C$
T_{JM}		150	$^\circ C$
T_{stg}		-55 ... +150	$^\circ C$
T_L	Maximum Lead Temperature for Soldering	300	$^\circ C$
T_{SOLD}	1.6 mm (0.062 in.) from Case for 10	260	$^\circ C$
M_d	Mounting Torque (IXGK)	1.13/10	Nm/lb.in.
F_c	Mounting Force (IXGX)	20..120/4.5..27	N/lb.
Weight	TO-264	10	g
	PLUS247	6	g

TO-264 (IXGK)

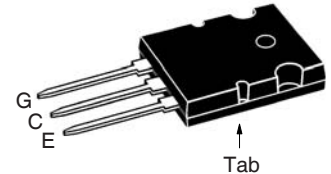

PLUS247™ (IXGX)

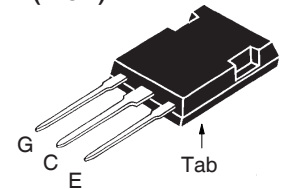

G = Gate E = Emitter
 C = Collector Tab = Collector

Features

- Optimized for Low Conduction and Switching Losses
- Square RBSOA
- High Current Handling Capability
- International Standard Packages

Advantages

- High Power Density
- Low Gate Drive Requirement

Applications

- Power Inverters
- UPS
- Motor Drives
- SMPS
- PFC Circuits
- Battery Chargers
- Welding Machines
- Lamp Ballasts

Symbol	Test Conditions ($T_J = 25^\circ C$, Unless Otherwise Specified)	Characteristic Values		
		Min.	Typ.	Max.
BV_{CES}	$I_C = 250\mu A$, $V_{GE} = 0V$	600		V
$V_{GE(th)}$	$I_C = 500\mu A$, $V_{CE} = V_{GE}$	3.0		5.0 V
I_{CES}	$V_{CE} = V_{CES}$, $V_{GE} = 0V$ $T_J = 125^\circ C$			50 μA 3 mA
I_{GES}	$V_{CE} = 0V$, $V_{GE} = \pm 20V$			± 100 nA
$V_{CE(sat)}$	$I_C = 100A$, $V_{GE} = 15V$, Note 1		1.5	1.8 V

Symbol	Test Conditions ($T_J = 25^\circ\text{C}$, Unless Otherwise Specified)	Characteristic Values		
		Min.	Typ.	Max.
g_{fs}	$I_C = 60\text{A}$, $V_{CE} = 10\text{V}$, Note 1	100	170	S
C_{ies} C_{oes} C_{res}	$V_{CE} = 25\text{V}$, $V_{GE} = 0\text{V}$, $f = 1\text{MHz}$		14.6	nF
			790	pF
			140	pF
Q_g Q_{ge} Q_{gc}	$I_C = 120\text{A}$, $V_{GE} = 15\text{V}$, $V_{CE} = 0.5 \cdot V_{CES}$		465	nC
			74	nC
			167	nC
$t_{d(on)}$ t_{ri} E_{on} $t_{d(off)}$ t_{fi} E_{off}	Inductive load, $T_J = 25^\circ\text{C}$ $I_C = 100\text{A}$, $V_{GE} = 15\text{V}$ $V_{CE} = 480\text{V}$, $R_G = 2\Omega$ Note 2		40	ns
			87	ns
			2.9	mJ
			227	ns
			145	ns
			3.5	mJ
$t_{d(on)}$ t_{ri} E_{on} $t_{d(off)}$ t_{fi} E_{off}	Inductive load, $T_J = 125^\circ\text{C}$ $I_C = 100\text{A}$, $V_{GE} = 15\text{V}$ $V_{CE} = 480\text{V}$, $R_G = 2\Omega$ Note 2		38	ns
			85	ns
			4.0	mJ
			290	ns
			230	ns
			4.7	mJ
R_{thJC} R_{thCS}		0.15	0.16°C/W $^\circ\text{C/W}$	

TO-264 AA (IXGK) Outline

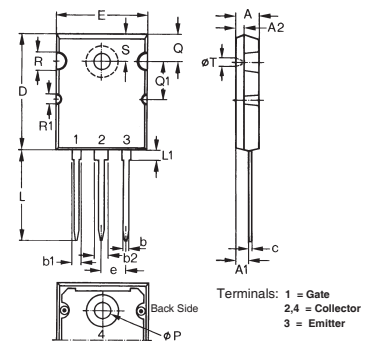

Dim.	Millimeter		Inches	
	Min.	Max.	Min.	Max.
A	4.82	5.13	.190	.202
A1	2.54	2.89	.100	.114
A2	2.00	2.10	.079	.083
b	1.12	1.42	.044	.056
b1	2.39	2.69	.094	.106
b2	2.90	3.09	.114	.122
c	0.53	0.83	.021	.033
D	25.91	26.16	1.020	1.030
E	19.81	19.96	.780	.786
e	5.46 BSC .215 BSC			
J	0.00	0.25	.000	.010
K	0.00	0.25	.000	.010
L	20.32	20.83	.800	.820
L1	2.29	2.59	.090	.102
P	3.17	3.66	.125	.144
Q	6.07	6.27	.239	.247
Q1	8.38	8.69	.330	.342
R	3.81	4.32	.150	.170
R1	1.78	2.29	.070	.090
S	6.04	6.30	.238	.248
T	1.57	1.83	.062	.072

Notes:

1. Pulse test, $t \leq 300\mu\text{s}$, duty cycle, $d \leq 2\%$.
2. Switching times & energy losses may increase for higher $V_{CE}(\text{Clamp})$, T_J or R_G .

PLUS247™ (IXGX) Outline

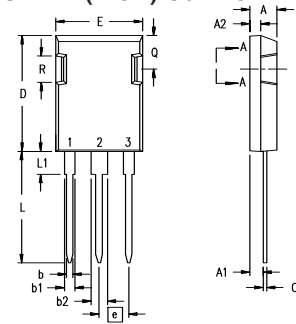

Terminals: 1 - Gate
2 - Collector
3 - Emitter

Dim.	Millimeter		Inches	
	Min.	Max.	Min.	Max.
A	4.83	5.21	.190	.205
A ₁	2.29	2.54	.090	.100
A ₂	1.91	2.16	.075	.085
b	1.14	1.40	.045	.055
b ₁	1.91	2.13	.075	.084
b ₂	2.92	3.12	.115	.123
C	0.61	0.80	.024	.031
D	20.80	21.34	.819	.840
E	15.75	16.13	.620	.635
e	5.45 BSC .215 BSC			
L	19.81	20.32	.780	.800
L1	3.81	4.32	.150	.170
Q	5.59	6.20	.220	0.244
R	4.32	4.83	.170	.190

IXYS Reserves the Right to Change Limits, Test Conditions, and Dimensions.

IXYS MOSFETs and IGBTs are covered by one or more of the following U.S. patents:	4,835,592	4,931,844	5,049,961	5,237,481	6,162,665	6,404,065 B1	6,683,344	6,727,585	7,005,734 B2	7,157,338B2
	4,850,072	5,017,508	5,063,307	5,381,025	6,259,123 B1	6,534,343	6,710,405 B2	6,759,692	7,063,975 B2	
	4,881,106	5,034,796	5,187,117	5,486,715	6,306,728 B1	6,583,505	6,710,463	6,771,478 B2	7,071,537	

Fig. 1. Output Characteristics @ $T_J = 25^\circ\text{C}$

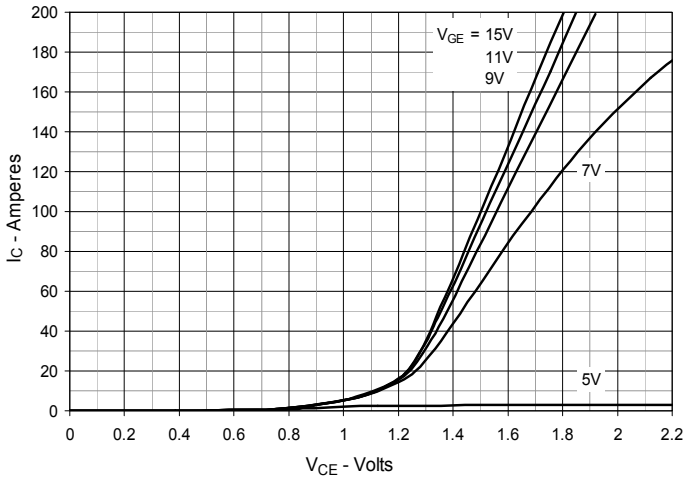

Fig. 2. Extended Output Characteristics @ $T_J = 25^\circ\text{C}$

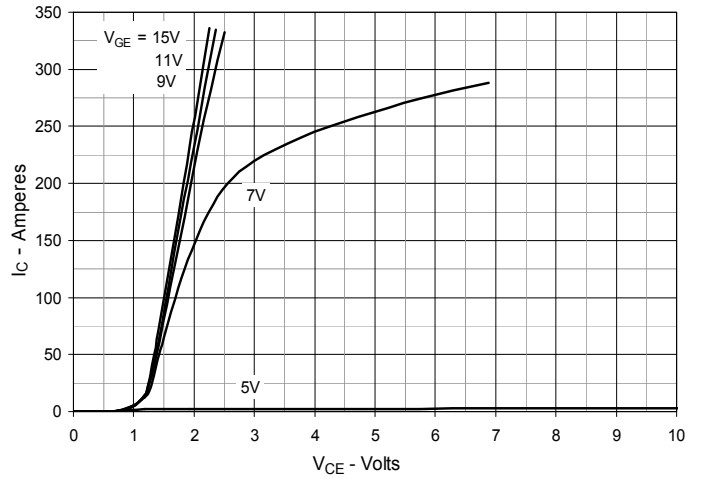

Fig. 3. Output Characteristics @ $T_J = 125^\circ\text{C}$

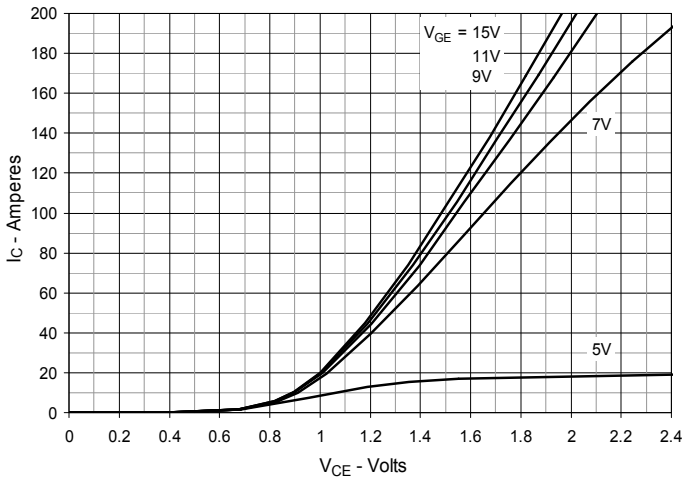

Fig. 4. Dependence of $V_{CE(sat)}$ on Junction Temperature

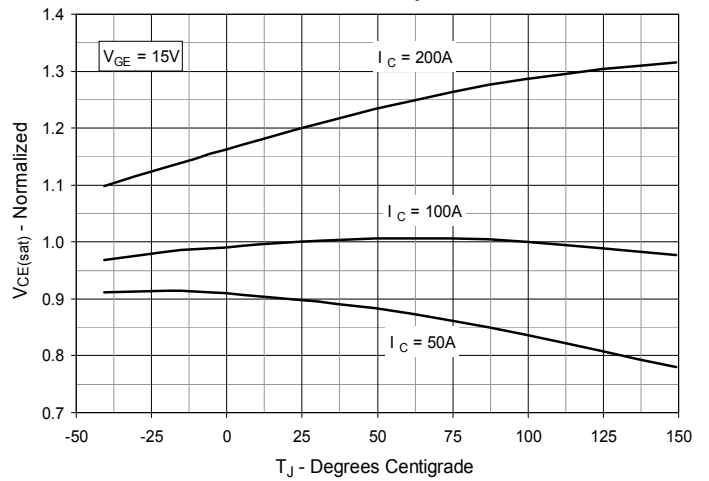

Fig. 5. Collector-to-Emitter Voltage vs. Gate-to-Emitter Voltage

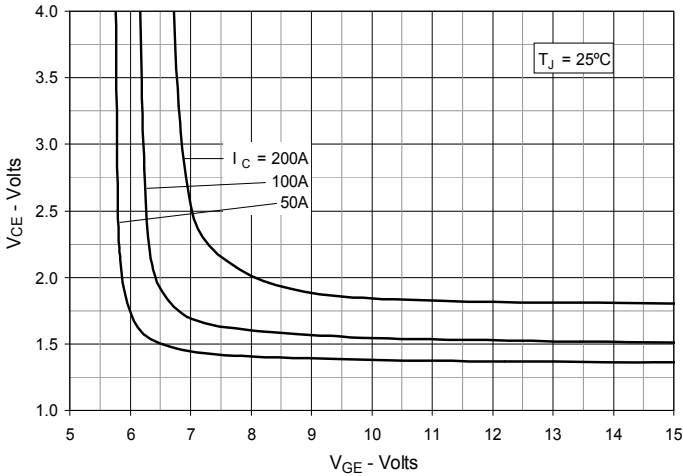

Fig. 6. Input Admittance

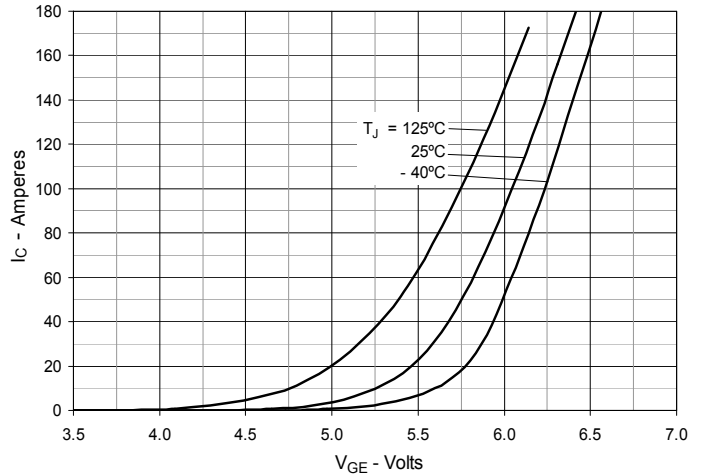

Fig. 7. Transconductance

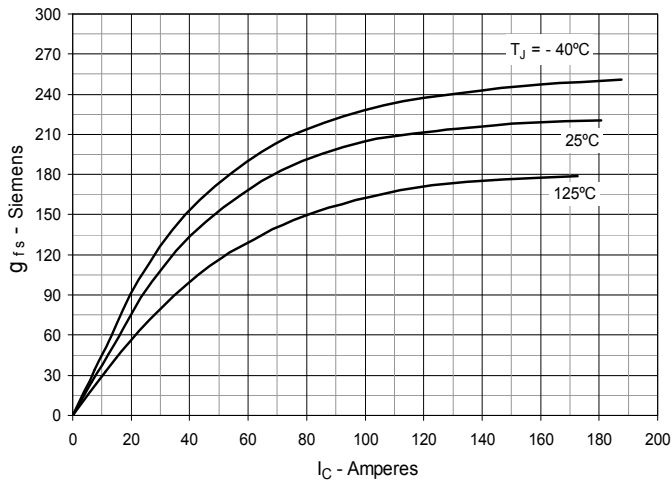

Fig. 8. Gate Charge

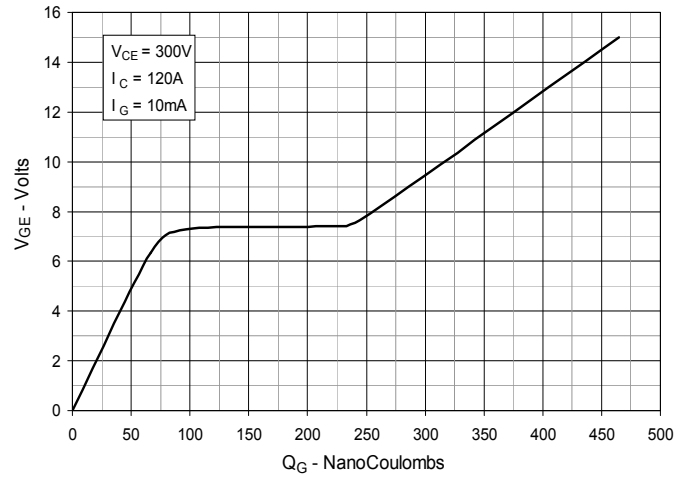

Fig. 9. Capacitance

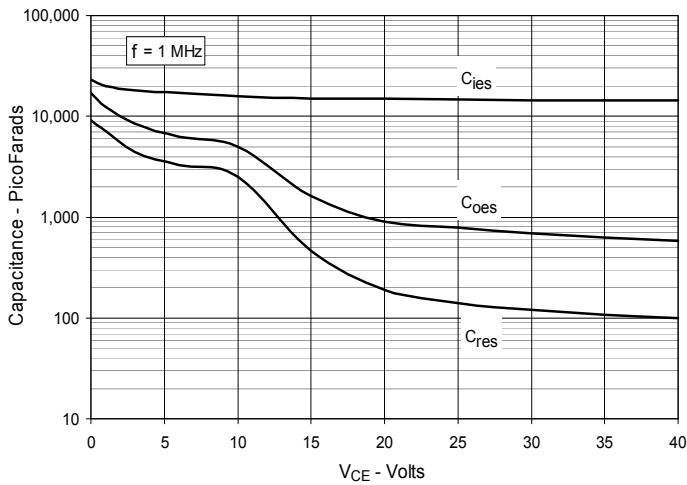

Fig. 10. Reverse-Bias Safe Operating Area

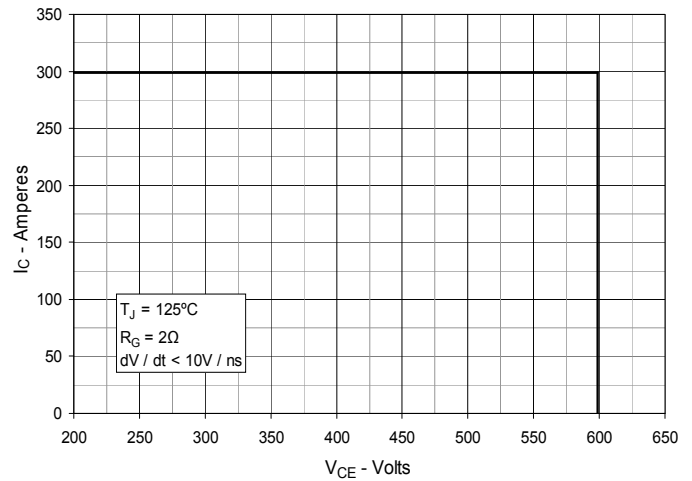

Fig. 11. Maximum Transient Thermal Impedance

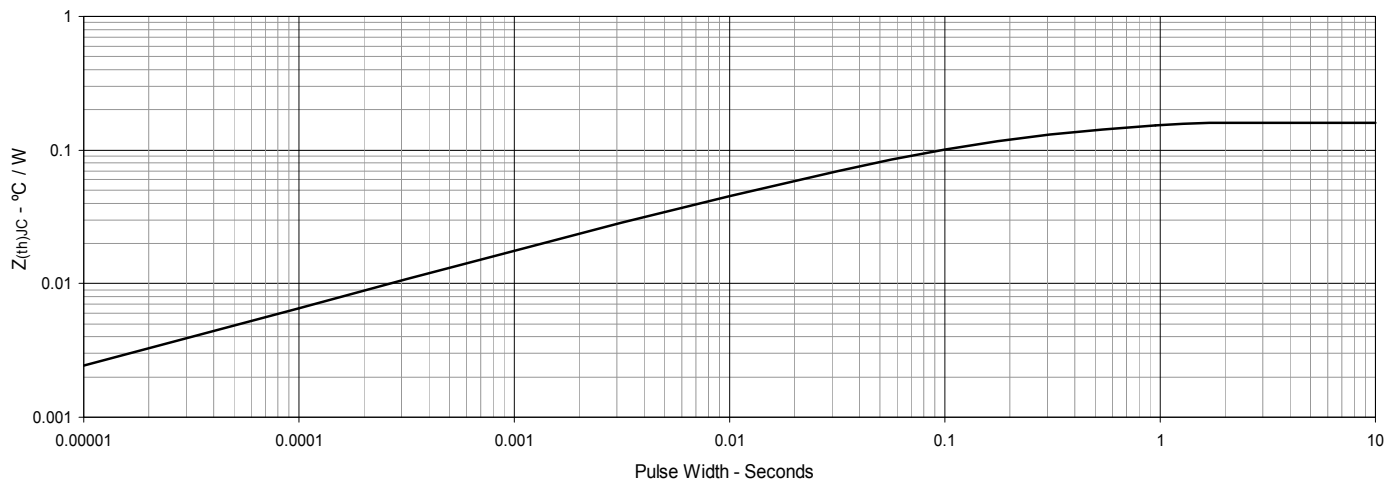

Fig. 12. Inductive Switching Energy Loss vs. Gate Resistance

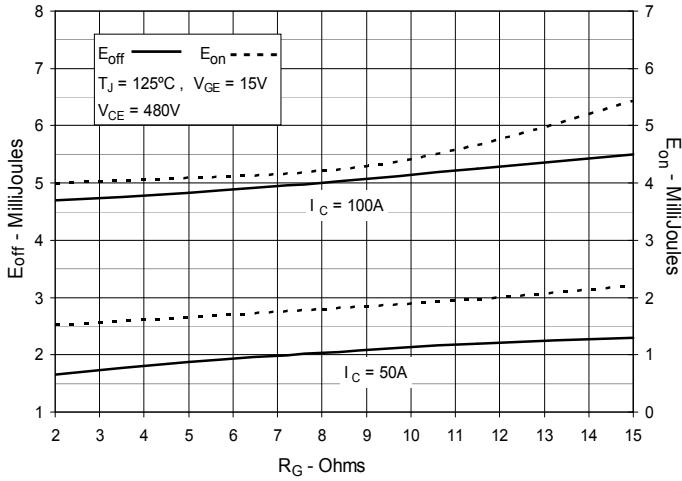

Fig. 13. Inductive Switching Energy Loss vs. Collector Current

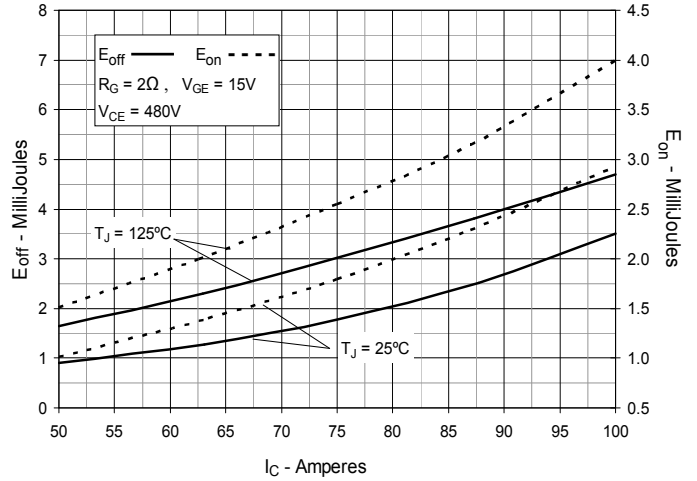

Fig. 14. Inductive Switching Energy Loss vs. Junction Temperature

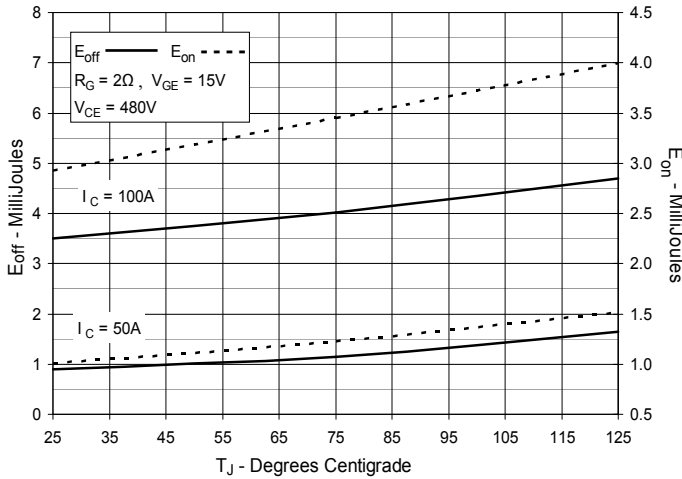

Fig. 15. Inductive Turn-off Switching Times vs. Gate Resistance

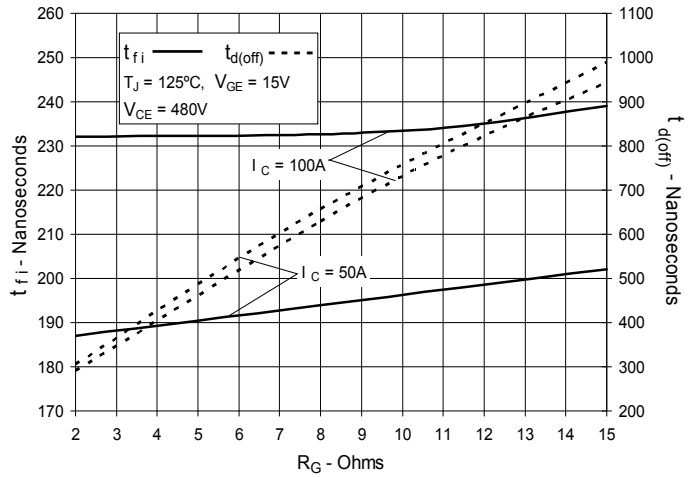

Fig. 16. Inductive Turn-off Switching Times vs. Collector Current

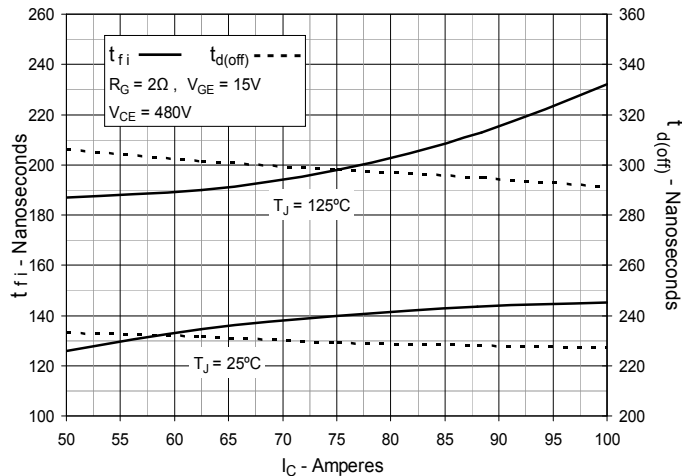

Fig. 17. Inductive Turn-off Switching Times vs. Junction Temperature

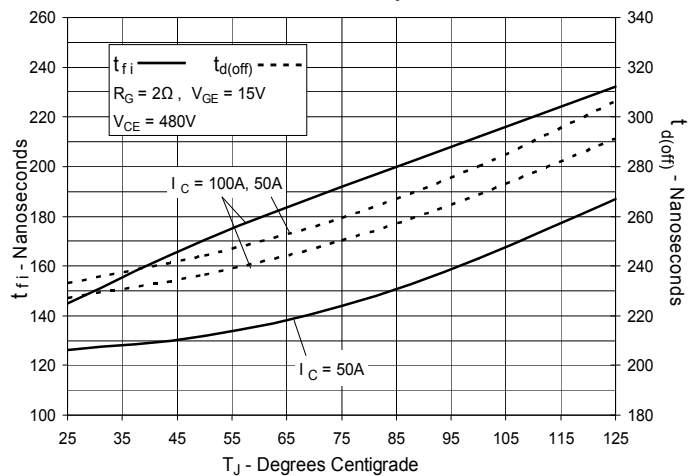

Fig. 18. Inductive Turn-on Switching Times vs. Gate Resistance

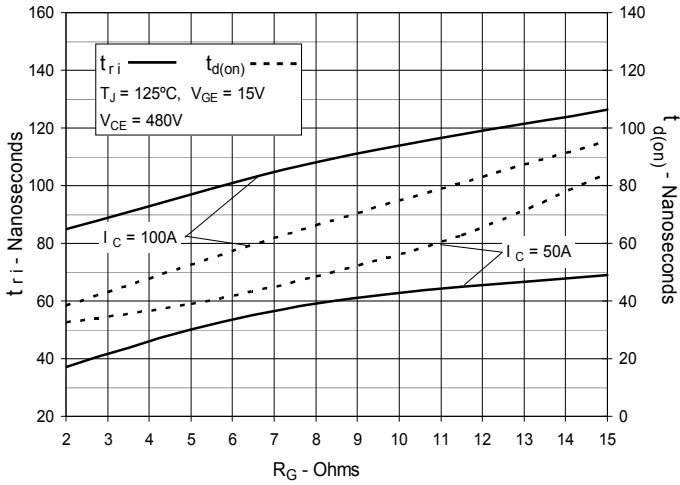

Fig. 19. Inductive Turn-on Switching Times vs. Collector Current

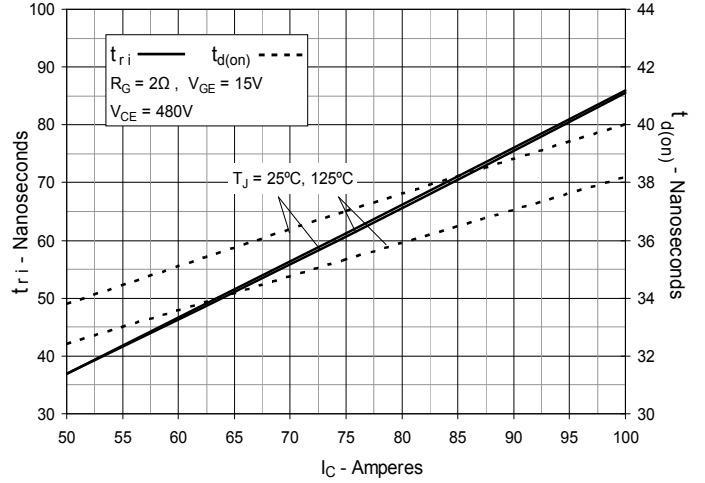

Fig. 20. Inductive Turn-on Switching Times vs. Junction Temperature

