

SGM2008

Low Power, Low Dropout, 300mA, RF - Linear Regulators

GENERAL DESCRIPTION

The SGM2008/A series low-power, low-noise, low-dropout, CMOS linear voltage regulators operate from a 2.5V to 5.5V input and deliver up to 300mA. They are the perfect choice for low voltage, low power applications. An ultra low ground current (200 μ A at 300mA output) makes these part attractive for battery operated power systems. The SGM2008/A series also offer ultra low dropout voltage (300mV at 300mA output) to prolong battery life in portable electronics. Systems requiring a quiet voltage source, such as RF applications, will benefit from the SGM2008/A series' ultra low output noise (30 μ VRMS) and high PSRR. An external noise bypass capacitor connected to the device's BP pin can further reduce the noise level.

The output voltage is preset to voltages in the range of 1.5V to 3.6V. Other features include a 10nA high logic-controlled shutdown mode, foldback current limit and thermal shut- down protection.

Devices come in 5-pin SOT23 package.

FEATURES

- Low Output Noise: 30 μ VRMS typ(10Hz to 100KHz)
- Ultra-Low Dropout Voltage:
300mV at 300mA output
- Low 77 μ A No-Load Supply Current
- Low 200 μ A Operating Supply Current
at 300mA Output
- High PSRR (73dB at 1KHz)
- Thermal-Overload Protection
- Output Current Limit
- 10nA high Logic-Controlled Shutdown
- Available in Multiple Output Voltage Versions
Fixed Outputs of 1.8V, 2.5V, 2.7V, 2.8V, 2.85V,
2.9V, 3.0V, 3.3V and 3.6V

APPLICATIONS

Cellular Telephones
Cordless Telephones
PHS Telephones
PCMCIA Cards
Modems
MP3 Player
Hand-Held Instruments
Palmtop Computers
Electronic Planners
Portable/Battery-Powered Equipment

PIN CONFIGURATIONS (TOP VIEW)

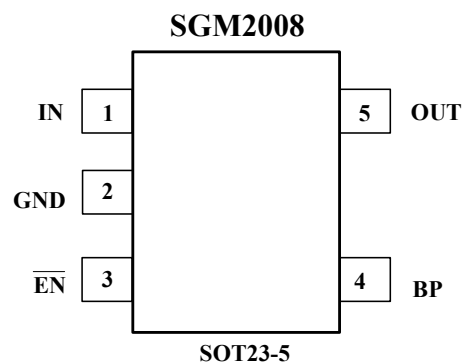

ORDERING INFORMATION

MODEL	V _{OUT} (V)	PIN-PACKAGE	SPECIFIED TEMPERATURE RANGE	ORDERING NUMBER	PACKAGE MARKING	PACKAGE OPTION
SGM2008-1.8	1.8V	SOT23-5	- 40°C to +125°C	SGM2008-1.8XN5/TR	X818	Tape and Reel, 3000
SGM2008-2.5	2.5V	SOT23-5	- 40°C to +125°C	SGM2008-2.5XN5/TR	X825	Tape and Reel, 3000
SGM2008-2.7	2.7V	SOT23-5	- 40°C to +125°C	SGM2008-2.7XN5/TR	X827	Tape and Reel, 3000
SGM2008-2.8	2.8V	SOT23-5	- 40°C to +125°C	SGM2008-2.8XN5/TR	X828	Tape and Reel, 3000
SGM2008-2.85	2.85V	SOT23-5	- 40°C to +125°C	SGM2008-2.85XN5/TR	X82J	Tape and Reel, 3000
SGM2008-2.9	2.9V	SOT23-5	- 40°C to +125°C	SGM2008-2.9XN5/TR	X829	Tape and Reel, 3000
SGM2008-3.0	3.0V	SOT23-5	- 40°C to +125°C	SGM2008-3.0XN5/TR	X830	Tape and Reel, 3000
SGM2008-3.3	3.3V	SOT23-5	- 40°C to +125°C	SGM2008-3.3XN5/TR	X833	Tape and Reel, 3000
SGM2008-3.6	3.6V	SOT23-5	- 40°C to +125°C	SGM2008-3.6XN5/TR	X836	Tape and Reel, 3000

ABSOLUTE MAXIMUM RATINGS

IN to GND.....- 0.3V to +6V
 Output Short-Circuit DurationInfinite
 \overline{EN} to GND.....- 0.3V to +6V
 OUT, BP to GND.....- 0.3V to (V_{IN} + 0.3V)
 Power Dissipation, P_D @ T_A = 25°C
 SOT23-50.4W

Package Thermal Resistance
 SOT23-5, θ_{JA} 250°C/W
 Operating Temperature Range.....- 40°C to +125°C
 Junction Temperature.....+150°C
 Storage Temperature.....- 65°C to +150°C
 Lead Temperature (soldering, 10s).....260°C

Stresses beyond those listed under “Absolute Maximum Ratings” may cause permanent damage to the device. These are stress ratings only, and functional operation of the device at these or any other conditions beyond those indicated in the operational sections of the specifications is not implied. Exposure to absolute maximum rating conditions for extended periods may affect device reliability.

ELECTRICAL CHARACTERISTICS

($V_{IN} = V_{OUT(NOMINAL)} + 0.5V^{(1)}$, $T_A = -40^{\circ}C$ to $+125^{\circ}C$, unless otherwise noted. Typical values are at $T_A = +25^{\circ}C$.)

PARAMETER	SYMBOL	CONDITIONS	MIN	TYP	MAX	UNITS	
Input Voltage	V_{IN}		2.5		5.5	V	
Output Voltage Accuracy ⁽¹⁾		$I_{OUT} = 1mA$ to $300mA$, $T_A = +25^{\circ}C$ $V_{OUT} + 0.5V \leq V_{IN} \leq 5.5V$	-3		+3	%	
Maximum Output Current			300			mA	
Current Limit	I_{LIM}		310	750		mA	
Ground Pin Current	I_Q	No load, $\overline{EN} = 0.4V$		77	145	μA	
		$I_{OUT} = 300mA$, $\overline{EN} = 0.4V$		200			
Dropout Voltage ⁽²⁾		$I_{OUT} = 1mA$		0.8		mV	
		$I_{OUT} = 300mA$		300	380		
Line Regulation ⁽¹⁾	ΔV_{LNR}	$V_{IN} = 2.5V$ or $(V_{OUT} + 0.5V)$ to $5.5V$, $I_{OUT} = 1mA$		0.03	0.15	%/V	
Load Regulation	ΔV_{LDR}	$I_{OUT} = 0.1mA$ to $300mA$, $C_{OUT} = 1\mu F$		0.0008	0.002	%/mA	
Output Voltage Noise	e_n	$f = 10Hz$ to $100KHz$, $C_{BP} = 0.01\mu F$, $C_{OUT} = 10\mu F$		30		$\mu VRMS$	
Power Supply Rejection Rate	PSRR	$C_{BP} = 0.1\mu F$, $I_{LOAD} = 50mA$, $C_{OUT} = 1\mu F$	$f = 100Hz$,		78		dB
			$f = 1KHz$,		73		dB
SHUTDOWN							
\overline{EN} Input Threshold	V_{IH}	$V_{IN} = 2.5V$ to $5.5V$		2.0			V
	V_{IL}						
\overline{EN} Input Bias Current	$I_{B(SHDN)}$	$\overline{EN} = 0V$ and $\overline{EN} = 5.5V$	$T_A = +25^{\circ}C$		0.01	1	μA
			$T_A = +125^{\circ}C$		0.01		
Shutdown Supply Current	$I_{Q(SHDN)}$	$\overline{EN} = 2.0V$	$T_A = +25^{\circ}C$		0.01	1	μA
			$T_A = +125^{\circ}C$		0.01		
Shutdown Exit Delay ⁽³⁾		$C_{BP} = 0.01\mu F$ $C_{OUT} = 1\mu F$, No load	$T_A = +25^{\circ}C$		30		μs
THERMAL PROTECTION							
Thermal Shutdown Temperature	T_{SHDN}				160		$^{\circ}C$
Thermal Shutdown Hysteresis	ΔT_{SHDN}				15		$^{\circ}C$

Specifications subject to change without notice.

Note 1: $V_{IN} = V_{OUT(NOMINAL)} + 0.5V$ or $2.5V$, whichever is greater.

Note 2: The dropout voltage is defined as $V_{IN} - V_{OUT}$, when V_{OUT} is $100mV$ below the value of V_{OUT} for $V_{IN} = V_{OUT} + 0.5V$. (Only applicable for $V_{OUT} = +2.5V$ to $+5.0V$.)

Note 3: Time needed for V_{OUT} to reach 95% of final value.

TYPICAL OPERATION CIRCUIT

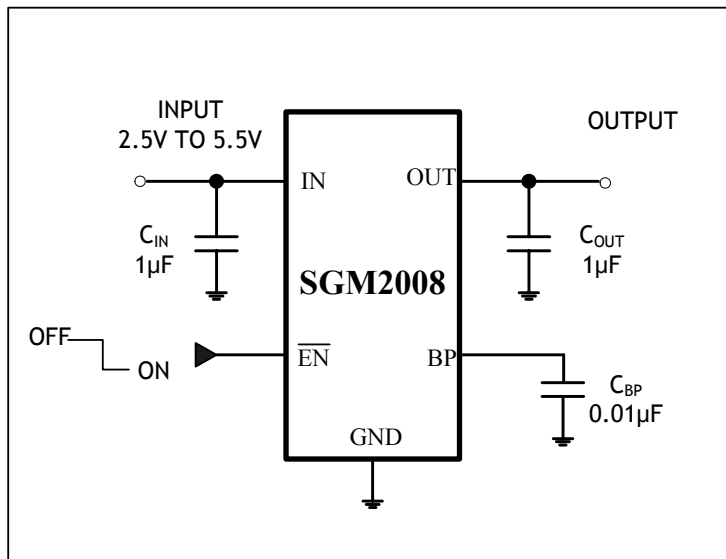

PIN DESCRIPTION

PIN	NAME	FUNCTION
1	IN	Regulator Input. Supply voltage can range from 2.5V to 5.5V. Bypass with a 1µF capacitor to GND.
2	GND	Ground.
3	\overline{EN}	Shutdown Input. A high reduces the supply current to 10nA. Connect to GND for normal operation.
4	BP	Reference-Noise Bypass. Bypass with a low-leakage 0.01µF ceramic capacitor for reduced noise at the output.
5	OUT	Regulator Output.

TYPICAL OPERATING CHARACTERISTICS

$V_{IN} = V_{OUT(NOMINAL)} + 0.5V$ or $2.5V$ (whichever is greater), $C_{IN} = 1\mu F$, $C_{OUT} = 1\mu F$, $C_{BP} = 0.01\mu F$, $T_A = +25^\circ C$, unless otherwise noted.

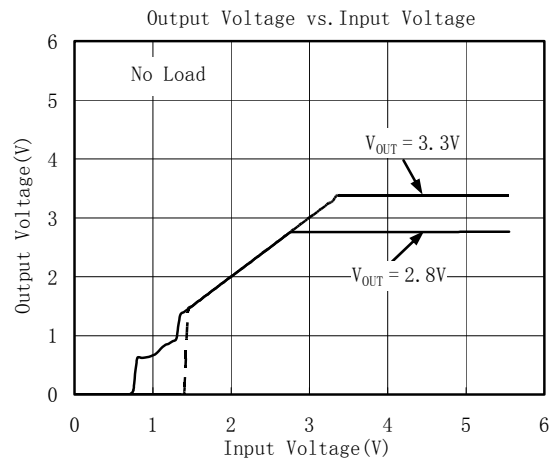
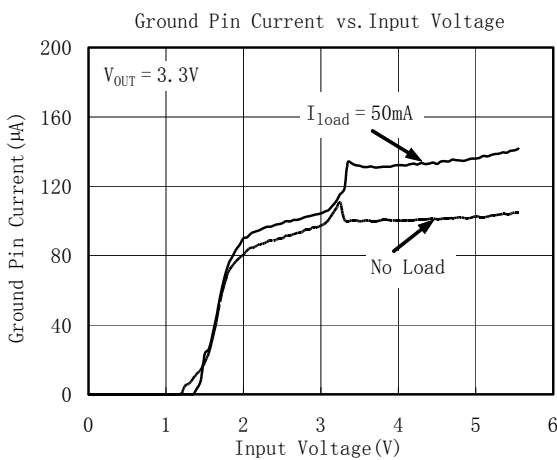
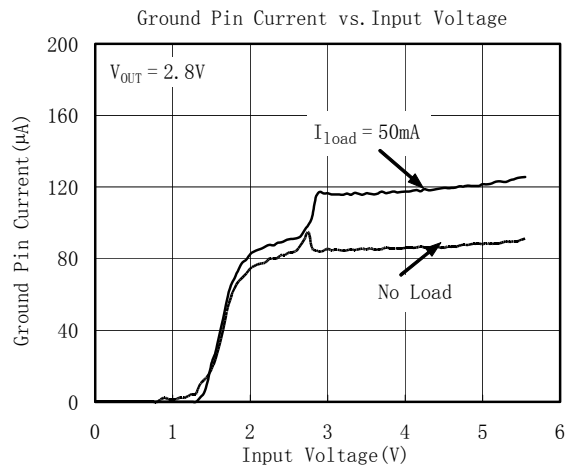
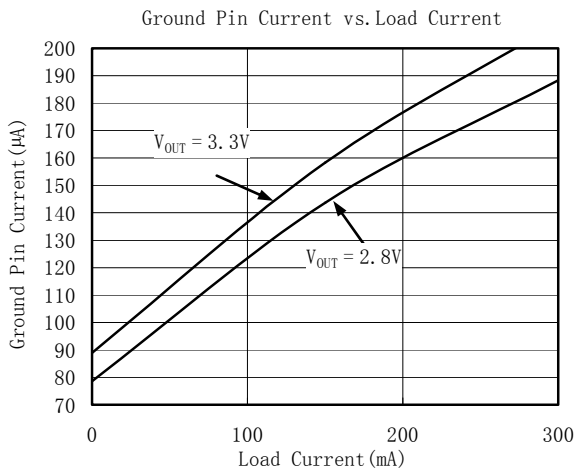
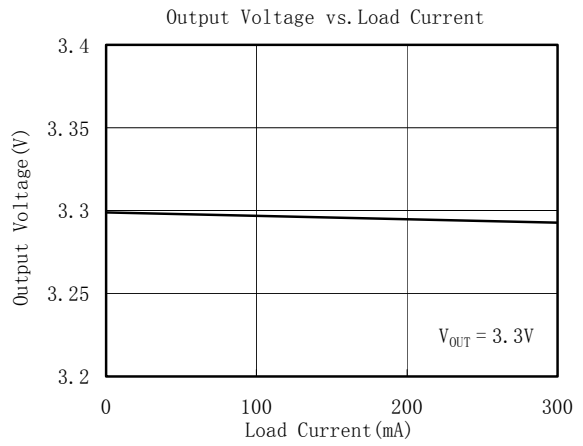
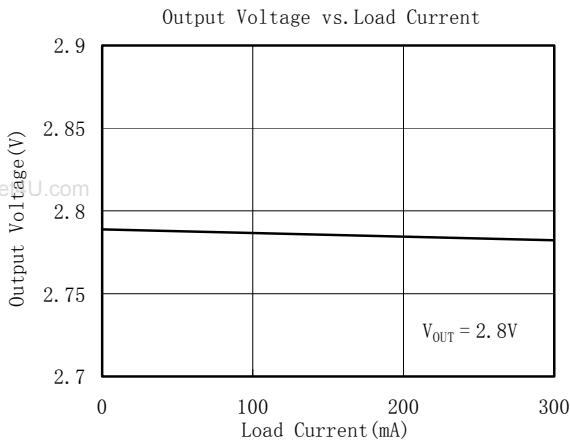

TYPICAL OPERATING CHARACTERISTICS

$V_{IN} = V_{OUT(NOMINAL)} + 0.5V$ or $2.5V$ (whichever is greater), $C_{IN} = 1\mu F$, $C_{OUT} = 1\mu F$, $C_{BP} = 0.01\mu F$, $T_A = +25^\circ C$, unless otherwise noted.

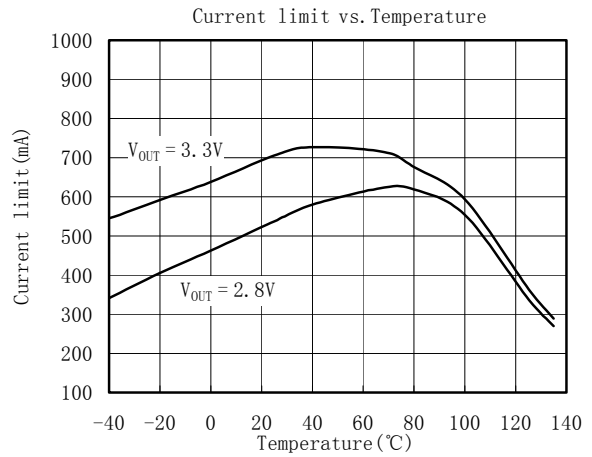
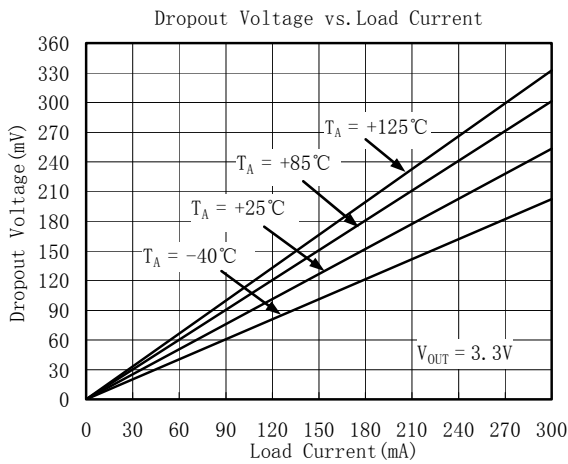
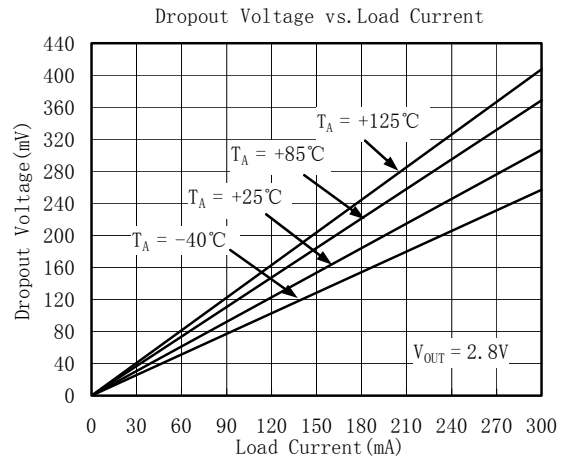
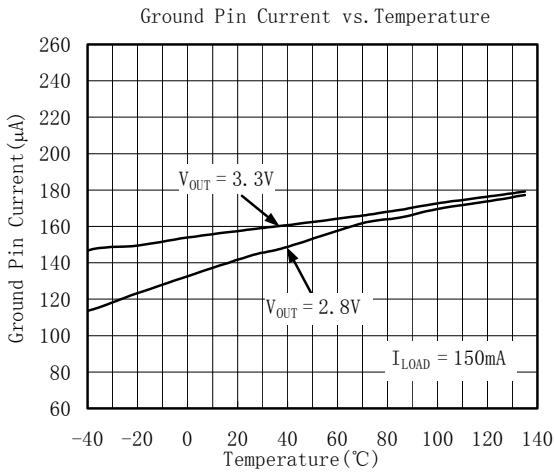
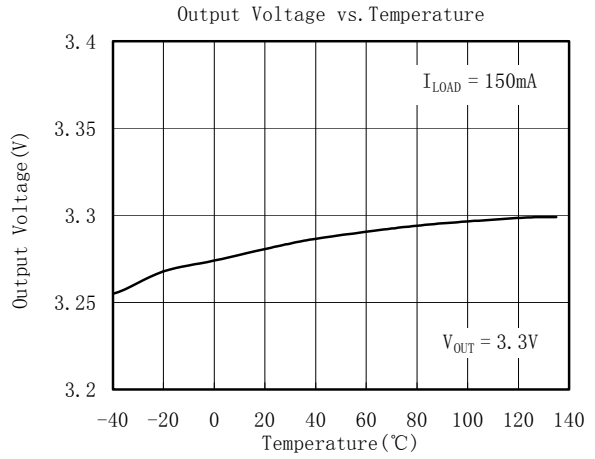
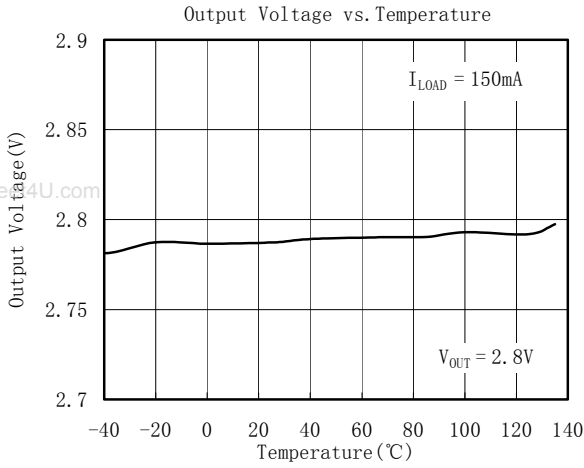

TYPICAL OPERATING CHARACTERISTICS

$V_{IN} = V_{OUT(NOMINAL)} + 0.5V$ or $2.5V$ (whichever is greater), $C_{IN} = 1\mu F$, $C_{OUT} = 1\mu F$, $C_{BP} = 0.01\mu F$, $T_A = +25^\circ C$, unless otherwise noted.

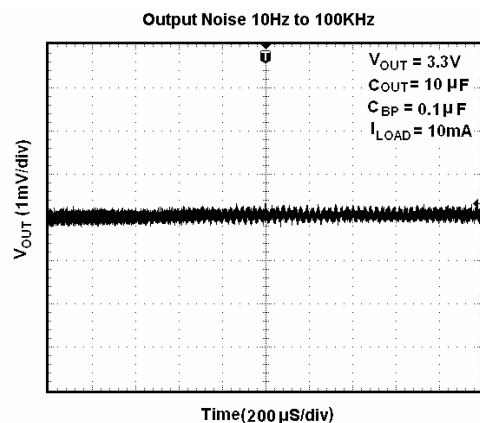
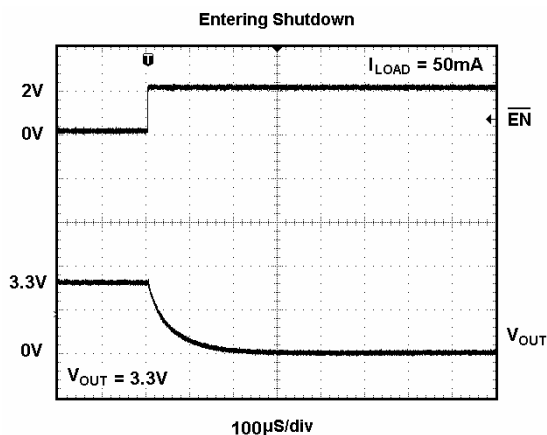
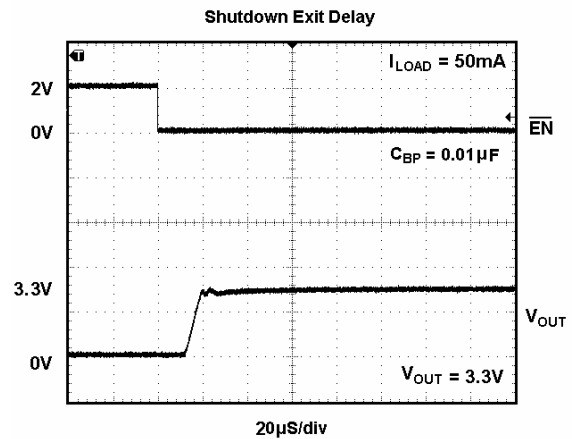
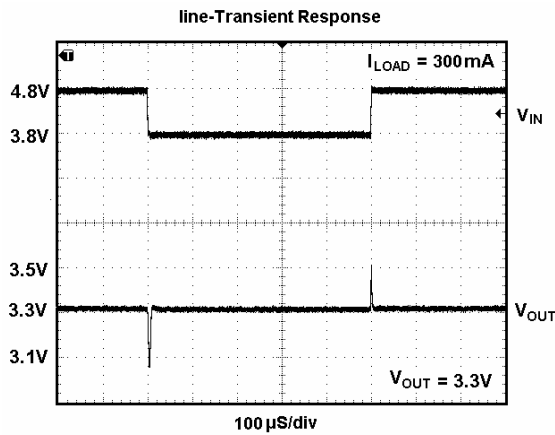
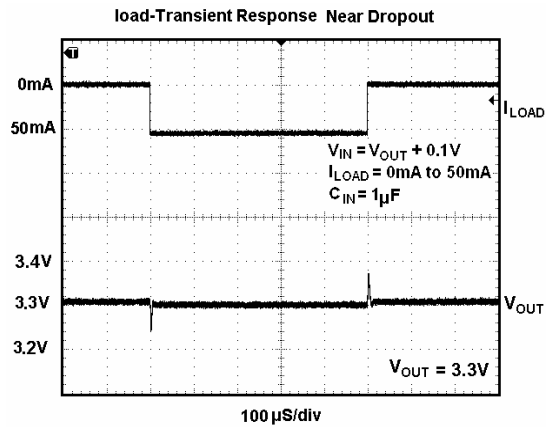
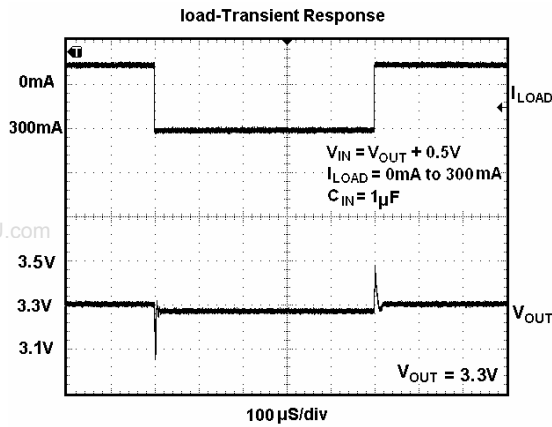

TYPICAL OPERATING CHARACTERISTICS

$V_{IN} = V_{OUT(NOMINAL)} + 0.5V$ or $2.5V$ (whichever is greater), $C_{IN} = 1\mu F$, $C_{OUT} = 1\mu F$, $C_{BP} = 0.01\mu F$, $T_A = +25^\circ C$, unless otherwise noted.

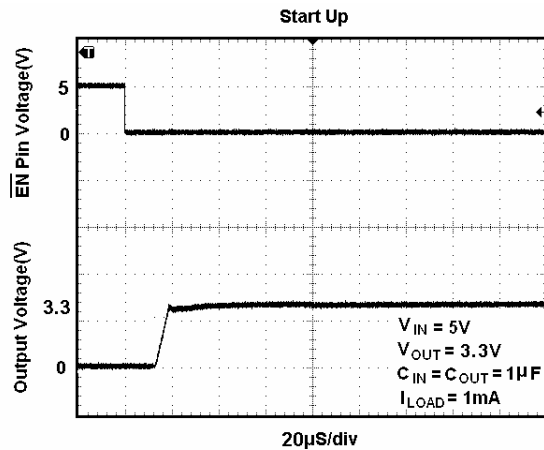
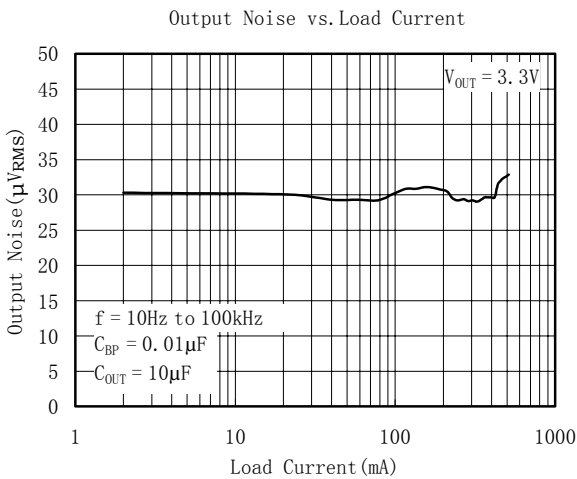
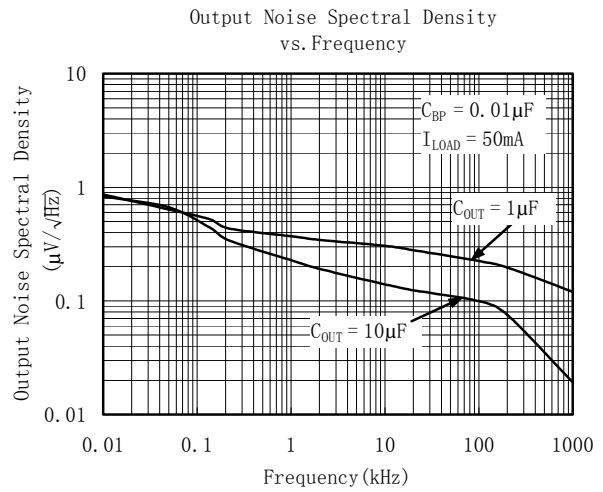
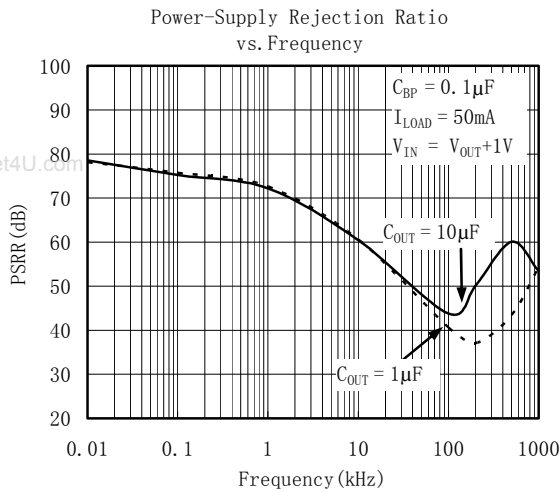

Application Notes

When LDO is used in handheld products, Attention must be paid to voltage spike which would damage SGM2008. In such applications, voltage spike will be generated at charger interface and V_{BUS} pin of USB interface when charger adapters and USB equipments are hot-inserted. Besides this, handheld products will be tested on the production line on the condition of no battery. Test Engineer will apply power from the connector pin which connects with positive pole of the battery. When external power supply is turned on suddenly, the voltage spike will be generated at the battery connector. The voltage spike will be very high, it always exceeds the absolute maximum input voltage (6.0V) of LDO. In order to get robust design. Design Engineer needs to clear up this voltage spike. Zener diode is a cheap and effective solution to eliminate such voltage spike. For example, BZM55B5V6 is a 5.6V small package Zener diode which can be used to remove voltage spike in cell phone design. The schematic is shown in below:

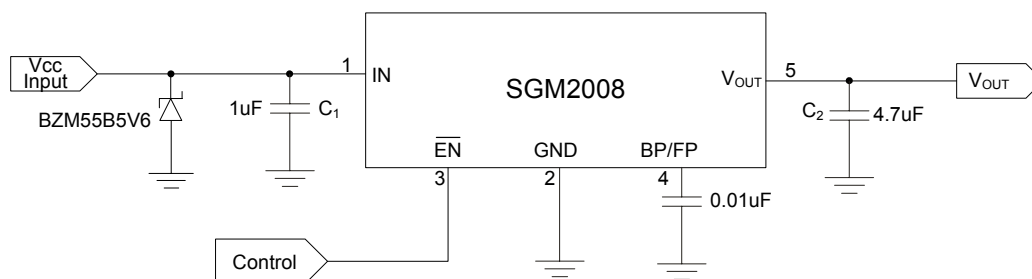

PACKAGE OUTLINE DIMENSIONS

SOT23-5

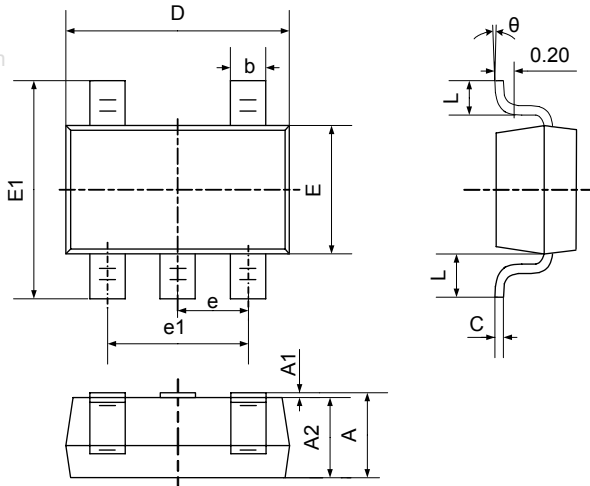

Symbol	Dimensions In Millimeters		Dimensions In Inches	
	Min	Max	Min	Max
A	1.050	1.250	0.041	0.049
A1	0.000	0.100	0.000	0.004
A2	1.050	1.150	0.041	0.045
b	0.300	0.400	0.012	0.016
c	0.100	0.200	0.004	0.008
D	2.820	3.020	0.111	0.119
E	1.500	1.700	0.059	0.067
E1	2.650	2.950	0.104	0.116
e	0.950TYP		0.037TYP	
e1	1.800	2.000	0.071	0.079
L	0.700REF		0.028REF	
L1	0.300	0.600	0.012	0.024
theta	0°	8°	0°	8°