

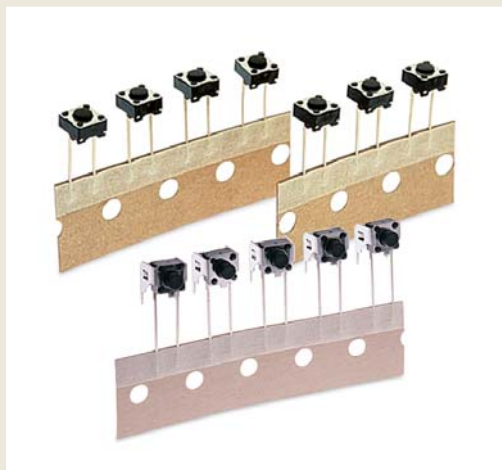

SERIES TL59/TL58 SWITCHES

TACT SWITCHES RADIAL LEAD



SPECIFICATIONS

Contact Rating:	50mA @ 12 VDC
Life Expectancy:	100,000 cycles
Contact Resistance:	100mΩ max., typical @ 2-4 VDC 100mA for both silver plated contacts
Insulation Resistance:	100mΩ min.
Dielectric Strength:	250 VAC
Actuation Force:	100 ± 50 gf, 160 ± 50 gf, 260 ± 50 gf
Operating Temperature:	-20°C to 70°C
Travel:	0.25 Typ

MATERIALS

Housing:	Polybutylene Terephthalate (PBT) or 6/6 Nylon
Actuator:	Polybutylene Terephthalate (PBT) or 6/6 Nylon
Bracket/Cover:	Tin plated steel
Contacts:	Silver plated phosphor bronze
Terminals:	Silver plated brass

FEATURES & BENEFITS

- ▶ Designed for automatic feed
- ▶ Radial lead packaging

APPLICATIONS/MARKETS

- ▶ Telecommunications
- ▶ Consumer Electronics
- ▶ Audio/visual
- ▶ Medical
- ▶ Testing/instrumentation
- ▶ Computer/servers/peripherals

HOW TO ORDER

SERIES	MODEL NO.	ACTUATOR ("L" Dimension)	OPERATING FORCE	CONTACT MATERIAL
TL	59	N = 4.3mm A = 5.0mm B = 9.5mm C = 8.0mm F = 7.0mm E = 7.3mm P = 8.5mm SP = 2.8mm <input type="checkbox"/>	F100 F160 F260	Q = Silver

Example Ordering Number

TL-59-N-F160-Q

- Square Snap-on Actuator Head
"L" Dimension is 7.5mm

TL	58 Right Angle	V = 3.85mm W = 3.15mm X = 4.75mm	F100 F160 F260	Q = Silver
----	-------------------	--	----------------------	------------

Specifications subject to change without notice.

SERIES TL59/TL58 SWITCHES

TACT SWITCHES RADIAL LEAD

TACT SWITCHES

TL 59

STANDARD RADIAL LEAD

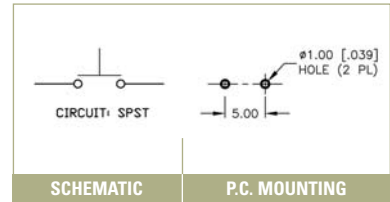
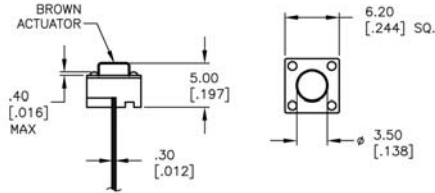
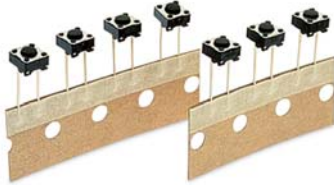

NAVIGATION SWITCHES

PUSHBUTTON SWITCHES

TOGGLE SWITCHES

ROCKER SWITCHES

SLIDE SWITCHES

SNAP-ACTION SWITCHES

DIP SWITCHES

KEYLOCK SWITCHES

ROTARY SWITCHES

DETECTOR SWITCHES

CAP OPTIONS

Actuator Length (L) in mm		
N = 4.3	C = 8.0	P = 8.5
A = 5.0	F = 7.0	SP = 2.8
B = 9.5	E = 7.3	

Operating Force	
F100 = 100 ± 50gf	
F160 = 160 ± 50gf	
F260 = 260 ± 50gf	

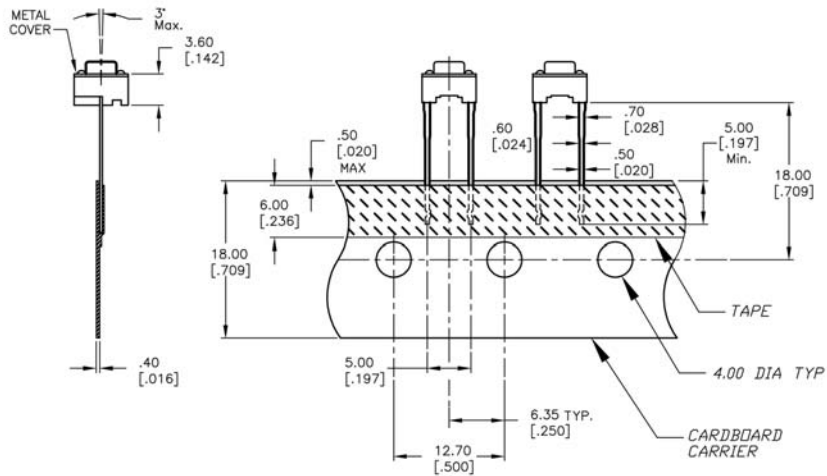

TL 58

RIGHT ANGLE RADIAL LEAD

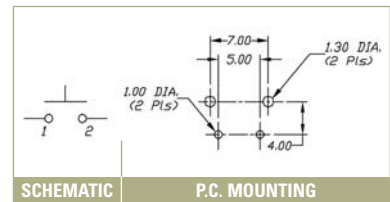
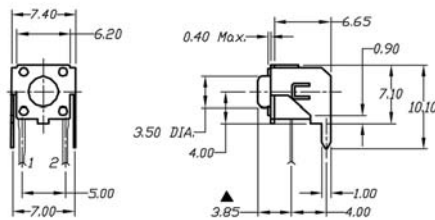
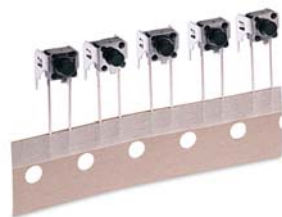

Actuator Length (L) in mm	
V = 3.85	
W = 3.15	
X = 4.75	

Operating Force	
F100 = 100 ± 50gf	
F160 = 160 ± 50gf	
F260 = 260 ± 50gf	

