

SPECIFICATION FOR LCD MODULE

Model No. TM160160BCBWT2

Prepared by:	Date:
Checked by :	Date:
Verified by :	Date:
Approved by:	Date:

TIANMA MICROELECTRONICS CO., LTD

1. General Specifications:

- 1.1 Display type: FSTN with Built-In Touchscreen
- 1.2 Display color*:
 - Display color: Blue-Black
 - Background: White
- 1.3 Polarizer mode: Transflective/Positive
- 1.4 Viewing Angle: 6:00
- 1.5 Driving Method: 1/160Duty 1/13 Bias
- 1.6 Backlight: EL(Blue)
- 1.7 Data Transfer: Parallel
- 1.8 Operating Temperature: -20-----+70°C
 - Storage Temperature: -30-----+80°C
- 1.9 Outline Dimensions: Refer to outline drawing on next page
- 1.10 Dot Matrix: 160 X 160
- 1.11 Dot Size: 0.33X0.35(mm)
- 1.12 Dot Pitch: 0.345X0.365 (mm)
- 1.13 Weight: 40g

* Color tone is slightly changed by temperature and driving voltage.

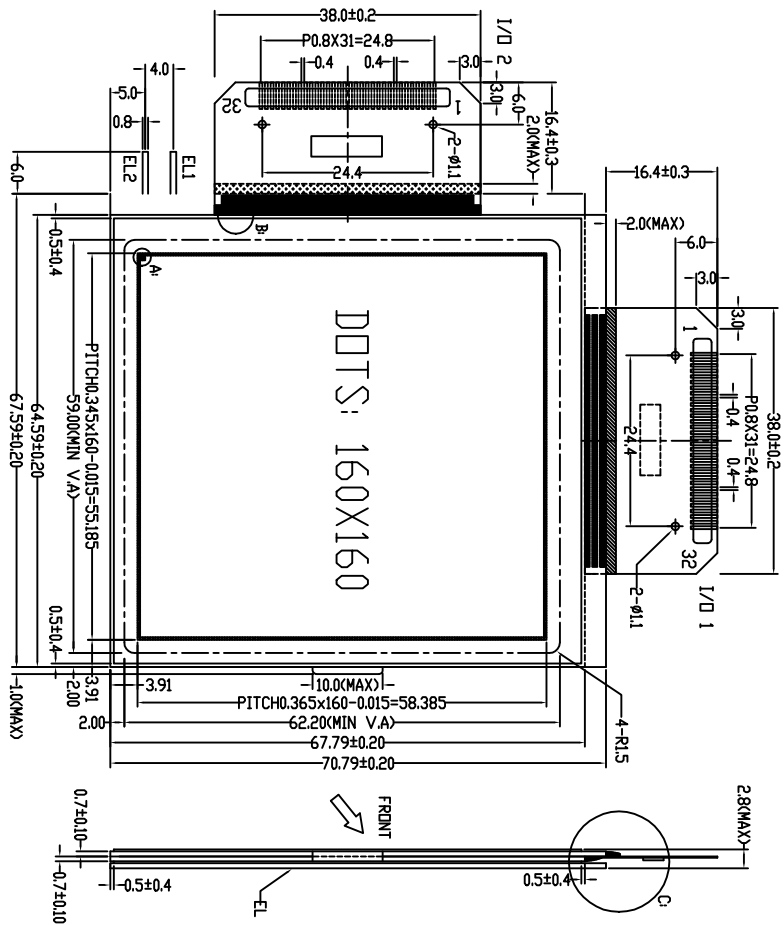

- NOTES:
- | | |
|---------------------------|------------------------|
| 1. DISPLAY TYPE: | STN/B-W MODE |
| 2. VIEWING DIRECTION: | 6:00 |
| 3. POLARIZER MODE: | TRANSFLECTIVE/POSITIVE |
| 4. DRIVE METHOD: | 1/160 DUTY 1/13 BIAS |
| 5. LCD OPERATING VOLTAGE: | 17.5V |
| 6. OPERATING TEMP.: | -20°C-+70°C |
| 7. STORAGE TEMP.: | -30°C-+80°C |
| 8. IC: | NT7701H-TABF3 x 2 |
| 9. VDD=5.0V | |
| 10. FRONT POLARIZER: | TMS-G1225-570 |
| REAR POLARIZER: | LN-1205HN-33 |
| 11. BACKLIGHT: | EL(BLUE) |
| 12. UNMARKED TOLERANCES: | ±0.3mm |

PIN	SYMBOL	PIN	SYMBOL
1	DUMMY	17	D5
2	VOR	18	D4
3	V12R	19	D3
4	V43R	20	D2
5	V5R	21	D1
6	VSS	22	D0
7	TEST2	23	ETD2
8	TEST1	24	S/C
9	MD	25	VDD
10	FR	26	L/R
11	ETD1	27	VSS
12	LP	28	V5L
13	DISPDEF	29	V43L
14	XCK	30	V12L
15	D7	31	VOL
16	D6	32	DUMMY

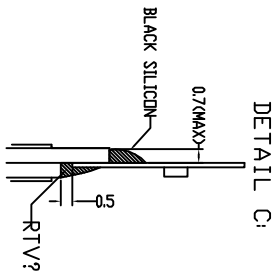
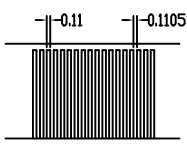
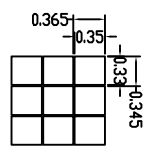

SEE TOUCHSCREEN SPEC ON SEPARATE PAGE



TIAN-MA MICROELECTRONICS CO.

6/F., CASTIC Building, Sherman Road, Central, Shenzhen, China

DRAWN BY:	6/F., CASTIC Building, Sherman Road, Central, Shenzhen, China	TITLE: TM160160BCBW12	SCALE:
CHECKED BY:		DWG NO: G-2	UNIT: mm
APPROVED BY:		DWG NAME: TM160160BCBW12-4	SHEET NO: 0F
CONTROLLED BY:			

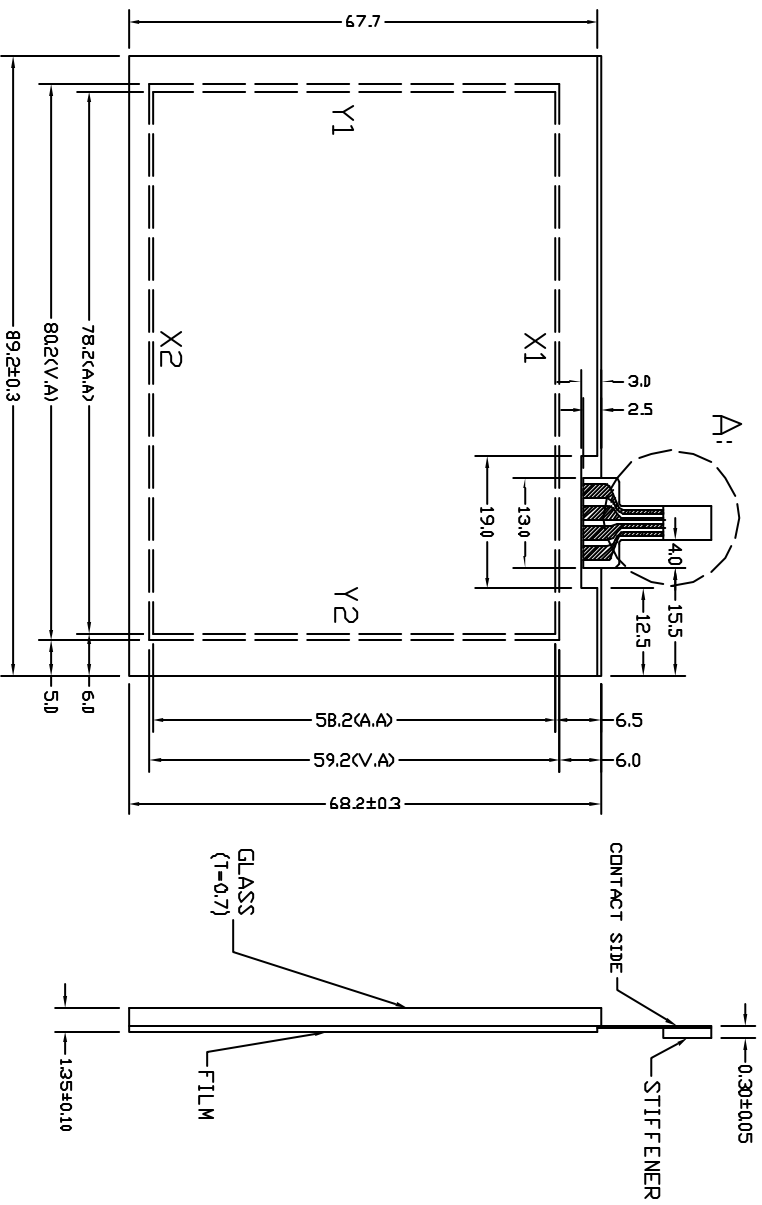



TOUCH PANEL PINS:

PIN	ASSIGNMENT
1	Y1
2	X1
3	Y2
4	X2

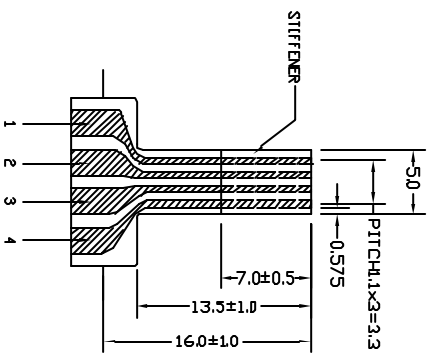
DETAIL A:



NOTE:
ALL UNMARKED TOLERANCE: 0.2mm

 <p>TAN-MA MICROELECTRONICS CO. 22/F., HANGOU Building, Shennan Road, Central, Shenzhen, China</p>		<p>SCALE: </p>	
DRAWN BY:	TP1-1	DWG NO:	TP1-1
CHECKED BY:		DWG NAME:	TP1-1
APPROVED BY:		SHEET NO:	02

3 LCD Module Part Numbering System

TM 160160 B C B W T 2

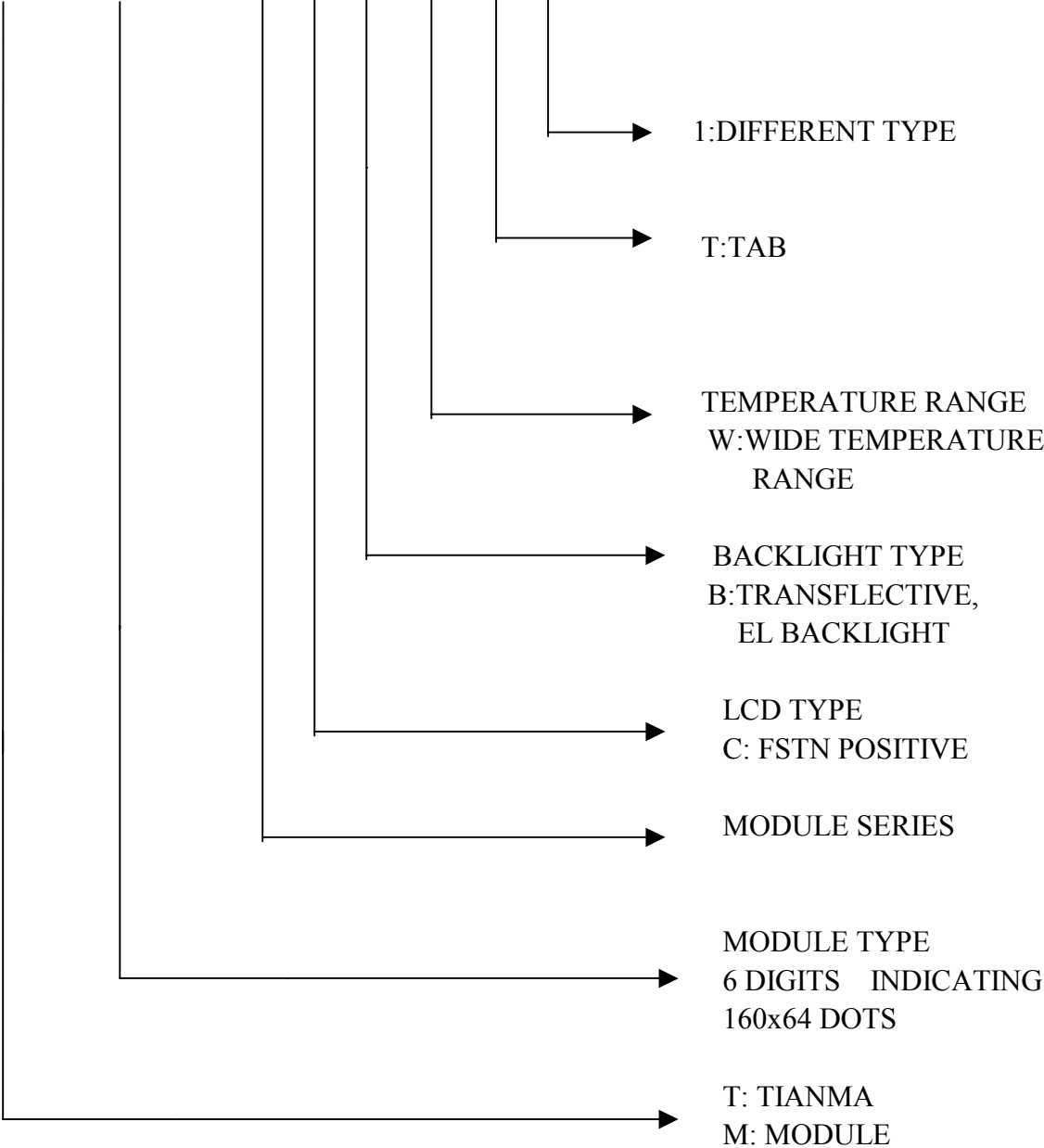

4 Circuit Block Diagram

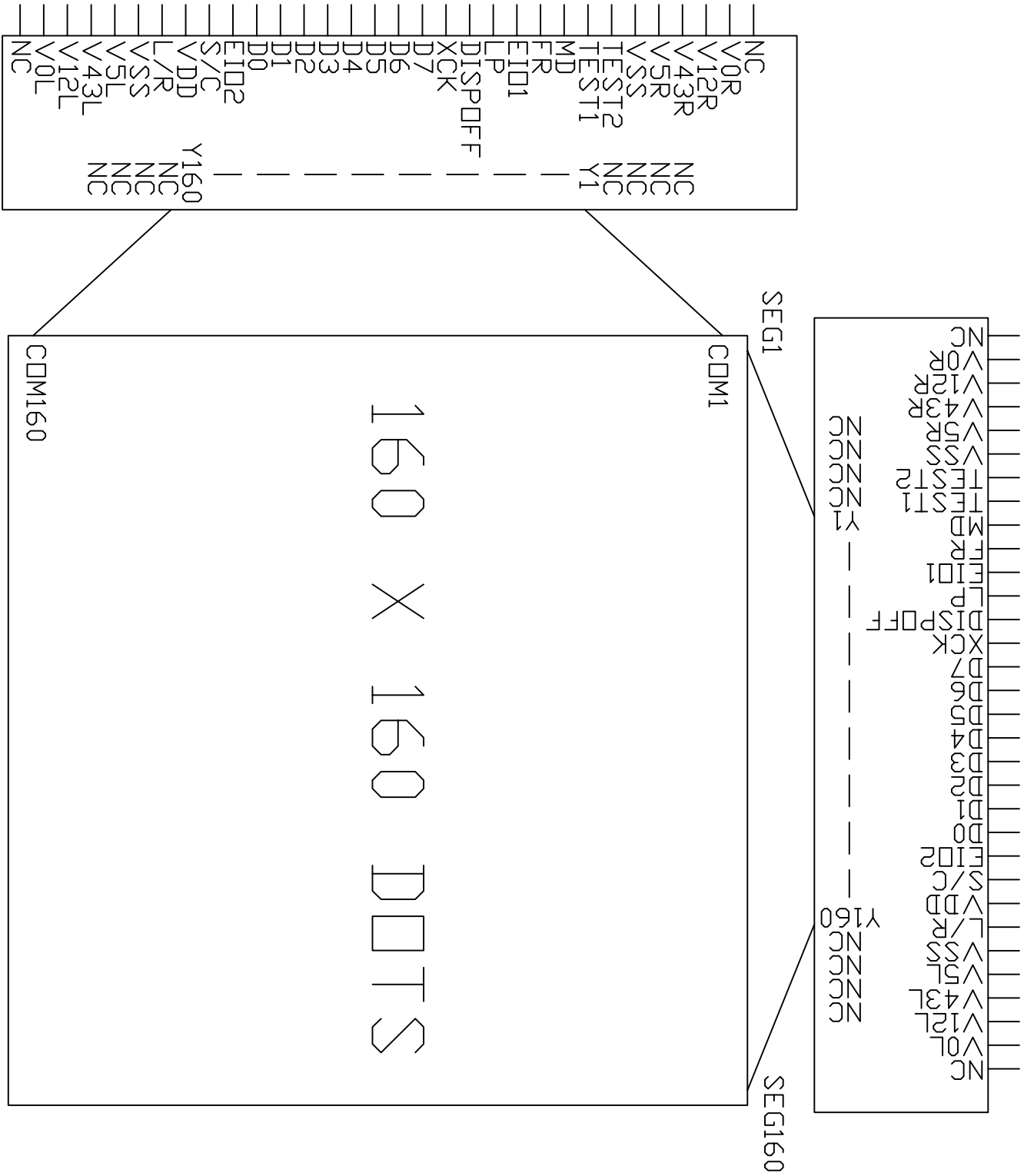

5 Absolute Maximum Ratings

Item	Symbol	Min.	Max.	Unit	Remark
Power Supply Voltage	$V_{DD}-V_{SS}$	-	7.0	V	
LCD Driving Voltage	V_{LCD}	15.0	30.0		
Operating Temperature Range	T_{OP}	-20	+70	°C	No Condensation
Storage Temperature Range	T_{ST}	-30	+80		

6 Electrical Specifications and Instruction Code

6.1 Electrical characteristics

Item		Symbol	Min.	Typ.	Max.	Unit
Supply Voltage (Logic)		$V_{DD}-V_{SS}$	2.5	-	5.5	V
Supply Voltage (LCD Drive)		V_{LCD} ($V_{DD}-V_0$)	17.0	17.5	18.0	V
Input Signal Voltage	High	V_{IH} ($V_{DD}=5.0$)	$0.8V_{DD}$	-	V_{DD}	V
	Low	V_{IL} ($V_{DD}=3.0$)	0	-	$0.2 V_{DD}$	V
Supply current (Logic)		I_{DD} ($V_{DD}-V_{SS}=5.0V$)	-	-	500	uA
Power Supply For EL Backlight Current		-	-	100	-	Vrms
			-	400	-	Hz

6.2 Interface Signals

Pin No.	Symbol	Level	Description
1	DUMMY	-	-
2	V0R	-	Bias voltage
3	V12R	-	Bias voltage
4	V43R	-	Bias voltage
5	V5R	-	Bias voltage
6	VSS	0V	Ground
7	TEST2	-	Test pin
8	TEST1	-	Test pin
9	MD	H/L	Mode select
10	FR	-	Ac signal input
11	EI01	H/L	Input/Output pin
12	LP	H/L	Latch pulse input
13	DISPOFF	H/L	RESET PIN
14	XCK	H/L	Clock input
15	D7	H/L	Data bits 7
16	D6	H/L	Data bits 6
17	D5	H/L	Data bits 5
18	D4	H/L	Data bits 4
19	D3	H/L	Data bits 3
20	D2	H/L	Data bits 2
21	D1	H/L	Data bits 1
22	D0	H/L	Data bits 0
23	EIO2	H/L	Input/Output pin
24	S/C	H/L	Segment/Common select
25	VDD	5.0V	Power
26	L/R	H/L	Display data shift direction select
27	VSS	0V	Ground
28	V5L	-	Bias voltage
29	V43L	-	Bias voltage
30	V12L	-	Bias voltage
31	V0L	-	Bias voltage
32	DUMMY	-	-

6.3 Interface Timing Chart

Timing waveform of Segment Mode

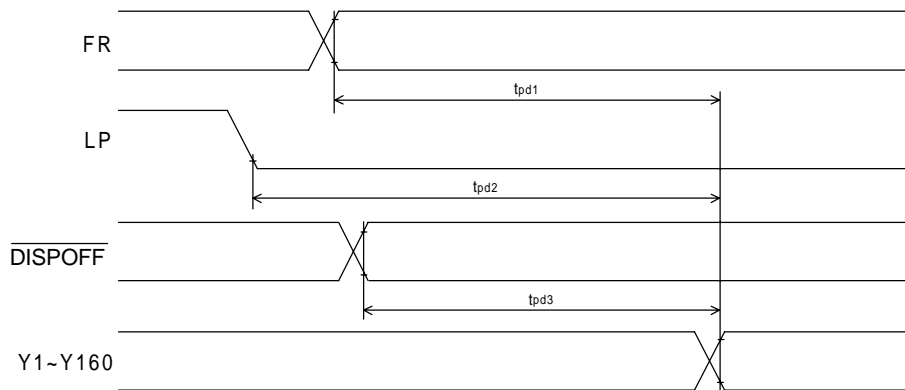
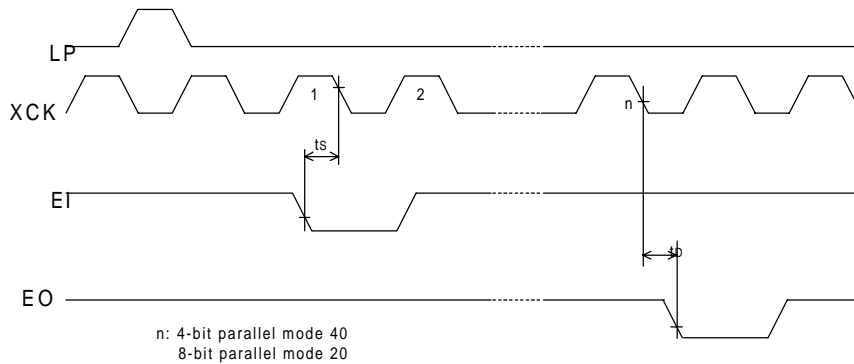
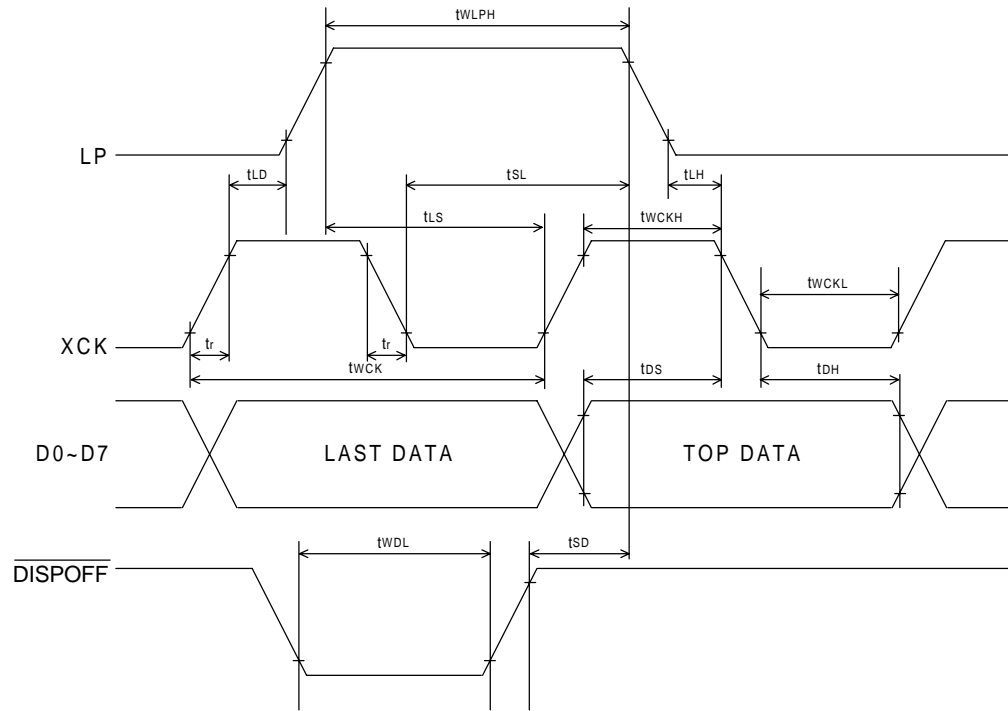

Timing Characteristics of Common Mode

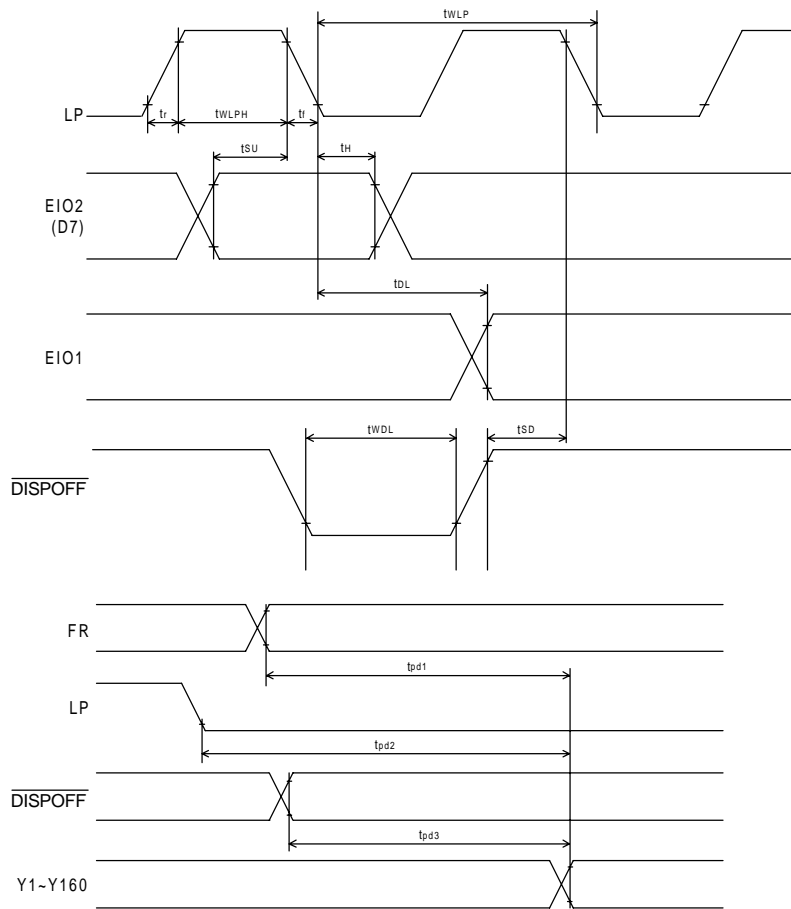

L/R="L"

7 Optical Characteristics

7.1 Optical Characteristics

Ta=25°C

Item	Symbol	Condition	Min.	Typ.	Max.	Unit	
Viewing Angle	θ_x	$C_r \geq 2$	$\theta_y = 0^\circ$	-30	--	20	Deg
	θ_y			$\theta_x = 0^\circ$	-30	--	
Contrast Ratio	C_r	$\theta_x = 0^\circ$ $\theta_y = 0^\circ$	3.0		-	-	
Response Time	Turn on	T_{on}	$\theta_x = 0^\circ$ $\theta_y = 0^\circ$	-	-	350	ms
	Turn off	T_{off}		-	-	350	

7.2 Definition of Optical Characteristics

7.2.1 Definition of Viewing Angle

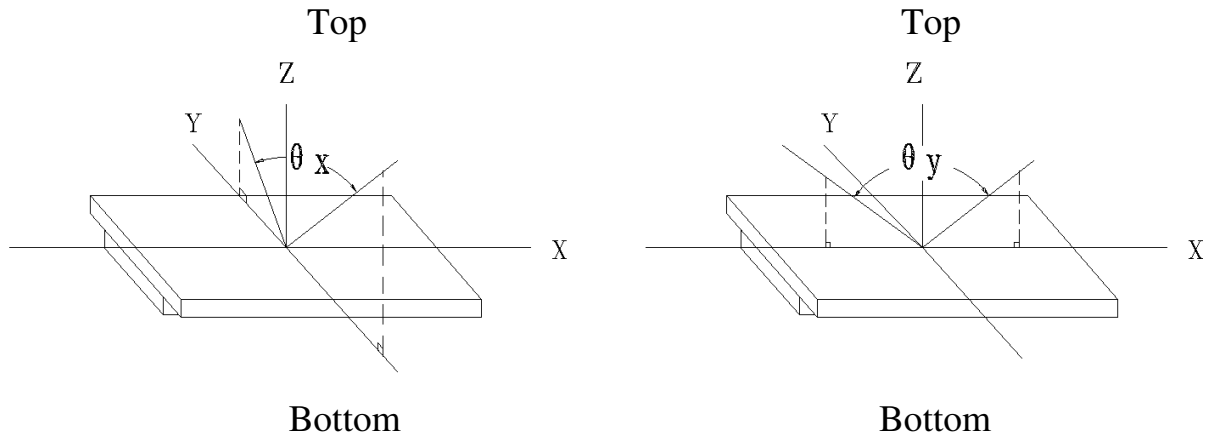

7.2.2 Definition of Contrast Ratio

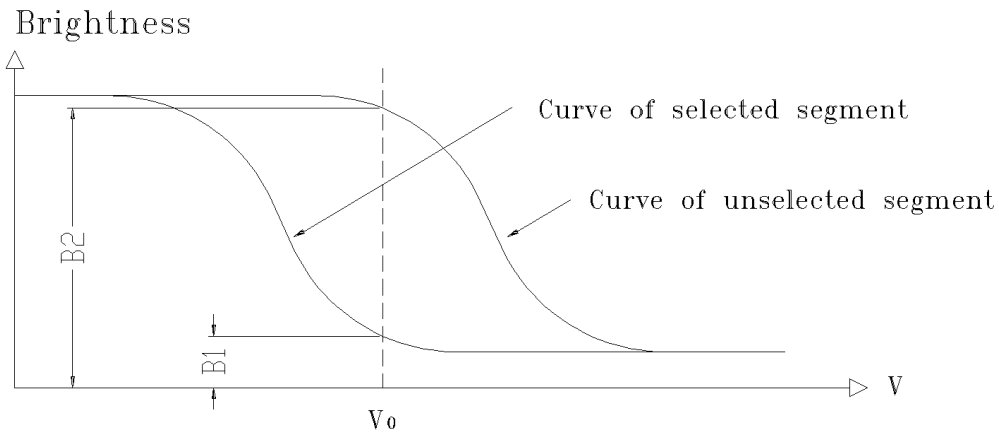

$$\text{Contrast Ratio} = B2/B1 = \frac{\text{unselected state brightness}}{\text{selected state brightness}}$$

Measuring Conditions:

- 1) Ambient Temperature: 25°C ;
- 2) Frame frequency: 80Hz

7.2.3 Definition of Response time

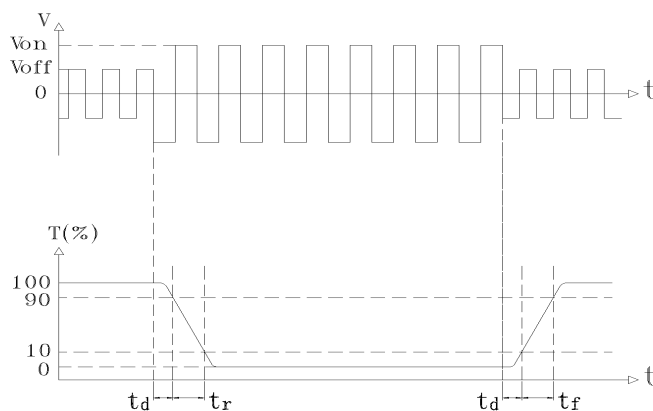

Turn on time: $t_{on} = t_d + t_r$ Turn off time: $t_{off} = t_d + t_f$

Measuring Condition:

- 1) Operating Voltage: 17.5V
- 2) Frame frequency: 80Hz

8 Reliability

8.1 Content of Reliability Test

Ta=25°C

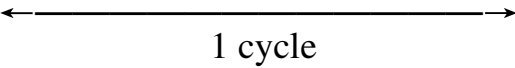
No.	Test Item	Content of Test	Test condition
1	High Temperature Storage	Endurance test applying the high storage temperature for a long time	80°C 240H
2	Low Temperature Storage	Endurance test applying the low storage temperature for a long time	-30°C 240H
3	High Temperature Operation	Endurance test applying the electric stress (voltage & current) and the thermal stress to the element for a long time	70°C 240H
4	Low Temperature Operation	Endurance test applying the electric stress under low temperature for a long time	-20°C 240H
5	High Temperature /Humidity Storage	Endurance test applying the high temperature and high humidity storage for a long time	60°C 95%RH 240H
6	Temperature Cycle	Endurance test applying the low and high temperature cycle $-30^{\circ}\text{C} \longleftrightarrow 25^{\circ}\text{C} \longleftrightarrow 80^{\circ}\text{C} \longleftrightarrow 25^{\circ}\text{C}$ $30\text{min} \quad 5\text{min} \quad 30\text{min} \quad 5\text{min}$ 	-30°C/80°C 10 cycles
7	Vibration Test (package state)	Endurance test applying the vibration during transportation	10Hz~500Hz, 100m/s ² , 120min
8	Shock Test (package state)	Endurance test applying the shock during transportation	Half- sine wave, 300m/s ² , 18ms
9	Atmospheric Pressure Test	Endurance test applying the atmospheric pressure during transportation by air	25kPa 16H

8.2 Failure Judgment Criterion

Criterion Item	Test Item No.									Failure Judgement Criterion
	1	2	3	4	5	6	7	8	9	
Basic Specification	√	√	√	√	√	√	√	√	√	Out of the basic Specification
Electrical specification	√	√	√	√	√					Out of the electrical specification
Mechanical Specification							√	√		Out of the mechanical specification
Optical Characteristic	√	√	√	√	√	√			√	Out of the optical specification
Note	For test item refer to 8.1									
Remark	Basic specification = Optical specification + Mechanical specification									

9 QUALITY LEVEL

Examination or Test	At $T_a=25^\circ\text{C}$ (unless otherwise stated)	Inspection				
		Min.	Max.	Unit	IL	AQL
External Visual Inspection	Under normal illumination and eyesight condition, the distance between eyes and LCD is 25cm.	See Appendix A			II	Major 1.0 Minor 2.5
Display Defects	Under normal illumination and eyesight condition, display on inspection.	See Appendix B			II	Major 1.0 Minor 2.5
Note: Major defects: Open segment or common, Short, Serious damages, Leakage Miner defects: Others Sampling standard conforms to GB2828						

10 Precautions for Use of LCD Modules

10.1 Handling Precautions

10.1.1 The display panel is made of glass. Do not subject it to a mechanical shock by dropping it from a high place, etc.

10.1.2 If the display panel is damaged and the liquid crystal substance inside it leaks out, be sure not to get any in your mouth, if the substance comes into contact with your skin or clothes, promptly wash it off using soap and water.

10.1.3 Do not apply excessive force to the display surface or the adjoining areas since this may cause the color tone to vary.

10.1.4 The polarizer covering the display surface of the LCD module is soft and easily scratched. Handle this polarizer carefully.

10.1.5 If the display surface is contaminated, breathe on the surface and gently wipe it with a soft dry cloth. If still not completely clear, moisten cloth with one of the following solvents:

- Isopropyl alcohol
- Ethyl alcohol

Solvents other than those mentioned above may damage the polarizer. Especially, do not use the following:

- Water
- Ketone
- Aromatic solvents

10.1.6 Do not attempt to disassemble the LCD Module.

10.1.7 If the logic circuit power is off, do not apply the input signals.

10.1.8 To prevent destruction of the elements by static electricity, be careful to maintain an optimum work environment.

- a. Be sure to ground the body when handling the LCD Modules.
- b. Tools required for assembly, such as soldering irons, must be properly ground.
- c. To reduce the amount of static electricity generated, do not conduct assembly and other work under dry conditions.
- d. The LCD Module is coated with a film to protect the display surface. Be care when peeling off this protective film since static electricity may be generated.

10.2 Storage precautions

10.2.1 When storing the LCD modules, avoid exposure to direct sunlight or to the light of fluorescent lamps.

10.2.2 The LCD modules should be stored under the storage temperature range. If the LCD modules will be stored for a long time, the recommend condition is:

Temperature : $0^{\circ}\text{C} \sim 40^{\circ}\text{C}$

Relatively humidity: $\leq 80\%$

10.2.3 The LCD modules should be stored in the room without acid, alkali and harmful gas.

10.3 The LCD modules should be no falling and violent shocking during transportation, and also should avoid excessive press, water, damp and sunshine.

Appendix A

Inspection items and criteria for appearance defects

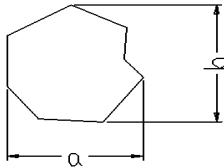
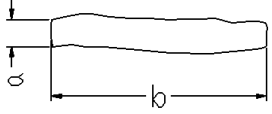
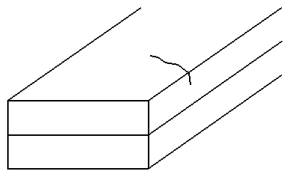
Items	Contents	Criteria		
Leakage		Not permitted		
Rainbow		According to the limit specimen		
Polarizer	Wrong polarizer attachment	Not permitted		
	Bubble between polarizer and glass	Not counted	Max. 3 defects allowed	
		$\phi < 0.3\text{mm}$	$0.3\text{mm} \leq \phi \leq 0.5\text{mm}$	
	Scratches of polarizer	According to the limit specimen		
Black spot (in viewing area)		Not counted	Max. 3 spots allowed	
		$X < 0.2\text{mm}$	$0.2\text{mm} \leq X \leq 0.5\text{mm}$	
		$X = (a+b)/2$		
Black line (in viewing area)		Not counted	Max. 3 lines allowed	
		$a < 0.02\text{mm}$	$0.02\text{mm} \leq a \leq 0.05\text{mm}$ $b \leq 2.0\text{mm}$	
Progressive cracks		Not permitted		

Appendix A

Inspection item and criteria for appearance defects (continued)

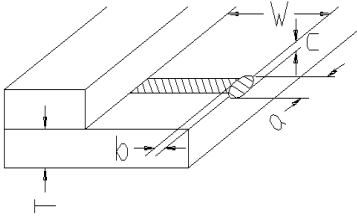
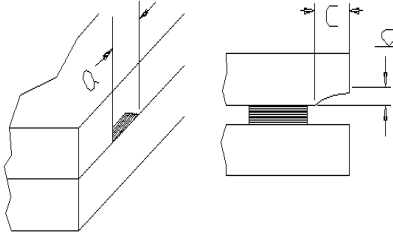
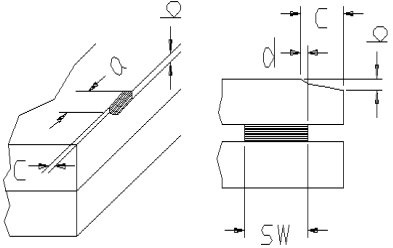
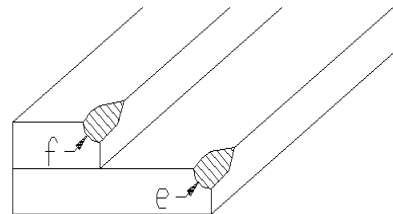
Items	Contents	Criteria				
Glass Cracks	Cracks on pads 	a	b	c	Max. 2 cracks allowed	Max. 5 cracks allowed
	$\leq 3\text{mm}$	$\leq W/5$	$\leq T/2$			
	$\leq 2\text{mm}$	$\leq W/5$	$T/2 < C < T$			
	Cracks on contact side 	a	b	Max. 2 cracks allowed		
	$\leq 3\text{mm}$	$\leq T/2$				
	$\leq 2\text{mm}$	$T/2 < b < T$				
	C shall be not reach the seal area					
	Cracks on non-contact side 	a	b	Max. 2 cracks allowed		
	$\leq 3\text{mm}$	$\leq T/2$				
	$\leq 2\text{mm}$	$T/2 < b < T$				
$C \leq 0.5\text{mm}$						
$d \leq SW/3$						
Corner cracks 	$e < 2.0\text{mm}^2$ $f < 2.0\text{mm}^2$		Max. 3 cracks allowed			

Appendix B

Inspection items and criteria for display defects

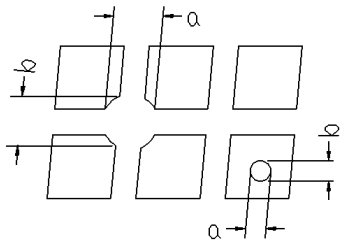
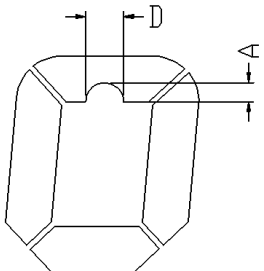
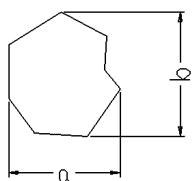
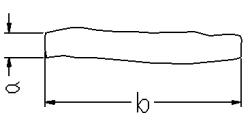
Items	Contents	Criteria		
Open segment or open common		Not permitted		
Short		Not permitted		
Wrong viewing angle		Not permitted		
Contrast ratio uneven		According to the limit specimen		
Crosstalk		According to the limit specimen		
Pin holes and cracks in segment (DOT)		Not counted	Max.3 dots allowed	Max.3 dots allowed
		$X < 0.1\text{mm}$	$0.1\text{mm} \leq X \leq 0.2\text{mm}$	
		$X = (a+b)/2$		
		Not counted	Max.2 dots allowed	
$A < 0.1\text{mm}$		$0.1\text{mm} \leq A \leq 0.2\text{mm}$ $D < 0.25\text{mm}$		
Black spot (in viewing area)		Not counted	Max.3 spots allowed	Max.3 spots (lines) allowed
		$X < 0.1\text{mm}$	$0.1\text{mm} \leq X \leq 0.2\text{mm}$	
		$X = (a+b)/2$		
Black line (in viewing area)		Not counted	Max.3 lines allowed	
		$a < 0.02\text{mm}$	$0.02\text{mm} \leq a \leq 0.05\text{mm}$ $b \leq 0.5\text{mm}$	

Appendix B

Inspection items and criteria for display defects (continued)

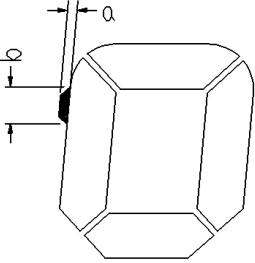
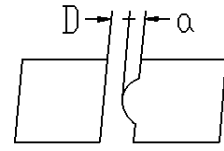
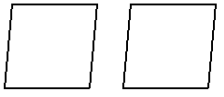
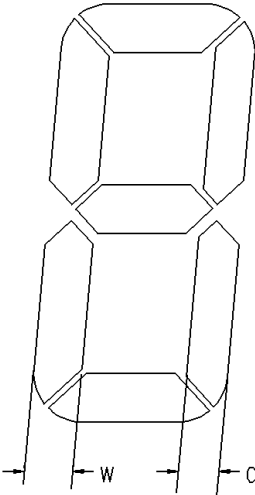
Items	Content	Criteria				
Transformation of segment		Not counted	Max. 2 defects allowed	Max.3 defects allowed		
		$x < 0.1\text{mm}$	$0.1\text{mm} \leq x \leq 0.2\text{mm}$			
		$x = (a+b)/2$				
		Not counted	Max. 1 defects allowed			
		$a < 0.1\text{mm}$	$0.1\text{mm} \leq a \leq 0.2\text{mm}$ $D > 0$			
		Max.2 defects allowed $0.8W \leq a \leq 1.2W$ $a = \text{measured value of width}$ $W = \text{nominal value of width}$				