

SPECIFICATION FOR LCD MODULE

Model No. TM160240ACAWG1

| | |
|----------------------|--------------|
| Prepared by: | Date: |
| Checked by : | Date: |
| Verified by : | Date: |
| Approved by: | Date: |

TIANMA MICROELECTRONICS CO., LTD

REVISION RECORD

| Date | Ver. | Ref. Page | Revision No. | Revision Item |
|-------------|-------------|------------------|---------------------|----------------------|
| | | | | |

1. General Specifications:

- 1.1 Display type: FSTN
- 1.2 Display color*¹:
 - Display color: Blue-black
 - Background: White
- 1.3 Polarizer mode: Reflective/Positive
- 1.4 Viewing Angle: 6:00
- 1.5 Driving Method: 1/240 Duty 1/13 Bias
- 1.6 Lcd operating voltage: 21.5V
- 1.7 Backlight: None
- 1.8 Driver: S6B0794X01-B0CZ + S6B0796X01-B0CZ
- 1.9 Data Transfer: 4 Bit Parallel
- 1.10 Operating Temperature: -20----+70°C
 - Storage Temperature: -30----+80°C
- 1.11 Outline Dimensions: Refer to outline drawing on next page
- 1.12 Dot Matrix: 160 X 240Dots
- 1.13 Dot Size: 0.22X0.22 (mm)
- 1.14 Dot Pitch: 0.24X0.24 (mm)
- 1.15 Weight: Approx 150g

*¹ Color tone is slightly changed by temperature and driving voltage.

TOP VIEW

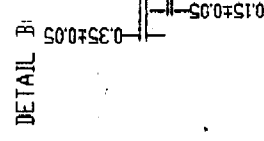
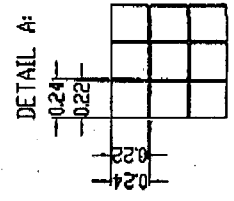
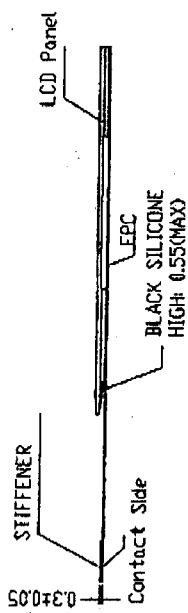
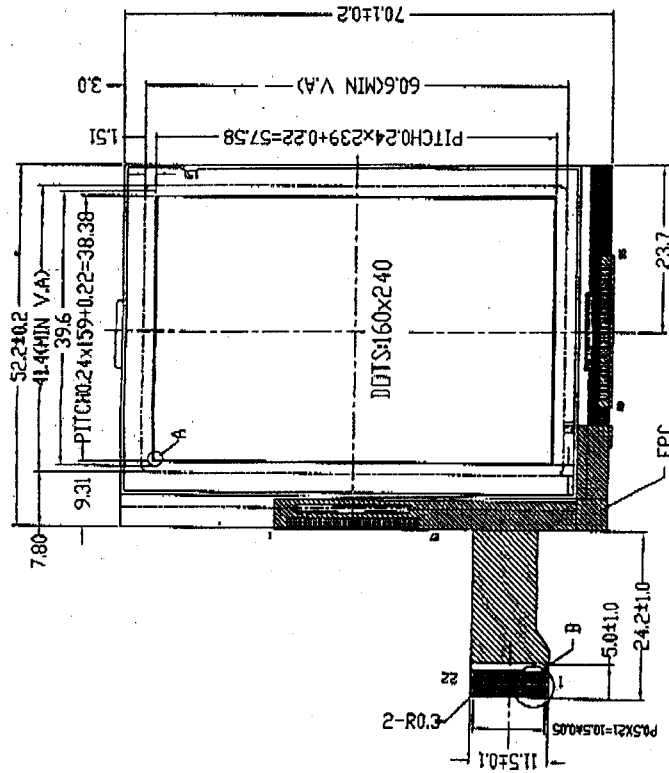

BACK VIEW

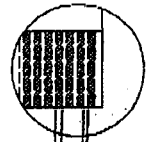
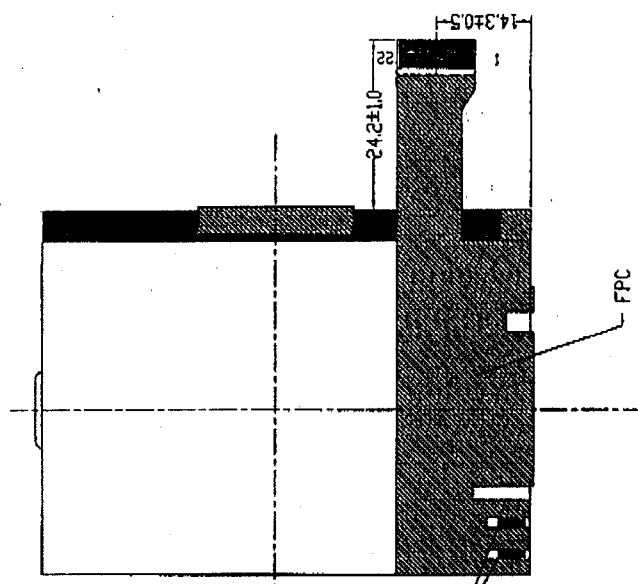

1/0 P00B

| NO. | REV. |
|-----|------|
| 1 | V1 |
| 2 | V2 |
| 3 | V3 |
| 4 | V4 |
| 5 | V5 |
| 6 | V6 |
| 7 | V7 |
| 8 | V8 |
| 9 | V9 |
| 10 | V10 |
| 11 | V11 |
| 12 | V12 |
| 13 | V13 |
| 14 | V14 |
| 15 | V15 |
| 16 | V16 |
| 17 | V17 |
| 18 | V18 |
| 19 | V19 |
| 20 | V20 |
| 21 | V21 |
| 22 | V22 |

NOTES:

1. DISPLAY TYPE: FSTN
2. VIEWING DIRECTION: 6:00
3. POLARIZER MODE: REFLECTIVE/POSITIVE
4. DRIVE METHOD: 1/240 DUTY 1/13 BIAS
5. LCD OPERATING VOLTAGE: 21.5V VDD=2.4~5.5V
6. OPERATING TEMP: -20°C~+70°C
7. STORAGE TEMP: -30°C~+80°C
8. CONNECTOR: FPC
9. DRIVER: S6B0794X01-B0CZ + S6B0796X01-B0CZ
10. WITHOUT BACKLIGHT
11. UNMARKED TOLERANCES: ±0.3mm

TIAN-MA MICROELECTRONICS CO
 6/F., CASTIC Building, Sherman Road, Central, Shenzhen, P.R.

| | | | |
|----------------|-------------------|------------|----------------|
| DRAWN BY: | Y. D. [Signature] | TITLE: | TM160240ACAVG1 |
| CHECKED BY: | [Signature] | DATE: | |
| APPROVED BY: | [Signature] | FIG. NO.: | G-1 |
| CONTROLLED BY: | [Signature] | FIG. NAME: | TM160240ACAVG1 |

3. LCD Module Part Numbering System

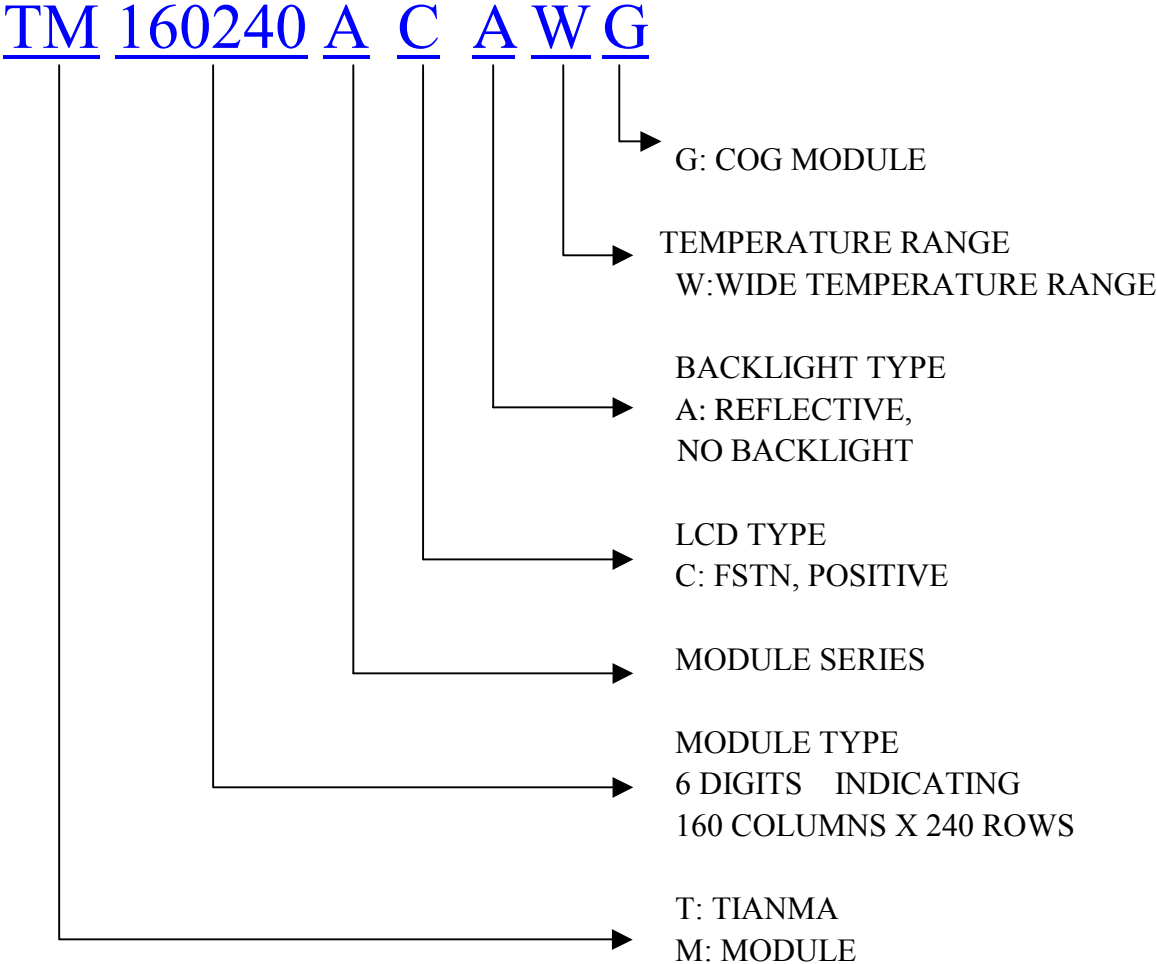

4. Circuit Block Diagram

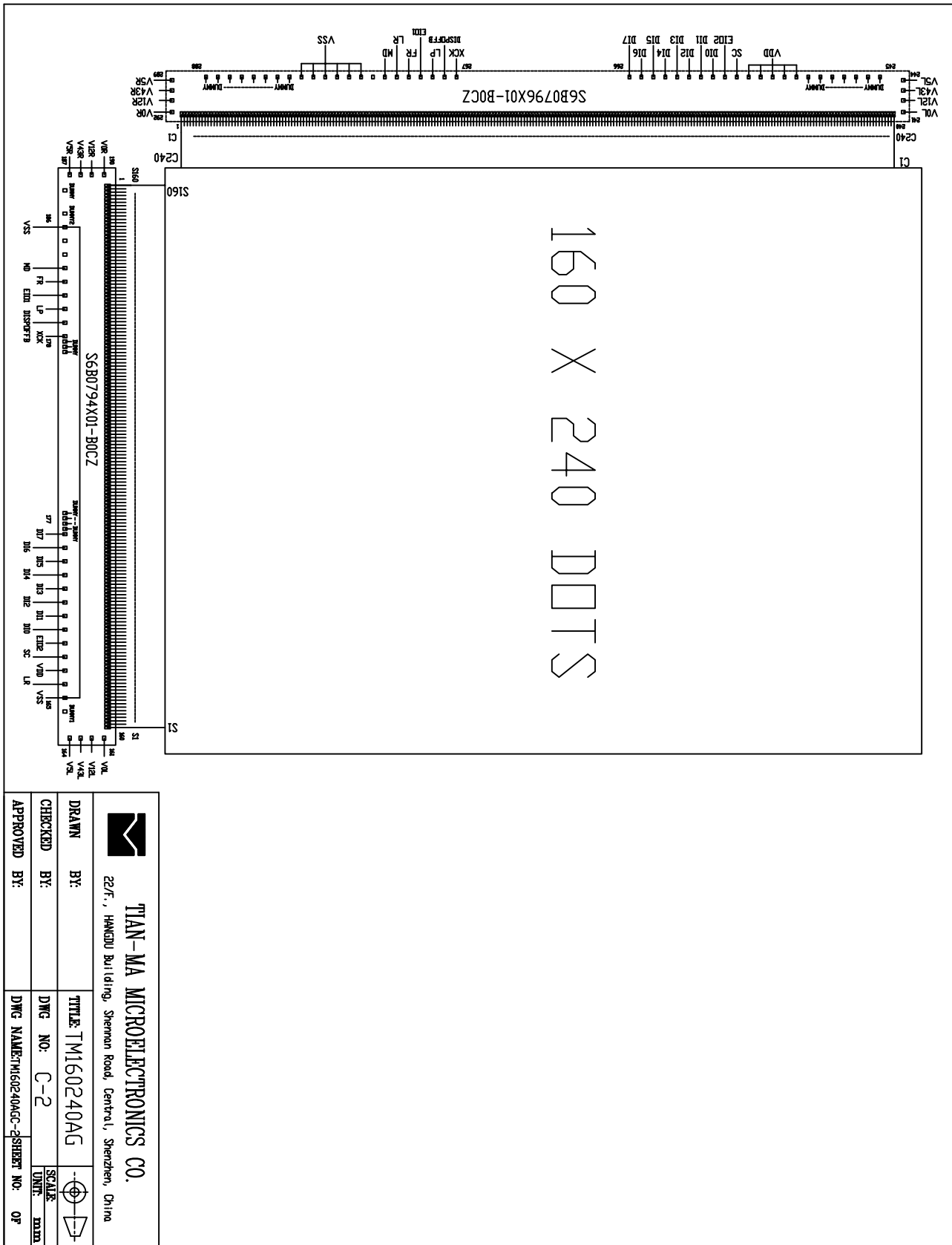

TIAN-MA MICROELECTRONICS CO.
 22/F., HANGOU Building, Shennan Road, Central Shenzhen, China

| | | | |
|--------------|------------------------------------|--------|-----|
| DRAWN BY: | TM160240AG | SCALE: | 1:1 |
| CHECKED BY: | C-2 | UNIT: | mm |
| APPROVED BY: | DWG NAME: TM160240AG-C-2 SHEET NO: | OP | |

5. Absolute Maximum Ratings

| Item | Symbol | Min. | Max. | Unit | Remark |
|-----------------------------|-----------------|------|------|------|--------------------|
| Power Supply Voltage | $V_{DD}-V_{SS}$ | -0.3 | 6.0 | V | |
| LCD Driving Voltage | V_{LCD} | - | 28.0 | | |
| Operating Temperature Range | T_{OP} | -20 | +70 | °C | No Condensation |
| Storage Temperature Range | T_{ST} | -30 | +80 | | |

6. Electrical Specifications and Instruction Code

6.1 Electrical characteristics

| Item | | Symbol | Min. | Typ. | Max. | Unit |
|-------------------------------|------|--------------------------------------|-------------|------|--------------|------|
| Supply Voltage (Logic) | | $V_{DD}-V_{SS}$ | 4.75 | 5.0 | 5.25 | V |
| Supply Voltage (LCD Drive) | | V_{LCD} | - | 21.5 | - | V |
| Input Signal Voltage | High | V_{IH} ($V_{DD}=5.0$) | $0.8V_{DD}$ | - | $V_{DD}+0.3$ | V |
| | Low | V_{IL} ($V_{DD}=5.0$) | 0 | - | $0.2V_{DD}$ | V |
| Supply current (Logic) | | I_{DD} ($V_{DD}-V_{SS}=5.0V$) | - | - | 0.5 | mA |
| Supply current (LCD Drive) | | I_{EE} | - | - | 0.7 | mA |
| | | | | | | |

6.2 Interface Signals

| Pin No. | Symbol | Level | Description |
|---------|--------|-------|---|
| 1 | V5 | - | Bias Voltage For Non-Select (Common Driver) |
| 2 | V2 | - | Bias Voltage For Non-Select(Common Driver) |
| 3 | VEE | 21.5V | Power Supply For LCD |
| 4 | VDD | 5.0V | Power Supply For LOGIC |
| 5 | FRM | H/L | Frame Start Signal |
| 6 | VGND | 0V | GROUND |
| 7 | LOAD | H/L | Latch Pulse of Display Data |
| 8 | VSS | 0V | GROUND |
| 9 | DF | H/L | Switch Signal to Convert LCD Driver |
| 10 | D/OFF | H/L | H: Display On L: Display Off |
| 11 | CP | H/L | Clock Pules for Segment Shift Register |
| 12 | V4 | - | Bias Voltage For Non-Select(Segment Driver) |
| 13 | V3 | - | Bias Voltage For Non-Select(Segment Driver) |
| 14 | D3 | H/L | Input Data Signal |
| 15 | D2 | H/L | Input Data Signal |
| 16 | D1 | H/L | Input Data Signal |
| 17 | D0 | H/L | Input Data Signal |
| 18 | VGND | 0V | GROUND |
| 19 | VSS | 0V | GROUND |
| 20 | NC | - | No connection |
| 21 | VSS | 0V | GROUND |
| 22 | NC | - | No connection |

6.3 Interface Timing Chart

8080 family interface timing

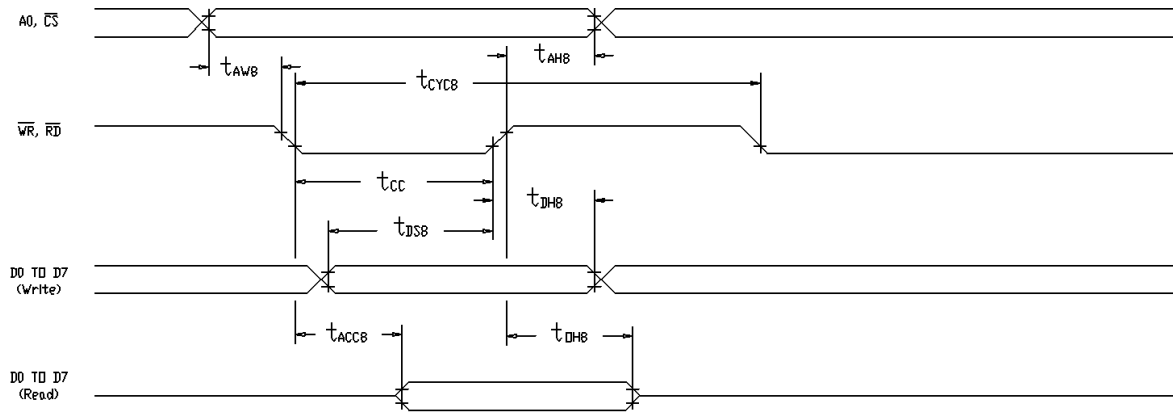

$T_a = -20$ to 75 deg. C

| Signal | Symbol | Parameter | $V_{DD}=4.5$ to $5.5V$ | | $V_{DD}=2.7$ to $5.5V$ | | Unit | Condition |
|--------------------------------|------------|-----------------------------|------------------------|-----|------------------------|-----|------|-----------|
| | | | min | max | min | max | | |
| A0, \overline{CS} | t_{AH8} | Address hold time | 10 | - | 10 | - | ns | CL=100pF |
| | t_{AW8} | Address setup time | 0 | - | 0 | - | ns | |
| $\overline{WR}, \overline{RD}$ | t_{CYC8} | System cycle time | See note. | - | See note. | - | ns | |
| | t_{CC} | Strobe pulsewidth | 120 | - | 150 | - | ns | |
| D0 to D7 | t_{DS8} | Data setup time | 120 | - | 120 | - | ns | |
| | t_{DH8} | Data hold time | 5 | - | 5 | - | ns | |
| | t_{ACC8} | \overline{RD} access time | - | 50 | - | 80 | ns | |
| | t_{OH8} | Output disable time | 10 | 50 | 10 | 55 | ns | |

Note

For memory control and system control commands:

$$t_{CYC8} = 2 t_c + t_{CC} + t_{CEA} + 75 > t_{ACV} + 245$$

for all other commands:

$$t_{CYC8} = 4 t_c + t_{CC} + 30$$

6800 family interface timing

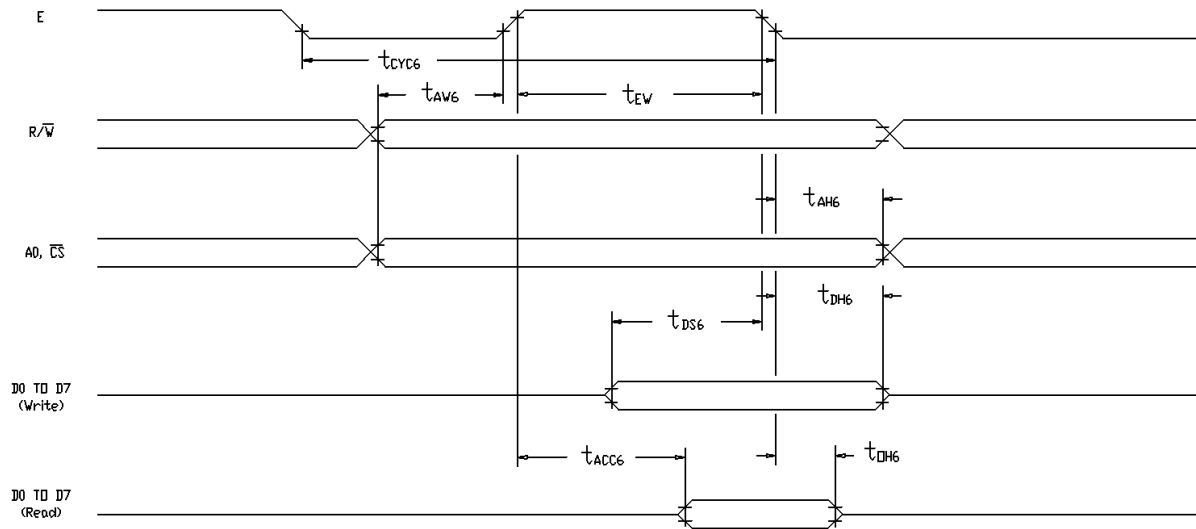

Note

t_{CYC6} indicates the interval during which CS is LOW and E is HIGH

Ta=-20 to 75 deg. C

| Signal | Symbol | Parameter | $V_{DD}=4.5$ to $5.5V$ | | $V_{DD}=2.7$ to $5.5V$ | | Unit | Condition |
|---------------------|------------|---------------------|------------------------|-----|------------------------|-----|------|-----------|
| | | | min | Max | min | max | | |
| A0, \overline{CS} | t_{CYC6} | System cycle time | See note. | - | See note. | - | ns | CL=100pF |
| | t_{AW6} | Address setup time | 0 | - | 10 | - | ns | |
| $\overline{R/W}$ | t_{AH6} | Address hold time | 0 | - | 0 | - | ns | |
| D0 to D7 | t_{DS6} | Data setup time | 100 | - | 120 | - | ns | |
| | t_{DH6} | Data hold time | 0 | - | 0 | - | ns | |
| | t_{OH6} | Output disable time | 10 | 50 | 10 | 75 | ns | |
| | t_{ACC6} | Access time | - | 85 | - | 130 | ns | |
| E | t_{EW} | Enable pulsewidth | 120 | - | 150 | - | ns | |

Note

For memory control and system control commands:

$$t_{CYC8} = 2 t_C + t_{CC} + t_{CEA} + 75 > t_{ACV} + 245$$

for all other commands:

$$t_{CYC8} = 4 t_C + t_{EW} + 30$$

6.4 Instruction Code (Controller: SED1335F)

| Class | Command | Code | | | | | | | | | | | Command description | Number of Bytes | |
|-----------------|-------------|------|----|----|----|----|----|----|----|----|----|----|---------------------|---|----|
| | | RD | WR | A0 | D7 | D6 | D5 | D4 | D3 | D2 | D1 | D0 | | | |
| System control | SYSTEM SET | 1 | 0 | 1 | 0 | 1 | 0 | 0 | 0 | 0 | 0 | 0 | 0 | Initialize device and display | 8 |
| | SLEEP IN | 1 | 0 | 1 | 0 | 1 | 0 | 1 | 0 | 0 | 1 | 1 | 0 | Enter standby mode | 0 |
| Display control | DISP ON/OFF | 1 | 0 | 1 | 0 | 1 | 0 | 1 | 1 | 0 | 0 | D | 0 | Enable and disable display and display flashing | 1 |
| | SCROLL | 1 | 0 | 1 | 0 | 1 | 0 | 0 | 0 | 1 | 0 | 0 | 0 | Set display start address and display regions | 10 |
| | CSRFORM | 1 | 0 | 1 | 0 | 1 | 0 | 1 | 1 | 1 | 0 | 1 | 0 | Set cursor type | 2 |
| | CGRAM ADR | 1 | 0 | 1 | 0 | 1 | 0 | 1 | 1 | 1 | 0 | 0 | 0 | Set start address of character generator RAM | 2 |
| | CSRDIR | 1 | 0 | 1 | 0 | 1 | 0 | 0 | 1 | 1 | CD | CD | 0 | Set direction of cursor movement | 0 |
| | HDOT SCR | 1 | 0 | 1 | 0 | 1 | 0 | 1 | 1 | 0 | 1 | 0 | 0 | Set horizontal scroll position | 1 |
| | OVLAY | 1 | 0 | 1 | 0 | 1 | 0 | 1 | 1 | 0 | 1 | 1 | 0 | Set display overlay format | 1 |
| Drawing control | CSRW | 1 | 0 | 1 | 0 | 1 | 0 | 0 | 0 | 1 | 1 | 0 | 0 | Set cursor address | 2 |
| | CSRR | 0 | 1 | 1 | 0 | 1 | 0 | 0 | 0 | 1 | 1 | 1 | 0 | Read cursor address | 2 |
| Memory control | MWRITE | 1 | 0 | 1 | 0 | 1 | 0 | 0 | 0 | 0 | 1 | 0 | 0 | Write to display memory | - |
| | MREAD | 0 | 1 | 1 | 0 | 1 | 0 | 0 | 0 | 0 | 1 | 1 | 0 | Read from display memory | - |

Notes

- In general, the internal registers of the SED1335F/1336F are modified as each command parameter is input. However, the microprocessor does not have to set all the parameters of a command and may send a new command before all parameters have been input. The internal registers for the parameters that have been input will have been changed but the remaining parameter registers are unchanged.
2-byte parameters (where two bytes are treated as 1 data item) are handled as follows:
 - CSRW, CSRR: Each byte is processed individually. The microprocessor may read or write just the low byte of the cursor address.
 - SYSTEM SET, SCROLL, CGRAM ADR: Both parameter bytes are processed together. If the command is changed after half of the parameters has been input, the single byte is ignored.
- APL and APH are 2-byte parameters, but are treated as two 1-byte parameters.

7. Optical Characteristics

7.1 Optical Characteristics

Ta=25°C

| Item | Symbol | Condition | Min. | Typ. | Max. | Unit | |
|----------------|------------|--|--|------|------|------|-----|
| Viewing Angle | θ_x | $C_r \geq 2$ | $\theta_y = 0^\circ$ | -30 | -- | 20 | Deg |
| | θ_y | | | | | | |
| Contrast Ratio | C_r | $\theta_x = 0^\circ$ $\theta_y = 0^\circ$ | 3.0 | - | - | | |
| Response Time | Turn on | T_{on} | $\theta_x = 0^\circ$ $\theta_y = 0^\circ$ | - | - | 350 | Ms |
| | Turn off | T_{off} | | | | - | |

7.2 Definition of Optical Characteristics

7.2.1 Definition of Viewing Angle

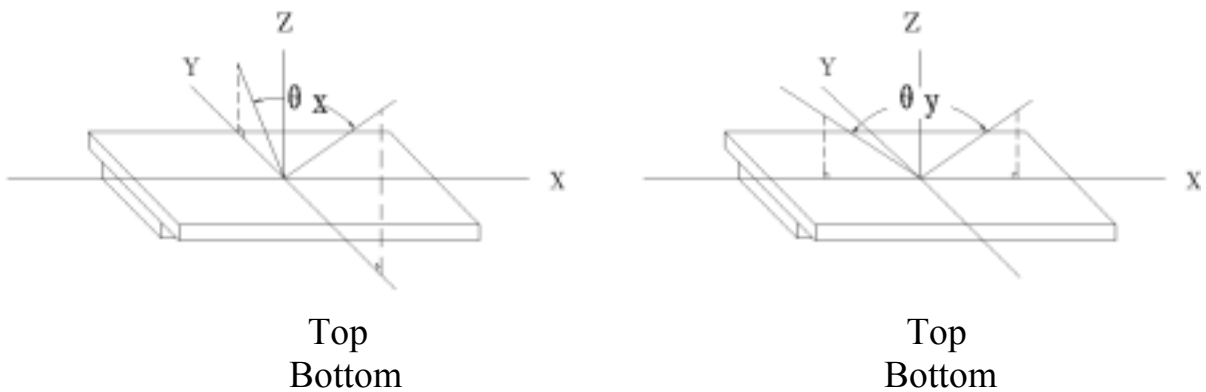

7.2.2 Definition of Contrast Ratio

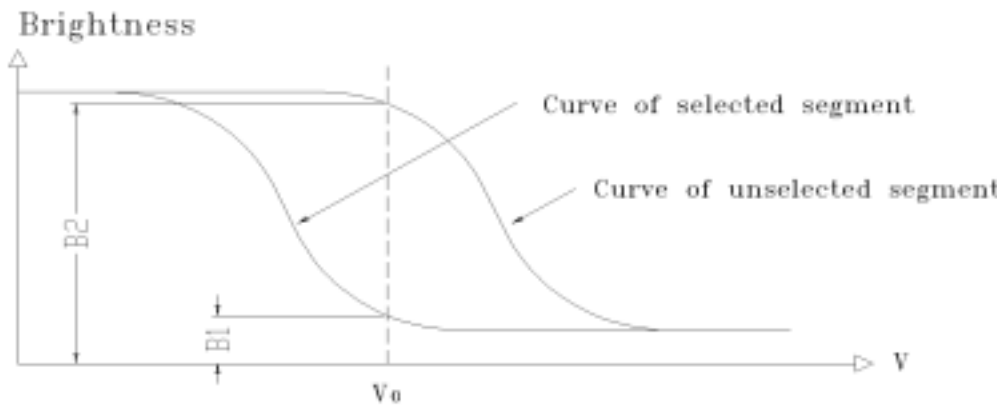

$$\text{Contrast Ratio} = B2/B1 = \frac{\text{unselected state brightness}}{\text{selected state brightness}}$$

Measuring Conditions:

- 1) Ambient Temperature: 25°C ;
- 2) Frame frequency: 64Hz

7.2.3 Definition of Response time

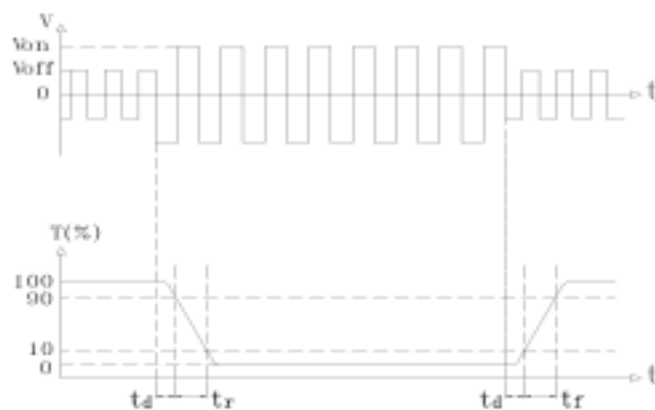

Turn on time: $t_{on} = t_d + t_r$ Turn off time: $t_{off} = t_d + t_r$

Measuring Condition:

- 1) Operating Voltage: 21.5V ;
- 2) Frame frequency: 64Hz

8. Reliability

8.1 Content of Reliability Test

Ta=25°C

| No. | Test Item | Content of Test | Test condition |
|-----|------------------------------------|--|---|
| 1 | High Temperature Storage | Endurance test applying the high storage temperature for a long time | 80°C 240H Restore 4H at 25°C |
| 2 | Low Temperature Storage | Endurance test applying the low storage temperature for a long time | -30°C 240H Restore 4H at 25°C |
| 3 | High Temperature Operation | Endurance test applying the electric stress (voltage & current) and the thermal stress to the element for a long time | 70°C 240H |
| 4 | Low Temperature Operation | Endurance test applying the electric stress under low temperature for a long time | -20°C 240H |
| 5 | High Temperature /Humidity Storage | Endurance test applying the high temperature and high humidity storage for a long time | 60°C 95%RH 240H Restore 4H at 25°C |
| 6 | Temperature Cycle | Endurance test applying the low and high temperature cycle $\begin{array}{ccccccc} -30^{\circ}\text{C} & \longleftrightarrow & 25^{\circ}\text{C} & \longleftrightarrow & 80^{\circ}\text{C} & \longleftrightarrow & 25^{\circ}\text{C} \\ 30\text{min} & & 5\text{min} & & 30\text{min} & & 5\text{min} \\ \leftarrow & & & & & & \rightarrow \\ & & & & \text{1 cycle} & & \end{array}$ | -30°C/80°C 10 cycles Restore 4H at 25°C |
| 7 | Vibration Test (package state) | Endurance test applying the vibration during transportation | 10Hz~500Hz, 100m/s ² , 120min |
| 8 | Shock Test (package state) | Endurance test applying the shock during transportation | Half- sine wave, 300m/s ² , 18ms |
| 9 | Atmospheric Pressure Test | Endurance test applying the atmospheric pressure during transportation by air | 25kPa 16H Restore 2H |

8.2 Failure Judgment Criterion

| Criterion Item | Test Item No. | | | | | | | | | Failure Judgement Criterion |
|--------------------------|--|---|---|---|---|---|---|---|---|-------------------------------------|
| | 1 | 2 | 3 | 4 | 5 | 6 | 7 | 8 | 9 | |
| Basic Specification | √ | √ | √ | √ | √ | √ | √ | √ | √ | Out of the basic Specification |
| Electrical Specification | √ | √ | √ | √ | √ | | | | | Out of the electrical specification |
| Mechanical Specification | | | | | | | √ | √ | | Out of the mechanical specification |
| Optical Characteristic | √ | √ | √ | √ | √ | √ | | | √ | Out of the optical specification |
| Note | For test item refer to 8.1 | | | | | | | | | |
| Remark | Basic specification = Optical specification + Mechanical specification | | | | | | | | | |

9. QUALITY LEVEL

| Examination or Test | At $T_a=25^{\circ}\text{C}$ (unless otherwise stated) | Inspection | | | | |
|---|--|----------------|------|------|----|------------------------------|
| | | Min. | Max. | Unit | IL | AQL |
| External Visual Inspection | Under normal illumination and eyesight condition, the distance between eyes and LCD is 25cm. | See Appendix A | | | II | Major 1.0 Minor 2.5 |
| Display Defects | Under normal illumination and eyesight condition, display on inspection. | See Appendix B | | | II | Major 1.0 Minor 2.5 |
| Note: Major defects: Open segment or common, Short, Serious damages, Leakage Miner defects: Others Sampling standard conforms to GB2828 | | | | | | |

10. Precautions for Use of LCD Modules

10.1 Handling Precautions

10.1.1 The display panel is made of glass. Do not subject it to a mechanical shock by dropping it from a high place, etc.

10.1.2 If the display panel is damaged and the liquid crystal substance inside it leaks out, be sure not to get any in your mouth, if the substance comes into contact with your skin or clothes, promptly wash it off using soap and water.

10.1.3 Do not apply excessive force to the display surface or the adjoining areas since this may cause the color tone to vary.

10.1.4 The polarizer covering the display surface of the LCD module is soft and easily scratched. Handle this polarizer carefully.

10.1.5 If the display surface is contaminated, breathe on the surface and gently wipe it with a soft dry cloth. If still not completely clear, moisten cloth with one of the following solvents:

- Isopropyl alcohol
- Ethyl alcohol

Solvents other than those mentioned above may damage the polarizer. Especially, do not use the following:

- Water
- Ketone
- Aromatic solvents

10.1.6 Do not attempt to disassemble the LCD Module.

10.1.7 If the logic circuit power is off, do not apply the input signals.

10.1.8 To prevent destruction of the elements by static electricity, be careful to maintain an optimum work environment.

- a. Be sure to ground the body when handling the LCD Modules.
- b. Tools required for assembly, such as soldering irons, must be properly ground.
- c. To reduce the amount of static electricity generated, do not conduct assembly and other work under dry conditions.
- d. The LCD Module is coated with a film to protect the display surface. Be care when peeling off this protective film since static electricity may be generated.

10.2 Storage precautions

10.2.1 When storing the LCD modules, avoid exposure to direct sunlight or to the light of fluorescent lamps.

10.2.2 The LCD modules should be stored under the storage temperature range. If the LCD modules will be stored for a long time, the recommend condition is:

Temperature : $0^{\circ}\text{C} \sim 40^{\circ}\text{C}$

Relatively humidity: $\leq 80\%$

10.2.3 The LCD modules should be stored in the room without acid, alkali and harmful gas.

10.3 The LCD modules should be no falling and violent shocking during transportation, and also should avoid excessive press, water, damp and sunshine.

Appendix A

Inspection items and criteria for appearance defects

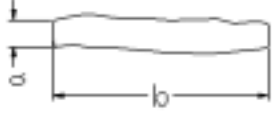
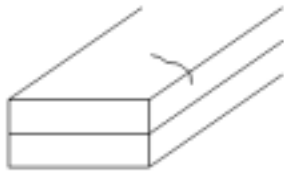
| Items | Contents | Criteria | | | |
|---------------------------------|---|---------------------------------|--|------------------------------|--|
| Leakage | | Not permitted | | | |
| Rainbow | | According to the limit specimen | | | |
| Polarizer | Wrong polarizer attachment | Not permitted | | | |
| | Bubble between polarizer and glass | Not counted | Max. 3 defects allowed | | |
| | | $\phi < 0.3\text{mm}$ | $0.3\text{mm} \leq \phi \leq 0.5\text{mm}$ | | |
| | Scratches of polarizer | According to the limit specimen | | | |
| Black spot (in viewing area) |  | Not counted | Max. 3 spots allowed | Max. 3 spots (lines) allowed | |
| | | $X < 0.2\text{mm}$ | $0.2\text{mm} \leq X \leq 0.5\text{mm}$ | | |
| | | $X = (a+b)/2$ | | | |
| Black line (in viewing area) |  | Not counted | Max. 3 lines allowed | | |
| | | $a < 0.02\text{mm}$ | $0.02\text{mm} \leq a \leq 0.05\text{mm}$ $b \leq 2.0\text{mm}$ | | |
| Progressive cracks |  | Not permitted | | | |

Appendix A

Inspection item and criteria for appearance defects (continued)

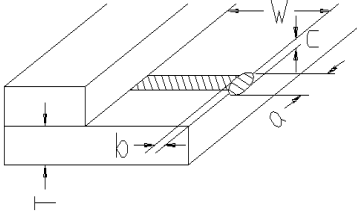
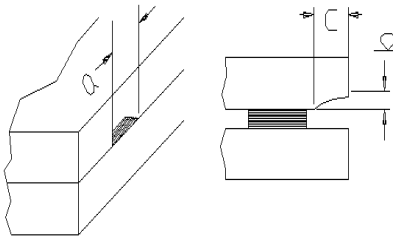
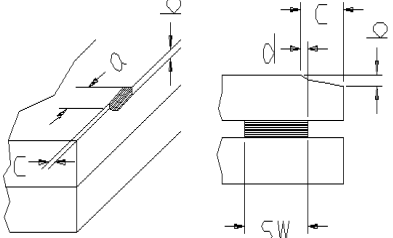
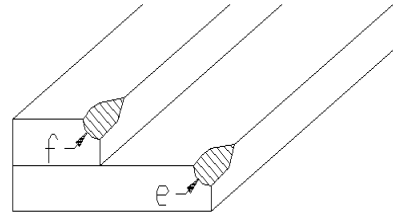
| Items | Contents | Criteria | | | | |
|---|--|---------------|-----------------------|-----------------------|-----------------------|-----------------------|
| Glass Cracks | Cracks on pads  | a | b | c | Max. 2 Cracks allowed | Max. 5 cracks allowed |
| | $\leq 3\text{mm}$ | $\leq W/5$ | $\leq T/2$ | | | |
| | $\leq 2\text{mm}$ | $\leq W/5$ | $T/2 < C < T$ | | | |
| | Cracks on contact side  | a | b | Max. 2 cracks allowed | | |
| | $\leq 3\text{mm}$ | $\leq T/2$ | | | | |
| | $\leq 2\text{mm}$ | $T/2 < b < T$ | | | | |
| | C shall be not reach the seal area | | | | | |
| | Cracks on non-contact side  | a | b | Max. 2 cracks allowed | | |
| | $\leq 3\text{mm}$ | $\leq T/2$ | | | | |
| | $\leq 2\text{mm}$ | $T/2 < b < T$ | | | | |
| $C \leq 0.5\text{mm}$ | | | | | | |
| $d \leq SW/3$ | | | | | | |
| Corner cracks  | $e < 2.0\text{mm}^2$ $f < 2.0\text{mm}^2$ | | Max. 3 cracks allowed | | | |

Appendix B

Inspection items and criteria for display defects

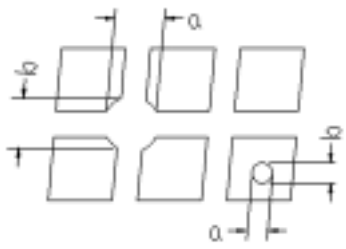
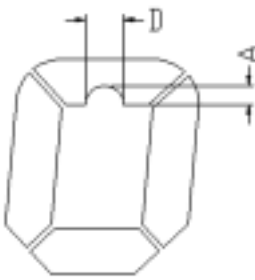
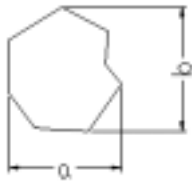
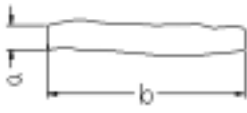
| Items | Contents | Criteria | | |
|---------------------------------------|---|--|--|-----------------------------|
| Open segment or open common | | Not permitted | | |
| Short | | Not permitted | | |
| Wrong viewing angle | | Not permitted | | |
| Contrast ratio uneven | | According to the limit specimen | | |
| Crosstalk | | According to the limit specimen | | |
| Pin holes and cracks in segment (DOT) |  | Not counted | Max.3 dots allowed | Max.3 dots allowed |
| | | $X < 0.1\text{mm}$ | $0.1\text{mm} \leq X \leq 0.2\text{mm}$ | |
| | | $X = (a+b)/2$ | | |
| |  | Not counted | Max.2 dots allowed | |
| $A < 0.1\text{mm}$ | | $0.1\text{mm} \leq A \leq 0.2\text{mm}$ $D < 0.25\text{mm}$ | | |
| Black spot (in viewing area) |  | Not counted | Max.3 spots allowed | Max.3 spots (lines) allowed |
| | | $X < 0.1\text{mm}$ | $0.1\text{mm} \leq X \leq 0.2\text{mm}$ | |
| | | $X = (a+b)/2$ | | |
| Black line (in viewing area) |  | Not counted | Max.3 lines allowed | |
| | | $a < 0.02\text{mm}$ | $0.02\text{mm} \leq a \leq 0.05\text{mm}$ $b \leq 0.5\text{mm}$ | |

Appendix B

Inspection items and criteria for display defects (continued)

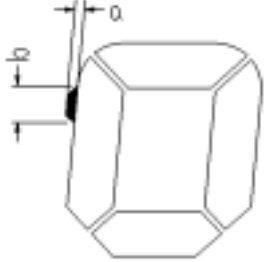
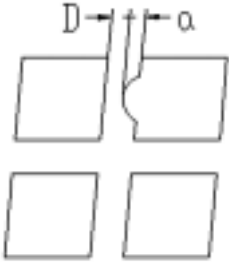
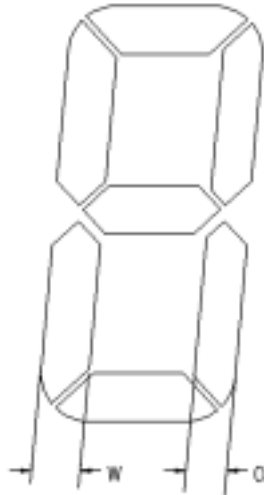
| Items | Content | Criteria | | | |
|---------------------------|---|---|------------------------|-----------------------|--|
| Transformation of segment |  | Not counted | Max. 2 defects allowed | Max.3 defects allowed | |
| | $x < 0.1 \text{ mm}$ | $0.1 \text{ mm} \leq x \leq 0.2 \text{ mm}$ | | | |
| | $x = (a+b)/2$ | | | | |
| |  | Not counted | Max. 1 defects allowed | | |
| | $a < 0.1 \text{ mm}$ | $0.1 \text{ mm} \leq a \leq 0.2 \text{ mm}$ $D > 0$ | | | |
| |  | Max.2 defects allowed $0.8W \leq a \leq 1.2W$ $a = \text{measured value of width}$ $W = \text{nominal value of width}$ | | | |