

**PLEASE CHECK WWW.MOLEX.COM FOR LATEST PART INFORMATION**

**Part Number:** [0877590414](#)  
**Status:** **Active**  
**Overview:** milligrd  
**Description:** 2.00mm (.079") Pitch Milli-Grid™ Header, Surface Mount, Vertical, 4 Circuits, 0.38µm (15µ") Gold (Au) Selective Plating, without Press-fit Plastic Pegs, Lead-free

**Documents:**

[3D Model](#) [Product Specification PS-87761-100 \(PDF\)](#)  
[Drawing \(PDF\)](#) [RoHS Certificate of Compliance \(PDF\)](#)

**Agency Certification**

UL E29179

**General**

Product Family PCB Headers  
 Series [87759](#)  
 Application Board-to-Board  
 Overview [milligrd](#)  
 Product Name Milli-Grid™

**Physical**

Breakaway Yes  
 Circuits (Loaded) 4  
 Circuits (maximum) 4  
 Color - Resin Black  
 Durability (mating cycles max) 100  
 First Mate / Last Break No  
 Flammability 94V-0  
 Glow-Wire Compliant No  
 Guide to Mating Part No  
 Keying to Mating Part None  
 Lock to Mating Part None  
 Mated Height (in) 0.150 In  
 Mated Height (mm) 3.80 mm  
 Material - Metal Phosphor Bronze  
 Material - Plating Mating Gold  
 Material - Plating Termination Tin  
 Material - Resin Nylon  
 Number of Rows 2  
 Orientation Vertical  
 PCB Locator No  
 PCB Retention None  
 Packaging Type Tray  
 Pitch - Mating Interface (in) 0.079 In  
 Pitch - Mating Interface (mm) 2.00 mm  
 Pitch - Term. Interface (in) 0.079 In  
 Pitch - Term. Interface (mm) 2.00 mm  
 Plating min: Mating (µin) 15  
 Plating min: Mating (µm) 0.38  
 Polarized to Mating Part No  
 Polarized to PCB No  
 Shrouded No  
 Stackable No  
 Temperature Range - Operating -55°C to +105°C  
 Termination Interface: Style Surface Mount

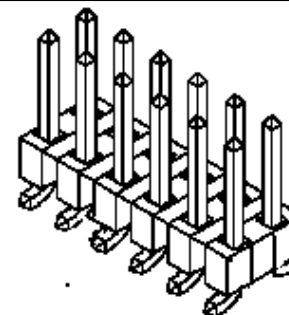

Series

*image - Reference only*

**EU RoHS**

**ELV and RoHS Compliant**  
**REACH SVHC Contains SVHC: No**  
**Halogen-Free Status**

**China RoHS**



**Not Halogen-Free**

**Need more information on product environmental compliance?**

Email [productcompliance@molex.com](mailto:productcompliance@molex.com)  
 For a multiple part number RoHS Certificate of Compliance, [click here](#)

Please visit the [Contact Us](#) section for any non-product compliance questions.

**Search Parts in this Series**

[87759Series](#)

**Mates With**

[79107](#) Milli-Grid™ Receptacle, Vertical, Through Hole. [79108](#) Milli-Grid™ Flex-to-Board, Vertical Receptacle. Milli-Grid™ Receptacle, Surface Mount. [79109](#). [87381](#)

**Electrical**

|                               |      |
|-------------------------------|------|
| Current - Maximum per Contact | 2A   |
| Voltage - Maximum             | 125V |

**Solder Process Data**

|  |                           |
|--|---------------------------|
| Duration at Max. Process Temperature (seconds) | 10                        |
| Lead-free Process Capability                   | Reflow Capable (SMT only) |
| Max. Cycles at Max. Process Temperature        | 3                         |
| Process Temperature max. C                     | 260                       |

**Material Info****Reference - Drawing Numbers**

|                         |              |
|-------------------------|--------------|
| Packaging Specification | PK-89990-475 |
| Product Specification   | PS-87761-100 |
| Sales Drawing           | SD-87759-117 |

This document was generated on 05/25/2010

**PLEASE CHECK [WWW.MOLEX.COM](http://WWW.MOLEX.COM) FOR LATEST PART INFORMATION**

F

E

D

C

B

A

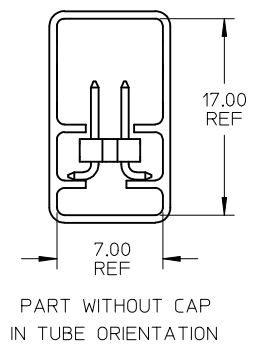
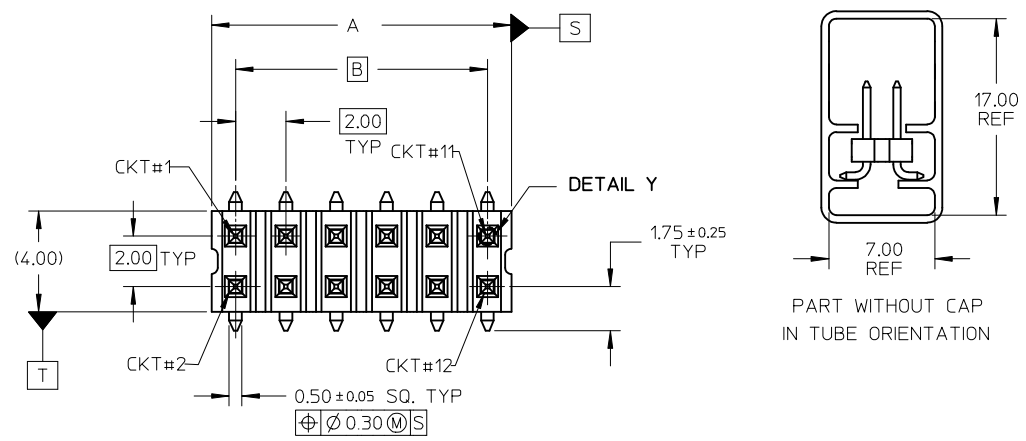

- NOTE:
- MATERIAL:  
HSG & CAP - NYLON, GLASS FILLED  
UL 94V-0, COLOUR BLACK  
  
PIN - 0.50 SQ PHOSPHOR BRONZE
  - PLATING:  
0.38um MIN GOLD PLATE AT CONTACT AREA,  
TIN PLATE AT SOLDER AREA,  
BOTH OVER NICKEL UNDERPLATE
  - PIN PUSHOUT FORCE: 1KG MIN IN EITHER DIRECTION
  - PRODUCT SPEC PS-87761-100 APPLIES.
  - BEND DEPRESSION IS ACCEPTABLE SO LONG AS IT DOES NOT AFFECT THE OVERALL COPLANARITY OF TAIL.
  - COPLANARITY IS TO BE MEASURED BY RESTING THE SOLDER TAIL ON A FLAT SURFACE.
  - CAP TO BE LOCATED AS CENTRAL OF PART AS POSSIBLE  
TOP SURFACE OF CAP TO BE FLAT FOR THE PURPOSE OF PICK & PLACE BY VACUUM SUCTION NOZZLE.
  - FOR ILLUSTRATION PURPOSES, 12CKT IS SHOWN.
  - CKT 4 & 6 IS CUT FROM CKT 8 & 12 RESPECTIVELY  
ROUGH EDGES ARE EXPECTED ALONG THE CUTTING EDGES.
  - PART TO BE PACKED IN TRAY ONLY.
  - TUBE LENGTH IS 560MM REF STANDARD.

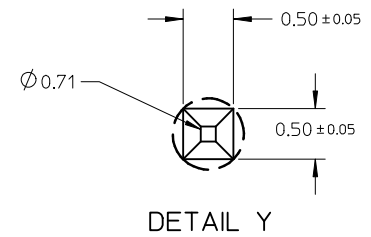
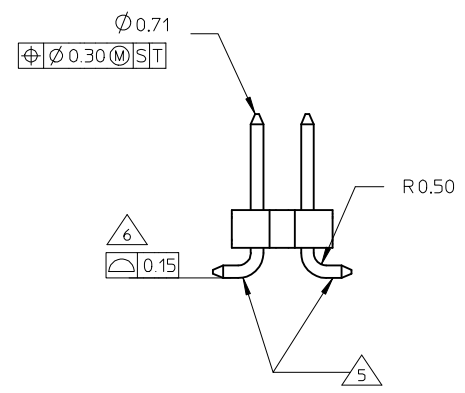
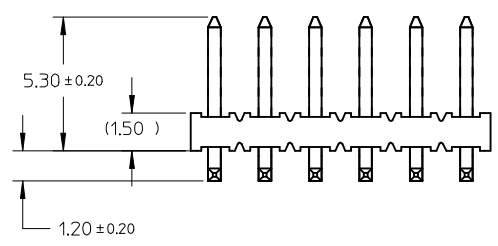

|   |                               |   |            |                            |              |                              |                        |  |
|---|-------------------------------|---|------------|----------------------------|--------------|------------------------------|------------------------|--|
| ADD. OPTION<br>EC NO: S2009-0510<br>DRWN:ATSEE 2009/01/23<br>CHKD:SKANG 2009/02/09<br>APPR:MLONG 2009/02/17 | QUALITY SYMBOLS<br>▽=0<br>◻=0 | GENERAL TOLERANCES (UNLESS SPECIFIED)   |            | DIMENSION STYLE<br>MM ONLY | SCALE<br>NTS | DESIGN UNITS<br>METRIC       | THIRD ANGLE PROJECTION |  |
|   |                               | mm  | INCH       | DRAWN BY                   | DATE         | TITLE                        |                        |  |
|   |                               | 4 PLACES ± ---  | ± ---      | KSEE                       | 2003/12/12   | CUSTOM HEADER                |                        |  |
|   |                               | 3 PLACES ± ---  | ± ---      | CHECKED BY                 | DATE         | MGRID, 2MM DUAL ROW HDR. SMT |                        |  |
| 2 PLACES ± 0.2  | ± ---                         | KCL ING   | 2004/01/12 | APPROVED BY                |              |                              | MOLEX INCORPORATED     |  |
| 1 PLACE ± ---   | ± ---                         | SKTOH   | 2004/01/12 | DATE                       |              |                              |                        |  |
| ANGULAR ± 3 °   |                               | MATERIAL NO.  |            | DOCUMENT NO.               |              |                              | SHEET NO.              |  |
| DRAFT WHERE APPLICABLE MUST REMAIN WITHIN DIMENSIONS  |                               | SEE TABLE   |            | SD-87759-117               |              |                              | 1 OF 6                 |  |
| SIZE  |                               | THIS DRAWING CONTAINS INFORMATION THAT IS PROPRIETARY TO MOLEX INCORPORATED AND SHOULD NOT BE USED WITHOUT WRITTEN PERMISSION |            |                            |              |                              |                        |  |

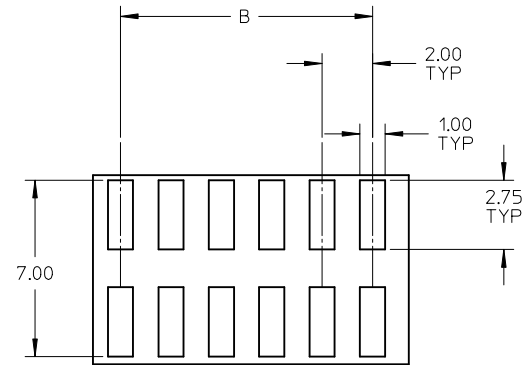
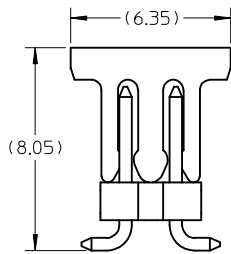
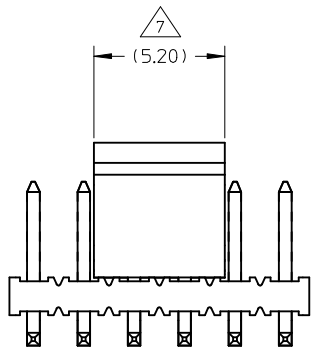

RECOMMENDED SOLDER PAD LAYOUT

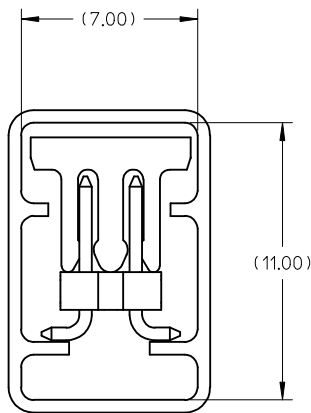
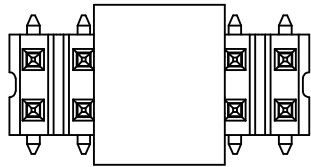

|   |                               |   |  |                                      |   |                              |                        |  |  |
|---|-------------------------------|---|--|--------------------------------------|---|------------------------------|------------------------|--|--|
| ADD. OPTION<br>EC NO: S2009-0510<br>DRWN:ATSEE 2009/01/23<br>CHKD:SKANG 2009/02/09<br>APPR:MLONG 2009/02/17 | QUALITY SYMBOLS<br>▽=0<br>◻=0 | GENERAL TOLERANCES (UNLESS SPECIFIED)   |  | DIMENSION STYLE<br>MM ONLY           | SCALE<br>NTS  | DESIGN UNITS<br>METRIC       | THIRD ANGLE PROJECTION |  |  |
|   |                               | 4 PLACES ± --- ± ---<br>3 PLACES ± --- ± ---<br>2 PLACES ± 0.2 ± ---<br>1 PLACE ± --- ± --- | mm INCH  | DRAWN BY DATE<br>KSEE 2003/12/12     | TITLE<br>CUSTOM HEADER<br>MGRID, 2MM DUAL ROW HDR.<br>SMT |                              |                        |  |  |
|   |                               | ANGULAR ± 3 °   |  | CHECKED BY DATE<br>KCLING 2004/01/12 | MOLEX INCORPORATED  |                              |                        |  |  |
|   | B2                            | DESCRIPTION<br>REV  | DRAFT WHERE APPLICABLE<br>MUST REMAIN<br>WITHIN DIMENSIONS | APPROVED BY DATE<br>SKTOH 2004/01/12 | MATERIAL NO.<br>SEE TABLE                                 | DOCUMENT NO.<br>SD-87759-117 | SHEET NO.<br>2 OF 6    |  |  |

EMBOSSED CARRIER TAPE TYPE "A"

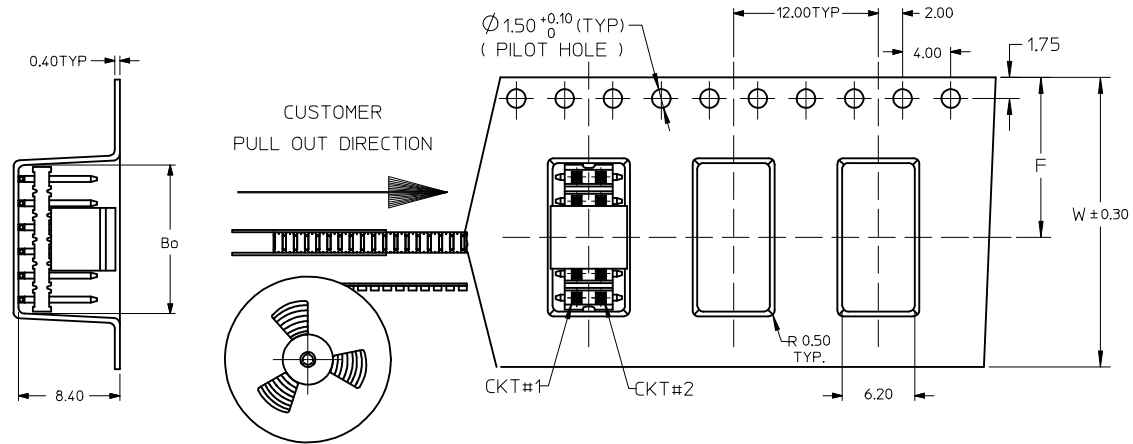

NOTES:

12. LEADER AND TRAILER TAPE

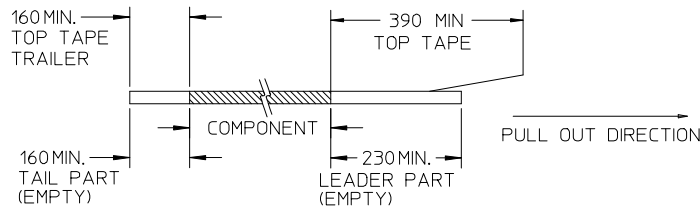

13. PEELING OFF FORCE OF THE TOP TAPE: 20-80gf.  
(PEELING DIRECTION AS SHOWN IN FOLLOWING FIGURE)

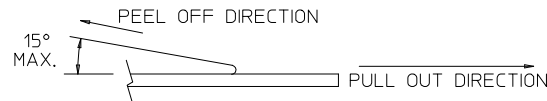

14. PACKAGING STANDARD IS AS PER EIA-481.

15. TAPE & REEL QUANTITY = 750 PCS/REEL

16. THE TAPE IS TREATED FOR ANTI-STATIC

|   |  |   |  |   |  |                     |  |
|---|--|---|--|---|--|---------------------|--|
| ADD. OPTION<br>EC NO: S2009-0510<br>DRWN:ATSEE 2009/01/23<br>CHKD:SKANG 2009/02/09<br>APPR:MLONG 2009/02/17<br>REV B2 | QUALITY SYMBOLS<br>▽=0<br>▽=0                              | GENERAL TOLERANCES (UNLESS SPECIFIED)<br>mm INCH<br>4 PLACES ± --- ± ---<br>3 PLACES ± --- ± ---<br>2 PLACES ± 0.2 ± ---<br>1 PLACE ± --- ± ---<br>ANGULAR ± 3° | DIMENSION STYLE<br>MM ONLY<br>DRAWN BY: KSEE<br>CHECKED BY: KCLING<br>APPROVED BY: SKTOH<br>DATE: 2003/12/12<br>DATE: 2004/01/12<br>DATE: 2004/01/12 | SCALE<br>NTS<br>DESIGN UNITS<br>METRIC<br>THIRD ANGLE PROJECTION  | TITLE<br>CUSTOM HEADER<br>MGRID, 2MM DUAL ROW HDR.<br>SMT<br>MOLEX INCORPORATED<br>DOCUMENT NO. SD-87759-117 | SHEET NO.<br>3 OF 6 |  |
|   | DRAFT WHERE APPLICABLE<br>MUST REMAIN<br>WITHIN DIMENSIONS |   | SEE TABLE  | THIS DRAWING CONTAINS INFORMATION THAT IS PROPRIETARY TO MOLEX INCORPORATED AND SHOULD NOT BE USED WITHOUT WRITTEN PERMISSION |  |                     |  |
|   |  |   |  |   |  |                     |  |
|   |  |   |  |   |  |                     |  |

EMBOSSED CARRIER TAPE TYPE "B"

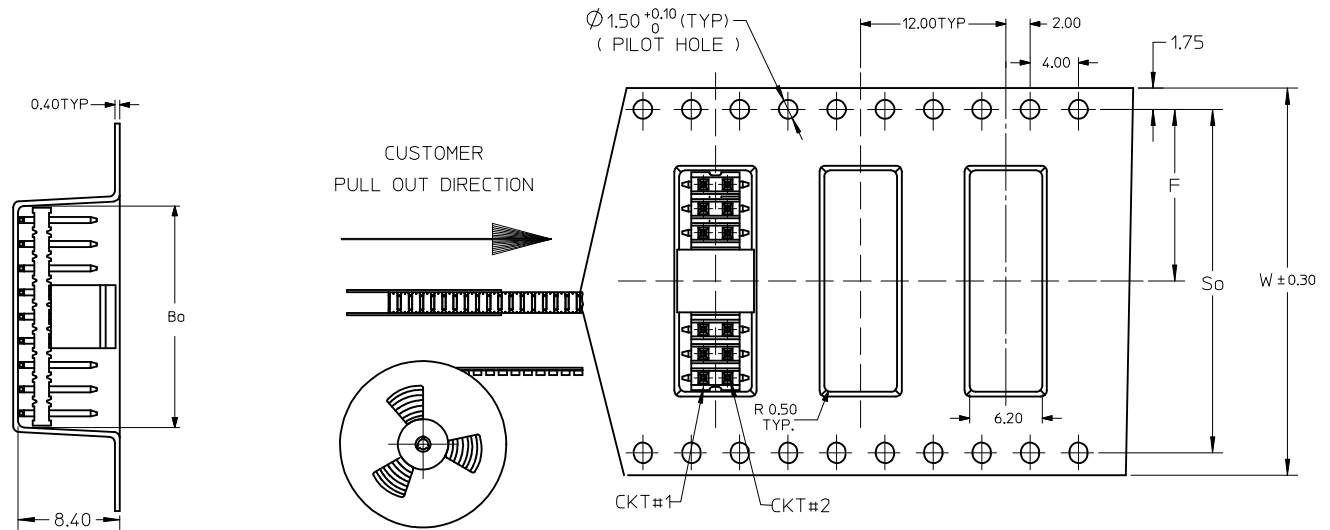

|   |                               |  |  |  |   |
|---|-------------------------------|--|--|--|---|
| ADD. OPTION<br>EC NO: S2009-0510<br>DRWN:ATSEE 2009/01/23<br>CHKD:SKANG 2009/02/09<br>APPR:MLONG 2009/02/17 | QUALITY SYMBOLS<br>▽=0<br>◻=0 | GENERAL TOLERANCES (UNLESS SPECIFIED)<br>mm INCH<br>4 PLACES ± --- ± ---<br>3 PLACES ± --- ± ---<br>2 PLACES ± 0.2 ± ---<br>1 PLACE ± --- ± ---<br>ANGULAR ± 3 ° | DIMENSION STYLE<br>MM ONLY<br>DRAWN BY DATE<br>KSEE 2003/12/12<br>CHECKED BY DATE<br>KCLING 2004/01/12<br>APPROVED BY DATE<br>SKTOH 2004/01/12 | SCALE<br>NTS<br>DESIGN UNITS<br>METRIC<br>THIRD ANGLE PROJECTION | TITLE<br>CUSTOM HEADER<br>MGRID, 2MM DUAL ROW HDR.<br>SMT |
|   | DESCRIPTION<br>B2             | DRAFT WHERE APPLICABLE<br>MUST REMAIN<br>WITHIN DIMENSIONS   | MATERIAL NO.<br>SEE TABLE  | MOLEX INCORPORATED<br>DOCUMENT NO.<br>SD-87759-117               | SHEET NO.<br>4 OF 6                                       |
|   | SIZE<br>A3                    | THIS DRAWING CONTAINS INFORMATION THAT IS PROPRIETARY TO MOLEX INCORPORATED AND SHOULD NOT BE USED WITHOUT WRITTEN PERMISSION                                    |  |  |   |
|   |                               |  |  |  |   |

THIS TYPE OF CARRIER IS FOR CKT SIZE 8 AND BELOW.

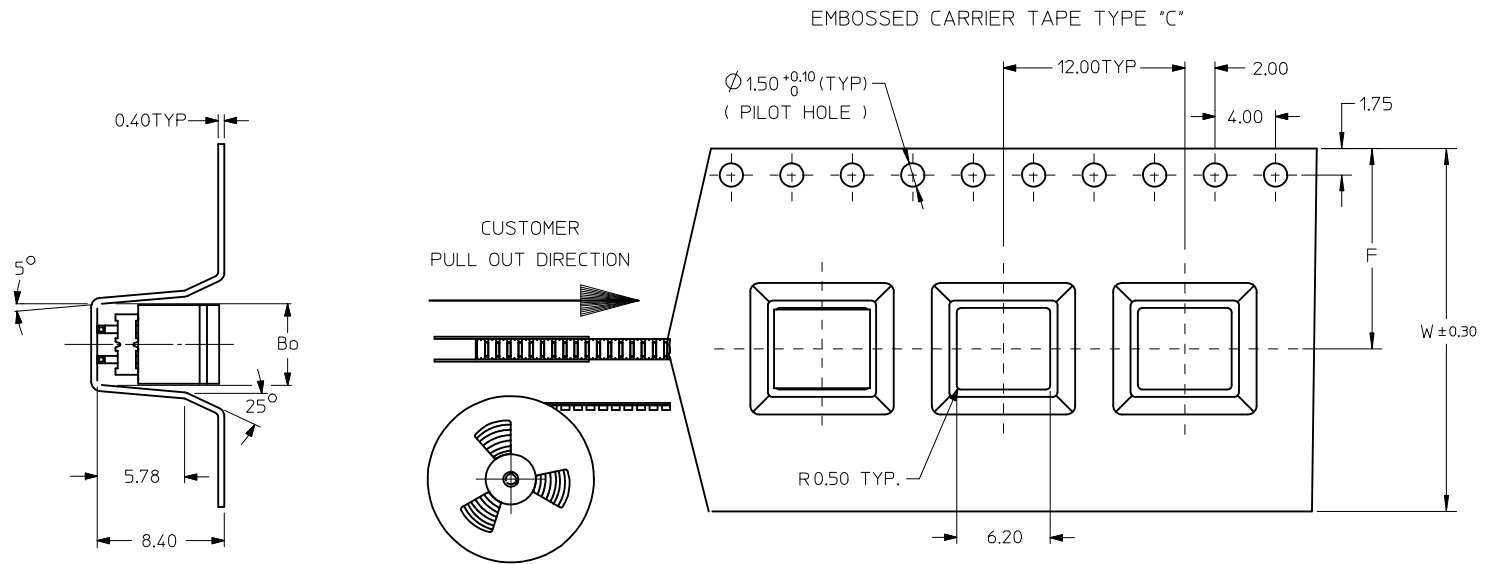

|  |                    |                               |                                       |            |   |                     |   |                        |                            |  |
|--|--------------------|-------------------------------|---------------------------------------|------------|---|---------------------|---|------------------------|----------------------------|--|
| <b>ADD. OPTION</b><br>EC NO: S2009-0510<br>DRWN:ATSEE 2009/01/23<br>CHKD:SKANG 2009/02/09<br>APPR:MLONG 2009/02/17 | DESCRIPTION<br>REV | QUALITY SYMBOLS<br>▽=0<br>◻=0 | GENERAL TOLERANCES (UNLESS SPECIFIED) |            | DIMENSION STYLE<br><b>MM ONLY</b>   | SCALE<br><b>NTS</b> | DESIGN UNITS<br><b>METRIC</b>   | THIRD ANGLE PROJECTION |                            |  |
|  |                    |                               | mm                                    | INCH       | DRAWN BY  | DATE                | TITLE   |                        |                            |  |
|  |                    | 4 PLACES                      | ± ---                                 | ± ---      | KSEE  | 2003/12/12          | <b>CUSTOM HEADER<br/>         MGRID, 2MM DUAL ROW HDR.<br/>         SMT</b> |                        |                            |  |
|  |                    | 3 PLACES                      | ± ---                                 | ± ---      | CHECKED BY  | DATE                |   |                        |                            |  |
|  | ± 0.2              | ± ---                         | KCLING                                | 2004/01/12 | <b>MOLEX INCORPORATED</b>   |                     |   |                        |                            |  |
| 2 PLACES   | ± ---              | ± ---                         | APPROVED BY                           | DATE       |   |                     |   |                        |                            |  |
| 1 PLACE  | ± ---              | ± ---                         | SKTOH                                 | 2004/01/12 | MATERIAL NO.      DOCUMENT NO.  |                     |   |                        |                            |  |
| ANGULAR ± 3 °  |                    |                               | MATERIAL NO.                          |            |   |                     |   |                        | <b>SD-87759-117</b>        |  |
| DRAFT WHERE APPLICABLE MUST REMAIN WITHIN DIMENSIONS   |                    |                               | SIZE                                  |            | THIS DRAWING CONTAINS INFORMATION THAT IS PROPRIETARY TO MOLEX INCORPORATED AND SHOULD NOT BE USED WITHOUT WRITTEN PERMISSION |                     |   |                        |                            |  |
|  |                    |                               | A3                                    |            |   |                     |   |                        | SHEET NO.<br><b>5 OF 6</b> |  |

|   | 10                                      | 9                            | 8                                      | 7        | 6         | 5     | 4     | 3     | 2     | 1     |       |               |
|---|---|------------------------------|--|----------|-----------|-------|-------|-------|-------|-------|-------|---------------|
|   | PART NUMBER WITHOUT CAP IN TUBE         | PART NUMBER WITH CAP IN TUBE | PART NUMBER WITH CAP IN TAPE AND REEL. | CKT SIZE | VOID CKTS | A     | B     | Bo    | F     | So    | W     | EMBOSSED TYPE |
| F | 87759-0414 $\triangle_9 \triangle_{10}$ | 87759-0464                   | 87759-0474                             | 4        | --        | NA    | 2.00  | 5.40  | 11.50 | -     | 24.00 | C             |
|   | 87759-0614 $\triangle_9$                | 87759-0664                   | 87759-0674                             | 6        | --        | NA    | 4.00  | 7.20  | 11.50 | -     | 24.00 | C             |
|   | 87759-0814                              | 87759-0864                   | 87759-0874                             | 8        | --        | 7.90  | 6.00  | 8.20  | 11.50 | -     | 24.00 | C             |
|   | 87759-1014                              | 87759-1064                   | 87759-1074                             | 10       | --        | 9.90  | 8.00  | 10.20 | 11.50 | -     | 24.00 | A             |
|   | 87759-1002 $\triangle_A$                | 87759-1003 $\triangle_A$     | 87759-1004 $\triangle_A$               | 10       | 10        | 9.90  | 8.00  | 10.20 | 11.50 | -     | 24.00 | A             |
|   | 87759-1214                              | 87759-1264                   | 87759-1274                             | 12       | --        | 11.90 | 10.00 | 12.20 | 11.50 | -     | 24.00 | A             |
| E | 87759-1414                              | 87759-1464                   | 87759-1474                             | 14       | --        | 13.90 | 12.00 | 14.20 | 11.50 | -     | 24.00 | A             |
|   | 87759-1614                              | 87759-1664                   | 87759-1674                             | 16       | --        | 15.90 | 14.00 | 16.20 | 14.20 | 28.40 | 32.00 | B             |
|   | 87759-1814                              | 87759-1864                   | 87759-1874                             | 18       | --        | 17.90 | 16.00 | 18.20 | 14.20 | 28.40 | 32.00 | B             |
|   | 87759-2014                              | 87759-2064                   | 87759-2074                             | 20       | --        | 19.90 | 18.00 | 20.20 | 14.20 | 28.40 | 32.00 | B             |
|   | 87759-2214                              | 87759-2264                   | 87759-2274                             | 22       | --        | 21.90 | 20.00 | 22.20 | 20.20 | 40.40 | 44.00 | B             |
| D | 87759-2414                              | 87759-2464                   | 87759-2474                             | 24       | --        | 23.90 | 22.00 | 24.20 | 20.20 | 40.40 | 44.00 | B             |
|   | 87759-2614                              | 87759-2664                   | 87759-2674                             | 26       | --        | 25.90 | 24.00 | 26.20 | 20.20 | 40.40 | 44.00 | B             |
|   | 87759-2814                              | 87759-2864                   | 87759-2874                             | 28       | --        | 27.90 | 26.00 | 28.20 | 20.20 | 40.40 | 44.00 | B             |
|   | 87759-3014                              | 87759-3064                   | 87759-3074                             | 30       | --        | 29.90 | 28.00 | 30.20 | 20.20 | 40.40 | 44.00 | B             |
|   | 87759-3214                              | 87759-3264                   | 87759-3274                             | 32       | --        | 31.90 | 30.00 | 32.20 | 20.20 | 40.40 | 44.00 | B             |
|   | 87759-3414                              | 87759-3464                   | 87759-3474                             | 34       | --        | 33.90 | 32.00 | 34.20 | 26.20 | 52.40 | 56.00 | B             |
|   | 87759-3614                              | 87759-3664                   | 87759-3674                             | 36       | --        | 35.90 | 34.00 | 36.20 | 26.20 | 52.40 | 56.00 | B             |
| C | 87759-3814                              | 87759-3864                   | 87759-3874                             | 38       | --        | 37.90 | 36.00 | 38.20 | 26.20 | 52.40 | 56.00 | B             |
|   | 87759-4014                              | 87759-4064                   | 87759-4074                             | 40       | --        | 39.90 | 38.00 | 40.20 | 26.20 | 52.40 | 56.00 | B             |
|   | 87759-4214                              | 87759-4264                   | 87759-4274                             | 42       | --        | 41.90 | 40.00 | 42.20 | 26.20 | 52.40 | 56.00 | B             |
|   | 87759-4414                              | 87759-4464                   | 87759-4474                             | 44       | --        | 43.90 | 42.00 | 44.20 | 26.20 | 52.40 | 56.00 | B             |
|   | 87759-4614                              | 87759-4664                   | 87759-4674                             | 46       | --        | 45.90 | 44.00 | 46.20 | 26.20 | 52.40 | 56.00 | B             |
|   | 87759-4814                              | 87759-4864                   | 87759-4874                             | 48       | --        | 47.90 | 46.00 | 48.20 | 26.20 | 52.40 | 56.00 | B             |
| B | 87759-5014                              | 87759-5064                   | 87759-5074                             | 50       | --        | 49.90 | 48.00 | 50.20 | 34.20 | 68.40 | 72.00 | B             |

NOTES:

$\triangle_A$  VOIDED PIN CKT#10 FOR PART#87759-1002

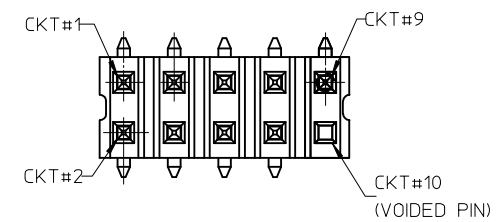

| <b>ADD. OPTION</b><br>EC NO: S2009-0510<br>DRWN:ATSEE 2009/01/23<br>CHKD:SKANG 2009/02/09<br>APPR:MLONG 2009/02/17<br><b>B2</b> | <b>QUALITY SYMBOLS</b><br>$\nabla=0$<br>$\triangle=0$ | <b>GENERAL TOLERANCES (UNLESS SPECIFIED)</b><br><table border="1"> <tr> <th></th> <th>mm</th> <th>INCH</th> </tr> <tr> <td>4 PLACES</td> <td><math>\pm</math> ---</td> <td><math>\pm</math> ---</td> </tr> <tr> <td>3 PLACES</td> <td><math>\pm</math> ---</td> <td><math>\pm</math> ---</td> </tr> <tr> <td>2 PLACES</td> <td><math>\pm</math> 0.2</td> <td><math>\pm</math> ---</td> </tr> <tr> <td>1 PLACE</td> <td><math>\pm</math> ---</td> <td><math>\pm</math> ---</td> </tr> </table> |          | mm        | INCH      | 4 PLACES | $\pm$ --- | $\pm$ --- | 3 PLACES | $\pm$ --- | $\pm$ --- | 2 PLACES | $\pm$ 0.2 | $\pm$ --- | 1 PLACE | $\pm$ --- | $\pm$ --- | <b>DIMENSION STYLE</b><br><b>MM ONLY</b><br>DRAWN BY: KSEE DATE: 2003/12/12<br>CHECKED BY: KCLING DATE: 2004/01/12<br>APPROVED BY: SKTOH DATE: 2004/01/12<br>MATERIAL NO. SKTOH | <b>SCALE</b><br>NTS<br><b>DESIGN UNITS</b><br>METRIC<br><b>THIRD ANGLE PROJECTION</b> | <b>TITLE</b><br>CUSTOM HEADER<br>MGRID, 2MM DUAL ROW HDR.<br>SMT<br><b>MOLEX INCORPORATED</b><br>DOCUMENT NO. SD-87759-117 | SHEET NO.<br>6 OF 6 |
|---|---|---|----------|-----------|-----------|----------|-----------|-----------|----------|-----------|-----------|----------|-----------|-----------|---------|-----------|-----------|---|---|--|---------------------|
|   |   |   |          | mm        | INCH      |          |           |           |          |           |           |          |           |           |         |           |           |   |   |  |                     |
|   |   |   | 4 PLACES | $\pm$ --- | $\pm$ --- |          |           |           |          |           |           |          |           |           |         |           |           |   |   |  |                     |
|   |   |   | 3 PLACES | $\pm$ --- | $\pm$ --- |          |           |           |          |           |           |          |           |           |         |           |           |   |   |  |                     |
| 2 PLACES  | $\pm$ 0.2   | $\pm$ ---   |          |           |           |          |           |           |          |           |           |          |           |           |         |           |           |   |   |  |                     |
| 1 PLACE   | $\pm$ ---   | $\pm$ ---   |          |           |           |          |           |           |          |           |           |          |           |           |         |           |           |   |   |  |                     |
| <b>DRAFT WHERE APPLICABLE MUST REMAIN WITHIN DIMENSIONS</b>   | <b>SEE TABLE</b>                                      | THIS DRAWING CONTAINS INFORMATION THAT IS PROPRIETARY TO MOLEX INCORPORATED AND SHOULD NOT BE USED WITHOUT WRITTEN PERMISSION   |          |           |           |          |           |           |          |           |           |          |           |           |         |           |           |   |   |  |                     |
|   |   |   |          |           |           |          |           |           |          |           |           |          |           |           |         |           |           |   |   |  |                     |
|   |   |   |          |           |           |          |           |           |          |           |           |          |           |           |         |           |           |   |   |  |                     |