

LINEAR INTEGRATED CIRCUIT

PRELIMINARY DATA

FM-IF RADIO SYSTEM

- HIGH LIMITING SENSITIVITY
- HIGH AMR
- HIGH RECOVERED AUDIO
- GOOD CAPTURE RATIO
- LOW DISTORTION
- MUTING CAPABILITY

The TDA 1200 is a silicon monolithic integrated circuit in a 16-lead dual in-line plastic package. It provides a complete subsystem for amplification of FM signals.

The functions incorporated are:

- FM amplification and detection
- interchannel controlled muting
- AFC and delayed AGC for FM tuner
- switching of stereo decoder
- driving of a field strength meter

The TDA 1200 can be used for FM-IF amplifier application in HI-FI, car-radios and communication receivers.

ABSOLUTE MAXIMUM RATINGS

V_s	Supply voltage	16 V
I_o	Output current (from pin 15)	2 mA
P_{tot}	Total power dissipation at $T_{amb} \leq 70^\circ\text{C}$	500 mW
T_{stg}	Storage temperature	-55 to 150 °C
T_{op}	Operating temperature	-25 to 70 °C

ORDERING NUMBER: TDA 1200

MECHANICAL DATA

Dimensions in mm

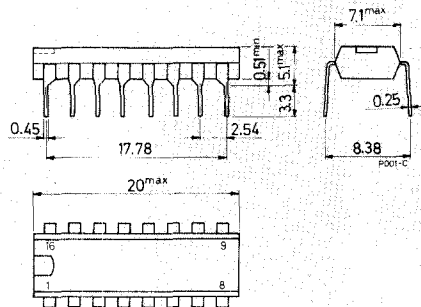

TDA 1200

ELECTRICAL CHARACTERISTICS (continued)

Parameter	Test conditions	Min. Typ. Max.	Unit
DYNAMIC CHARACTERISTICS			
$V_{i(\text{threshold})}$ Input limiting voltage (-3 dB) at pin 1	$f_0 = 10.7 \text{ MHz}$ $f_m = 1 \text{ kHz}$ $\Delta f = \pm 25 \text{ kHz}$	12	μV
V_o Recovered audio voltage (pin 6)	$V_i \geq 50 \mu\text{V}$ $f_0 = 10.7 \text{ MHz}$ $f_m = 1 \text{ kHz}$ $\Delta f = \pm 25 \text{ kHz}$	140	mV
d Distortion	$V_i \geq 1 \text{ mV}$ $f_0 = 10.7 \text{ MHz}$	0.5	%
$\frac{S+N}{N}$ Signal and noise to noise ratio	$f_m = 1 \text{ kHz}$ $\Delta f = \pm 75 \text{ kHz}$	60	dB
AMR Amplitude modulation rejection	$V_i \geq 1 \text{ mV}$ $f_0 = 10.7 \text{ MHz}$ $f_m = 1 \text{ kHz}$ $\Delta f = \pm 25 \text{ kHz}$ $m = 0.3$	40	dB
V_i Input voltage for delayed AGC action(pin 1)		10	mV
$\frac{\Delta V_{15}}{\Delta V_i}$ AGC control slope	$V_i \geq 10 \text{ mV}$ $f_0 = 10.7 \text{ MHz}$	40	dB
$\frac{\Delta I_7}{\delta f}$ AFC control slope		1	$\frac{\mu\text{A}}{\text{kHz}}$
$\frac{\Delta V_{13}}{\Delta V_i}$ Field strength meter output slope		42	dB
V_{13} Field strength meter output sensitivity	$V_i = 1 \text{ mV}$ $f_0 = 10.7 \text{ MHz}$	1.7	V

TDA 1200

Typical relative recovered audio and noise output versus input voltage

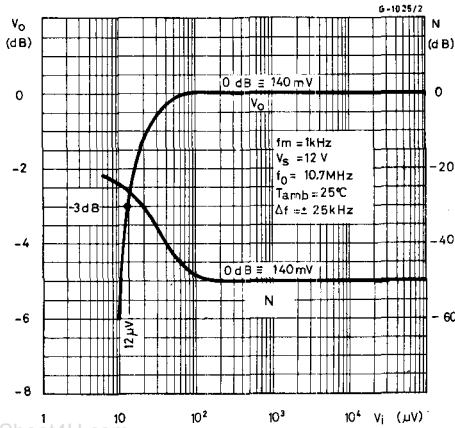

Typical capture ratio versus input voltage

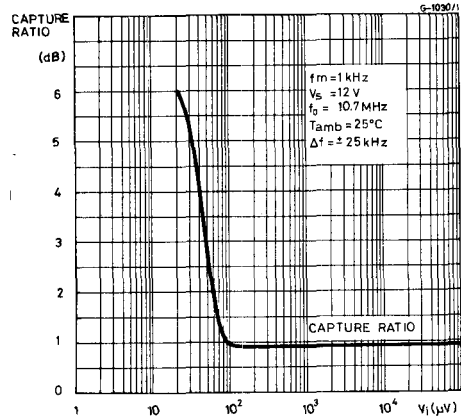

www.DataSheet4U.com

Typical AGC (V_{15}) and field strength meter output (V_{13}) versus input signal

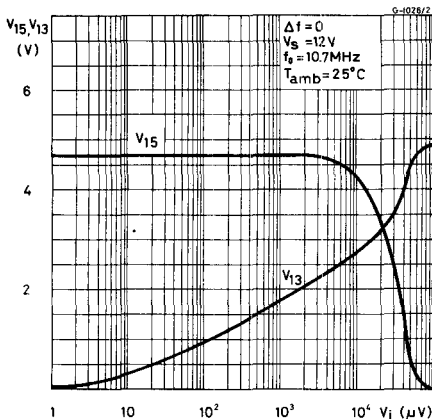

Typical AFC output current versus change-in tuning frequency

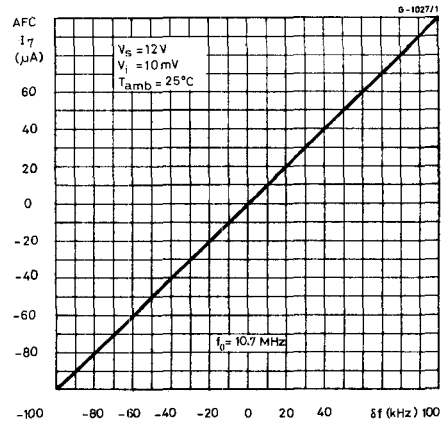

Typical amplitude modulation rejection versus input signal

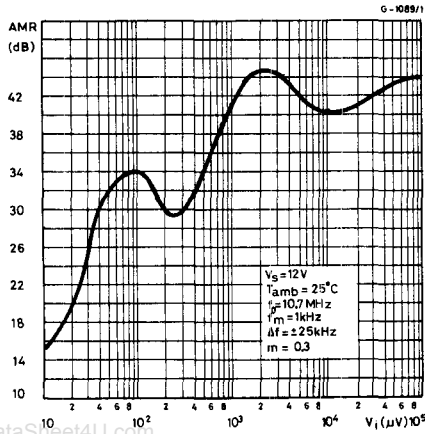

Typical AMR (relative to the value of f₀ = 10.7 MHz) versus change-in tuning frequency

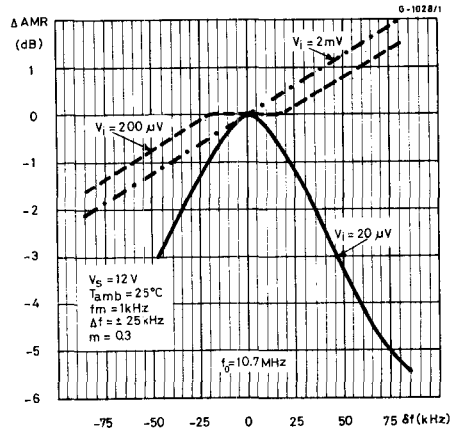

APPLICATIONS

PC board and component layout of the circuit on next page (1:1 scale).

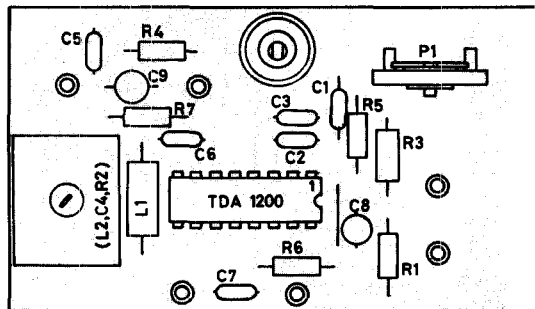

CS-0024

TDA 1200

Typical application circuit

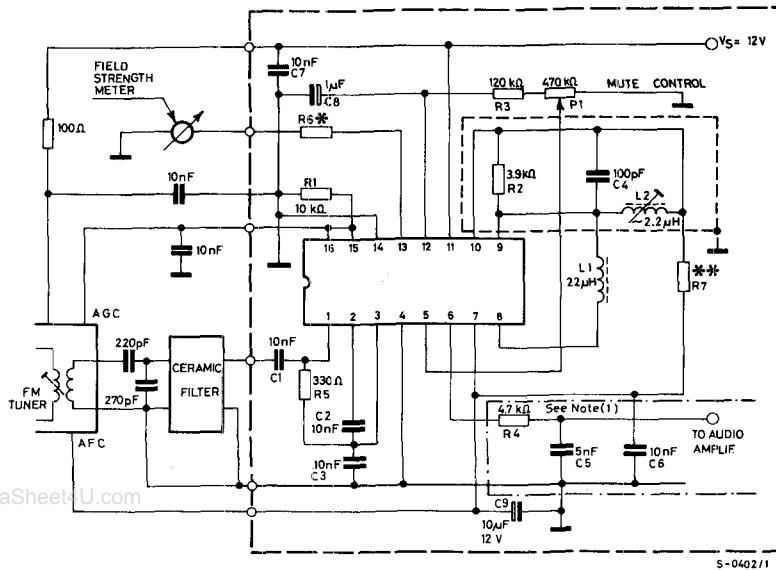

S-0402/1

NOTES: (1) When V_s is less than 12 V, a resistor $R_8 = 12\text{ k}\Omega$ must be connected between audio output and ground, and the integrator capacitor C_5 must be changed to 10 nF, as follows:

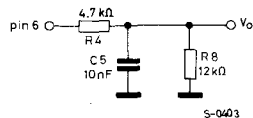

S-0403

* Dependent on field strength meter sensitivity.

** Dependent on the tuner's AFC circuit.