

# LAN-PAC SERIES

DC/DC CONVERTERS - 9V OUTPUT

## FEATURES

- IEEE 802.3 standards
- Meets FCC Sec 15, Sub Part J, A&B
- Input/Output isolated to IEEE 802.3 standards
- PC mountable, low profile
- Continuous short circuit protected, self recovering (2E12R9, 2E12R9E and 2E5R9)
- No derating to 71°C
- Wide input voltage range
- 100% burned-in and triple tested
- 3 year warranty

## GENERAL DESCRIPTION

The Lan-Pac Series of DC/DC converters is designed to provide power and isolation for local area network (LAN) transceiver chips.

The Lan-Pac Series covers both the Cheapernet and Ethernet LAN (IEEE 802.3 10base 5 and 10base 2 standards) approach. The use of a compact and inexpensive DC/DC converter as the power source for these new transceiver chips allows conversion of the normal buss power to the isolated power required.

The series operates from inputs of 5 and 12 VDC for Cheapernet with input/output isolation of 500 VDC and wide input models of 10.2 - 15.75 VDC for Ethernet, with 2500 VDC isolation.

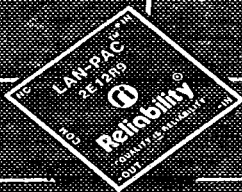

**GENERAL ELECTRICAL SPECIFICATIONS**

(Specifications at Nominal Input and 25°C)

PARAMETER	LIMIT	CONDITIONS
<b>2VP, 2VI, 2SP &amp; 2PC Series</b>		
Input Voltage Range	4.75 - 5.25VDC 11.4 - 12.6VDC	5V Devices 12V Devices
Input Filter	Filter Capacitor	All Device Types
Input/Output Isolation Voltage	500 VDC (Min.)	All 2VP, 2VI & 2SP Device Types
Resistance	3000 VDC (Min.) 10 <sup>3</sup> megohms (Min.)	2PC5R9 Only
Output Voltage Accuracy	± 5%	Nom. Line at Full Load (2VP, 2VI & 2SP Device Types) Overline, Load (2PC5R9)
Load Regulation	See Graph*	
Output Noise/Ripple	100 mV, P-P (Max.)	20 HZ-20MHZ Bandwidth
Minimum Load Required	10% of Full Load	All Units Except 2PC5R9
Line Regulation	See Graph*	
Short Circuit Protection	Momentary	All Units
Operating Temperature	-25° to 71°C	
Derating	None	To 71°C
Storage Temperature	-55°C to + 125°C	
FCC Sec 15, Sub Part J	Yes	Class B Radiated, Class A Conducted
<b>2E Series</b>		
Input Voltage Range	10.2 - 15.75	All Devices
Input Filter	Filter Capacitor	All Devices
Input/Output Isolation Voltage	2500 VDC (Min.)	All Device Types
Resistance	10 <sup>3</sup> megohms (Min.)	
Output Voltage Accuracy	± 5%	Nom. Line at Full Load
Load Regulation	50 mV	Nom. Line, NL to FL
Line Regulation	300 mV	Full input range, FL
Output Noise/Ripple	100 mV, P-P (Max.)	20 HZ-20MHZ Bandwidth
Short Circuit Protection	Current Fold-Back	All Units
Duration	Continuous	
Switching Frequency	30 KHZ	Typical
Operating Temperature	-25° to + 71°C	
Derating	None	To 71°C
Storage Temperature	-55°C to + 125°C	
External Heatsink	Recommended for still air environments	
Case	UL94V-0	
Encapsulant	UL94H-B	
Heat Dissipation	45°C Case Rise	High Line, Full Load
FCC Sec 15, Sub Part J	Yes	Class B Radiated, Class A Conducted

\*All 2VP, 2VI, 2SP Device Types.

# SELECTION GUIDE STANDARD PRODUCTS

DEVICE TYPE	INPUT VOLTAGE VDC	INPUT CURRENT A (MAX)	OUTPUT VOLTAGE VDC	OUTPUT CURRENT ma (MAX)	PACKAGE	APPLICATION
2VP5U9	5	.600	-9	250	2VP	Cheapernet
2VI5U9	5	.600	-9	250	2VI	Cheapernet
2PC5R9	5	.550	-9	200	2PC	Cheapernet
2SP5U9	5	.600	-9	250	2SP	Cheapernet
2VP5U9LN	5	.550	-9	250	2VP	Cheapernet
2E5R9	5	.900	-9	250	2E	Ethernet
2VP12U9	12	.250	-9	250	2VP	Cheapernet
2E12R9	12	.350	-9	250	2E	Ethernet
2E12R9E	12	.400	-9	250	2E	Ethernet
2SP12U9	12	.250	-9	250	2SP	Cheapernet

## MECHANICAL DIMENSIONS AND PIN CONNECTIONS

2E

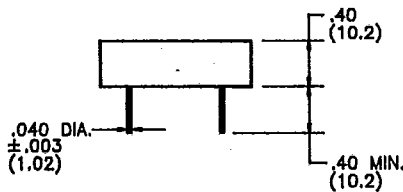

2E5R9 & 2E12R9

PIN	PIN CONNECTIONS
1	+ INPUT
2	- INPUT
3	NO CONNECTION
4	OUTPUT COMMON
5	- OUTPUT

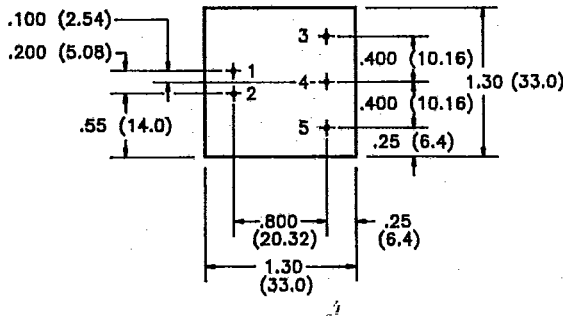

2E12R9E

PIN	PIN CONNECTIONS
1	+ INPUT
2	- INPUT
3	+ INPUT
4	ENABLE INPUT
5	INPUT COMMON

Note: All dimensions in parentheses are mm.  
Tolerances unless otherwise specified: .XX ± .03  
.XXX ± .010

2V

TOP

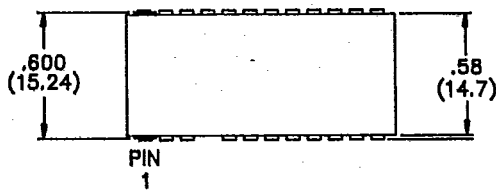

SIDE

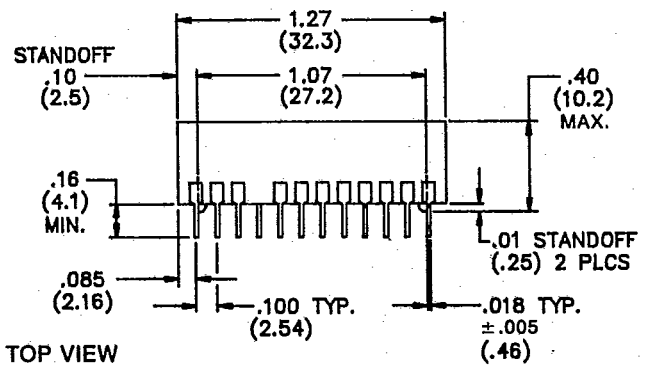

TOP VIEW  
2VP SERIES

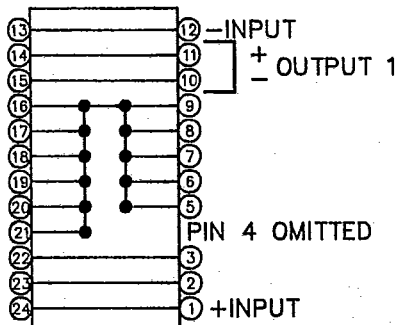

TOP VIEW  
2VI5U9

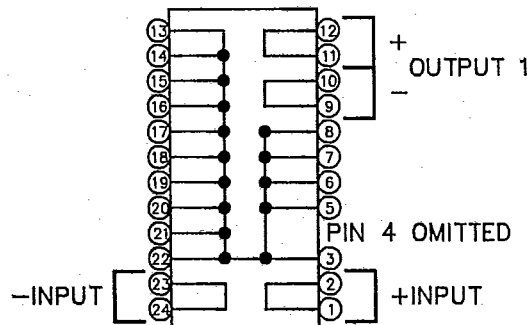

**MECHANICAL DIMENSIONS AND PIN CONNECTIONS**

**2PC**

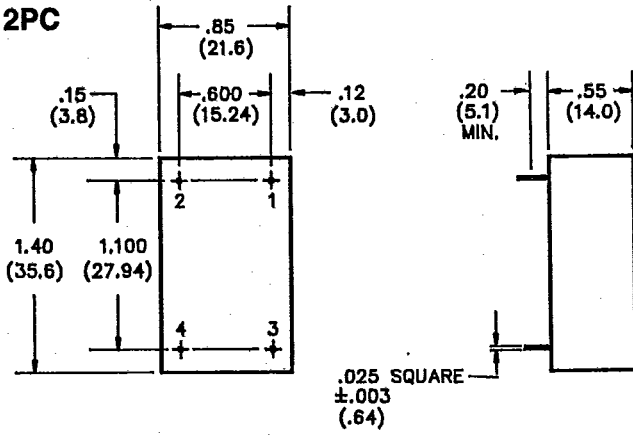

PIN	PIN CONNECTIONS
1	+ INPUT
2	- INPUT
3	+ OUTPUT
4	- OUTPUT

**SP**

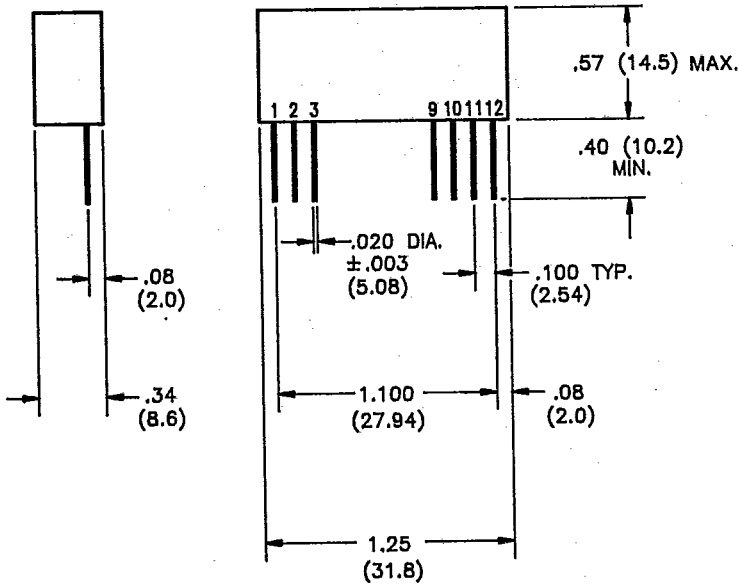

PIN	SINGLE OUTPUT
1	+ INPUT
2	NC
3	NC
9	NC
10	- OUTPUT
11	+ OUTPUT
12	- INPUT

Note: All dimensions in parentheses are mm.  
 Tolerances unless otherwise specified: .XX ± .03  
 .XXX ± .010

### PERFORMANCE DATA 2VP5U9 & 2VI5U9

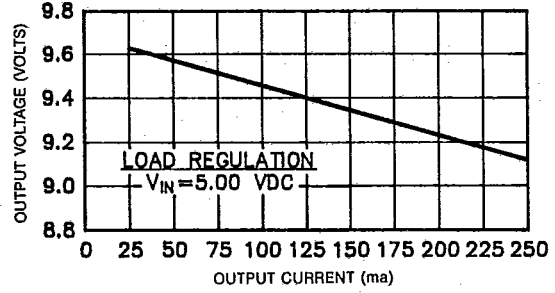
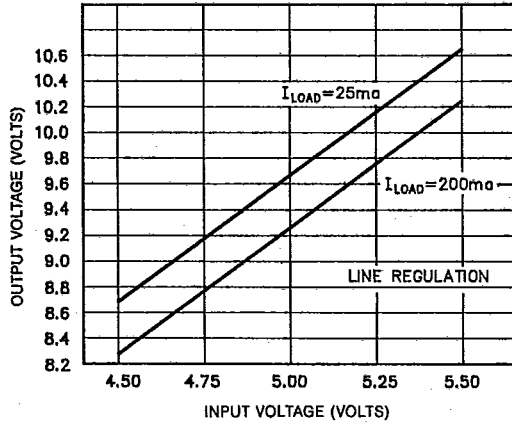

### PERFORMANCE DATA 2VP12U9

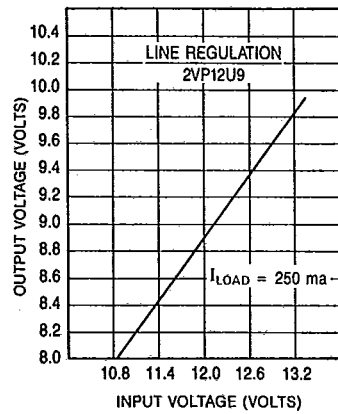
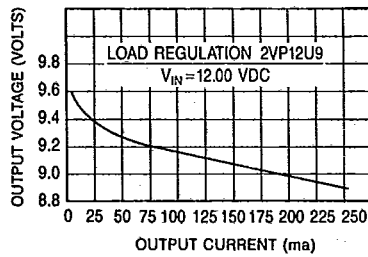

### 2E12R9

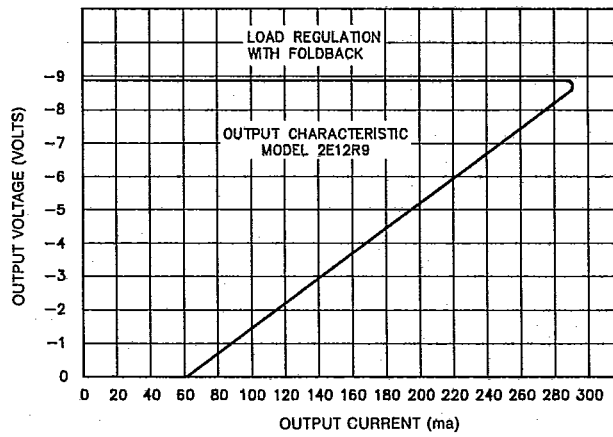

## APPLICATIONS

The Reliability family of Lan-Pac converters is designed to provide the isolated power requirements for transceiver integrated circuits used in either Ethernet or Cheapernet Local Area Networks.

For Ethernet applications, IEEE 802.3 specifies a power connection cable not more than 50 meters long with the Vc (voltage common) line capable of sinking 2 amps. Also, the DC power pair shall be composed of a twisted pair of sufficient gauge stranded wires to result in a nominal DC resistance not to exceed 1.75 ohms per conductor. Furthermore, IEEE 802.3 requires that the local power supply be capable of operating at one fixed level (VP) between + 12 VDC - 6% and + 15VDC + 5% with respect to circuit Vc for all current values from 0 to 500 ma.

From the above, we can see that the minimum input voltage to the Lan-Pac Converter is:

$$12 - (12 \times 0.06) - (3.5 \text{ ohms}) (\text{Input current}) \text{ or } 11.28 - 3.5 I_{in} = V_{min}$$

similarly, the maximum input voltage is:

$$15 + (15 \times 0.05) - (3.5 \text{ ohms}) (\text{Input current}) \text{ or } 15.75 - 3.5 I_{in} = V_{max}$$

with a total power cable resistance of 3.5 ohms.

Obviously, with no input current or zero cable resistance the maximum input voltage to the Ethernet DC/DC converters is 15.75 and is so specified in the General Electrical Specifications. However, as regards minimum input voltage, all Ethernet converters are guaranteed to meet their specifications with a local power supply voltage of 11.28V and source impedance of 3.5 ohms, while the converter is operating at maximum output current.

