

RAPPROVAL SHEET

承 認 書

Customer

客戶名稱:

KUK JAE TELE PARTS CO., LTD.

Description:

產品描述: D-SUB Socket High Density Right Angle Type

Part No.:

客戶編號:

Part No.:

繼德編號:

5510-XXS-XX-XX-F1

Date 日期:

MAY-02-2008

Rev. 版次:

A

經辦(Evaluted)	審核(Checked)	核準(Approval)	客戶承認(Approval)
Yang xia	Jeremy Liu	Mike Wu	



UL:Recognized NO. E 144392



繼德工業股份有限公司
Neltron Industrial Co., Ltd.

Head Office

臺北市士林區承德路四段 184 號 2 樓

2F, 184, Chang -Teh Road, Sec. 4, Shih-Lin, Taipei, Taiwan, R.O.C.

TEL:886-2-28802631(10 Lines) FAX:886-2-28802710 ·28802888

<http://www.neltron.com.tw> E-mail : neltron@neltron.com.tw

China Factory

中國廣東省東莞市塘廈鎮科苑城橫田二路一號

Science Service Plaza ,1,Hengtian Second Road ,

Tangxia Town Dongguan City .Guangdong Province ,China



繼德工業股份有限公司
Neltron Industrial Co., Ltd.

Bill of Approval Sheet

www.DataSheet4U.com Product Description: D-SUB Socket High Density Right Angle Type

Product Part NO.: 5510-XXS-XX-XX-F1

ate: MAY-02-2008

Index	Item
1	Cover
2	Bill of Approval Sheet
3	Customer drawing
4~6	Product specification
7	Plastic
8~12	Plastic SGS
13	Terminal
14~16	Terminal SGS
17	Shell Material
18~20	Shell SGS
21~22	Plating
23~31	Plating SGS
32~35	UL Card

5510-XXS-01-XX-F1

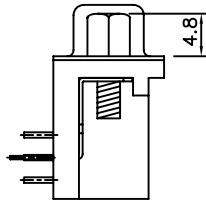

5510-XXS-02-XX-f1

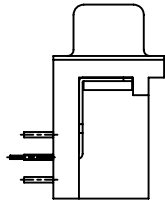

5510-XXS-02A-XX-F1

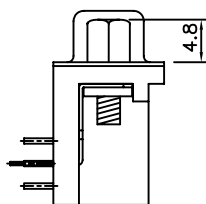

5510-XXS-02B-XX-F1

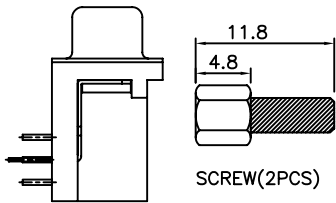

SCREW(2PCS)

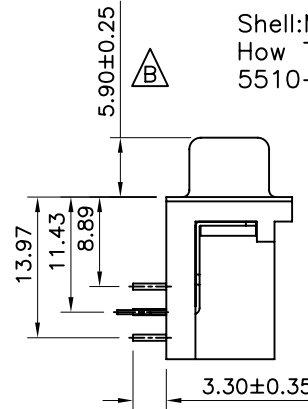
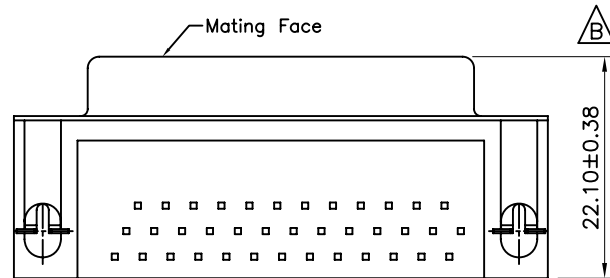
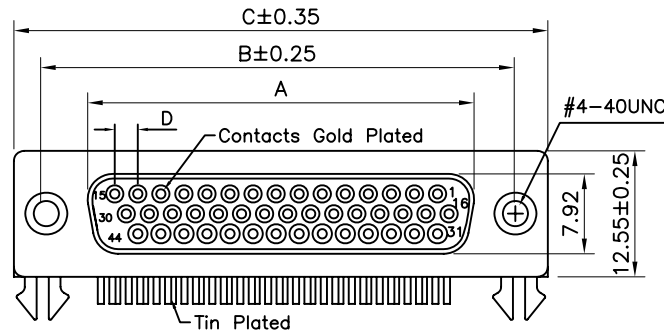

Pos	A	B	C	D	E
15	16.33	24.99	30.81	2.29	0.25
26	24.66	33.32	39.14	2.29	0.51
44	38.38	47.04	53.04	2.29	0.51
62	54.84	63.50	69.32	2.41	0.58

Specifications

Current Rating:3.0A AC/DC
 Voltage Rating:250V AC/DC
 Contact Resistance:30m ohm. max.
 Insulation Resistance: 5,000M ohm. min.
 Withstanding Voltage:1,000V AC For One Minute
 Operating Temperature Range:-40°C ~ +85°C

Materials and Finish
 Insulator:High Temp. Plastic (PBT UL 94V-0)
 Contact:Phosphor Bronze Nickel Undercoated
 ,Selective Gold plated
 Shell:Metal Iron With Tin Plated

How To Order

5510-XXS-XX-XX-F1

- Lead Free
- 01:Full Gold plated
- 03:Selective Gold Plated
- 01:Board Lock/Hex Screw
- 02:Rivet W/Board Lock
- 02A:Rivet W/Board Lock/Hex Screw
- 02B:Rivet W/Board Lock/Attached Hex Screw
- S:Socket
- No.Of Positions

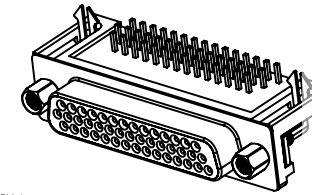

www.DataShee4U.com

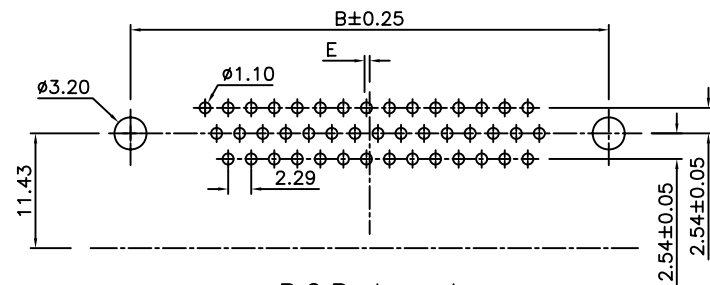

P.C.B. Layout

RoHS Compliant

E				
D				
C				
B	14-Mar-2007	ECN-CN070310	Mary	
A	31-Aug-2005	(PC0052)	Cel King	
REV	DATE	FILE	BY	

DRAWN: Cel King

CHECKED: Jeremy Liu

APPROVAL: Mike Wu

GENERAL TOLERANCE:
 .X=±0.2
 .XX=±0.15

UNIT: mm

SCALE:

SHEET: 1 / 1

PROJECTION:



繼德工業股份有限公司

Neltron Industrial Co., Ltd.

DESCRIPTION: D-SUB Socket High Density Right Angle Type

PART NO: 5510-XXS-XX-XX-F1

SIZE

A4

PRODUCT SPECIFICATION

1.Scope

This specification covers D-SUB Socket High Density Right Angle Type

2.Product name and part number

Product Name	Part Number
D-SUB Socket High Density Right Angle Type	5510-XXS-XX-XX-F1

3.Material/Finish

Name	Material	Finish	Color
Plastic	PBT (UL94V-0)		
Terminal	Phosphor Bronze	Selective Gold Plated	
Shell	Metal Iron	Tin Plated	

*Refer to the drawing.

4.Rating

Item	Standard	
Rated Voltage (MAX.)	250 V	AC/DC
Rated Current (MAX.)	3.0 A	
Ambient Temperature Range	-40°C~+85°C	

*1: Including terminal temperature rise.

5. Performance

5-1.Electrical Performance

Item		Test Condition	Requirement
5-1-1	Contact Resistance	Mate connectors D-SUB Socket High Density Right Angle Type and measure by dry circuit, 20mVMAX.10mA. (JIS C5402 5.4)	30mΩ MAX
5-1-2	Insulation Resistance	Mate connectors D-SUB Socket High Density Right Angle Type and apply 1000V DC between adjacent terminal or ground. (JIS C5402 5.2/MIL-STD-202 Method 302)	5000MΩ MIN
5-1-3	Dielectric Strength	Mate connectors D-SUB Socket High Density Right Angle Type and apply 1000V AC (rms) for 1 minute between adjacent terminal or ground. (JIS C5402 5.1/MIL-STD-202 Method 301)	No Breakdown

5-2 Mechanical Performance

Item		Test Condition		Requirement
5-2-1	Insertion and Withdrawal	Insert and withdraw connectors at the speed rate of 25±3mm/minute.	Insertion Force	Kgf/Pin(Max)

	Force	Withdrawal Force	Kgf/Pin(Min)
5-2-2	Terminal Retention Force	Apply axial pull out force at the speed rate of 25±3mm per minute.	kgf MIN

5-3. Environmental Performance and Others

Item	Test Condition		Requirement	
5-3-1	Repeated Insertion and Withdrawal	When mated up to 30 cycles repeatedly by the rate of 10 cycles per minute.	Contact Resistance	30 mΩ MAX
5-3-2	Temperature Rise	Carrying rated current load. (UL 498)	Temperature rise	20 °C MAX
5-3-3	Vibration	Amplitude:1.5mm P-P Sweep time:10-55-10 Hz In 1 minute Duration: 2 hours in each of X.Y.Z axes (MIL-STD-202 Method 201)	Appearance	No Damage
			Contact Resistance	30 mΩ MAX
			Discontinuity	1μsec. MAX
5-3-4	Shock	490m/S ² (50G),3 strokes in each X, Y, Z axes. (JIS C0041/MIL-STD-202 Method 213)	Appearance	No Damage
			Contact Resistance	30 mΩ MAX
			Discontinuity	1μsec. MAX.
5-3-5	Heat Resistance	85±2°C 48hours (JIS C0021/MIL-STD-202 Method 108)	Appearance	No Damage
			Contact Resistance	30mΩ MAX
5-3-6	Cold Resistance	-40±3°C 48 hours (JIS C0020)	Appearance	No Damage
			Contact Resistance	20 mΩ MAX
5-3-7	Humidity	Temperature: 60±2°C Relative Humidity:90~95% Duration: 96hours (JIS C0022/MIL-STD-202 Method 103)	Appearance	No Damage
			Contact Resistance	30 mΩ MAX
			Dielectric Strength	Must meet 4-1-3
			Insulation Resistance	5000MΩ MIN
5-3-8	Temperature Cycling	5 cycles of: a)-55°C 30 minutes b)+105°C 30 minutes (JIS C0025)	Appearance	No Damage
			Contact Resistance	30 mΩ MAX
5-3-9	Salt Spray	12±4 hours exposure to a salt spray from the 5±1% solution at 35±2°C (JIS C0023/MIL-STD-202 Method 101)	Appearance	No Damage
			Contact Resistance	20mΩ MAX
5-3-10	SO ₂ Gas	24 hours exposure to 50±5ppm. SO ₂ gas at 40±2°C	Appearance	No Damage
			Contact Resistance	30 mΩ MAX
5-3-11	NH ₃ Gas	40 minutes exposure to NH ₃ gas evaporating from 28% Ammonia solution	Appearance	No Damage
			Contact Resistance	30mΩ MAX

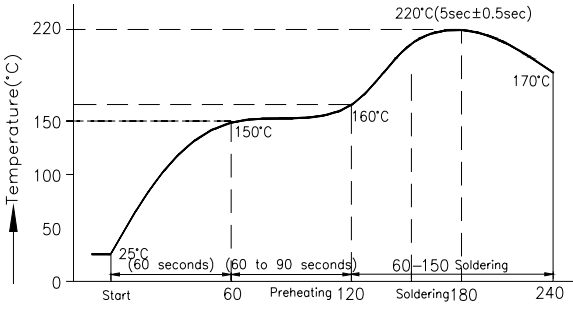
5-3-12	Solder-ability	Solder Time:5±0.5 sec. Solder Temperature:220±5°C	Solder Wetting	95% of immersed area must show no voids, pin holes
5-3-13	Resistance To Soldering Heat	Soldering Time:5±0.5 sec. Solder Temperature:220±5°C	Appearance	No Damage
5-3-14	Soldering Profile 5-3-14-1 Manual soldering 5-3-14-2Wave Soldering	Solder temp: 400±5°C Time: 5± 0.5 sec Soldering temp : 220 ± 5°C Soldering time : 5 ± 0.5 s Preheating : 150 ± 10°C for 1 to 2 min.  <p style="text-align: center;">Time Max-6minute PBT Recommended Temperature Profile</p>	Supplier to provide measured data into the Table 1.	

SHINITE™ PBT

性質	METHOD	UNIT	D201	D201G15	D201G30	D202
比重	D792	---	1.31	1.39	1.52	1.40
含水率	D570	%	0.09	0.07	0.07	0.08
模收縮						
流動方向	D955	%	0.8 - 2.0	0.3 - 0.5	0.2 - 0.4	0.6 - 1.9
垂直方向			0.8 - 2.0	0.5 - 0.9	0.5 - 0.9	0.6 - 1.9
抗張強度	D638	kg/cm ²	550	1000	1250	600
伸長率	D638	%	40	4	4	6
彎曲強度	D790	kg/cm ²	850	1600	2100	900
彎曲模數	D790	kg/cm ²	25000	52000	90000	26000
衝擊強度缺口 1/8" (23°C)	D256	kg x cm/cm	4	8	10	4
洛式硬度	D785	R	118	120	120	118
熱變形溫度	D648	°C	65	205	210	70
耐燃性	UL-94	---	HB	HB	HB	V0
介電強度	D149	KV/MM	15	15	20	15
介電常數	D150	---	3	3	4	3
體積電阻	D257	Ω-CM	1.00E+16	1.00E+16	1.00E+16	1.00E+16

性質	METHOD	UNIT	D202G15	D202G20	D202G30	E202G15	E202G30
比重	D792	---	1.49	1.53	1.62	1.50	1.61
含水率	D570	%	0.07	0.07	0.07	0.07	0.07
模收縮							
流動方向	D955	%	0.3 - 0.5	0.3 - 0.5	0.2 - 0.4	0.3 - 0.5	0.2 - 0.4
垂直方向			0.5 - 0.9	0.5 - 0.9	0.5 - 0.9	0.5 - 0.9	0.5 - 0.9
抗張強度	D638	kg/cm ²	950	1100	1300	920	1300
伸長率	D638	%	4	4	4	4	3
彎曲強度	D790	kg/cm ²	1600	1750	1950	1470	2000
彎曲模數	D790	kg/cm ²	60000	70000	95000	58000	93000
衝擊強度缺口 1/8" (23°C)	D256	kg x cm/cm	6	7.5	9	5.5	8.5
洛式硬度	D785	R	120	120	120	120	120
熱變形溫度	D648	°C	200	205	210	205	210
耐燃性	UL-94	---	V0	V0	V0	V0	V0
介電強度	D149	KV/MM	20	20	20	20	20
介電常數	D150	---	3	4	4	3	4
體積電阻	D257	Ω-CM	1.00E+16	1.00E+16	1.00E+16	1.00E+16	1.00E+16

一般級	D201
玻璃纖維強化級	D201G15 D201G30
防火級	D202
玻纖強化防火級	D202G15-G30
玻璃纖維強化級E系列	E202G15-G30

C201, D201G15, D201G30, D202, D202G5-30 UL File No. E107536 (M)

1. 以上數據僅供參考，實際數據以產品檢驗報告為準。
2. 如有任何特別需求，請洽營業人員，謝謝。

Test Report

No. : CE/2007/B4310A

Date : 2007/12/12

Page : 1 of 5

SHINKONG SYNTHETIC FIBERS CORPORATION

8F., NO. 123, SEC. 2, NANKING E. RD., TAIPEI, TAIWAN, R. O. C.

TEL : +886-3-4932131 Ext. 1732 FAX : +886-3-4915763



The following sample(s) was/were submitted and identified by/on behalf of the client as :

Sample Description : THERMOPLASTIC POLYESTER RESIN
Style/Item No. : SHINITE[®] PBT E202G15BK
Manufacturer/Vendor : SHINKONG SYNTHETIC FIBERS CORPORATION
Country of Origin : TAIWAN
Sample Receiving Date : 2007/11/16
Testing Period : 2007/11/16 TO 2007/11/23

=====
Test Requested : In accordance with the RoHS Directive 2002/95/EC, and its amendment directives.
Test Method : With reference to IEC 62321, Ed.1 111/54/CDV Procedures for the Determination of Levels of Regulated Substances in Electrotechnical Products.
(1) Determination of Cadmium by ICP-AES.
(2) Determination of Lead by ICP-AES.
(3) Determination of Mercury by ICP-AES.
(4) Determination of Hexavalent Chromium for non-metallic samples by UV/Vis Spectrometry.
(5) Determination of PBB and PBDE by GC/MS.
Test Result(s) : Please refer to next page(s).

Chenyu Kung / Operation Manager
Signed for and on behalf of
SGS TAIWAN LTD.
Chemical Laboratory – Taipei

Test Report

No.: CE/2007/B4310A Date: 2007/12/12

Page: 2 of 5

SHINKONG SYNTHETIC FIBERS CORPORATION

8F., NO. 123, SEC. 2, NANKING E. RD., TAIPEI, TAIWAN, R. O. C.

TEL: +886-3-4932131 Ext. 1732 FAX: +886-3-4915763



Test results by chemical method (Unit: mg/kg)

Test Item (s):	Method (Refer to)	Result	MDL
		No.1	
Cadmium (Cd)	(1)	n.d.	2
Lead (Pb)	(2)	14	2
Mercury (Hg)	(3)	n.d.	2
Hexavalent Chromium Cr(VI) by alkaline extraction	(4)	n.d.	2
Sum of PBBs	(5)	n.d.	-
Monobromobiphenyl		n.d.	5
Dibromobiphenyl		n.d.	5
Tribromobiphenyl		n.d.	5
Tetrabromobiphenyl		n.d.	5
Pentabromobiphenyl		n.d.	5
Hexabromobiphenyl		n.d.	5
Heptabromobiphenyl		n.d.	5
Octabromobiphenyl		n.d.	5
Nonabromobiphenyl		n.d.	5
Decabromobiphenyl		n.d.	5
Sum of PBDEs (Mono to Nona) (Note 4)		n.d.	-
Monobromobiphenyl ether		n.d.	5
Dibromobiphenyl ether		n.d.	5
Tribromobiphenyl ether		n.d.	5
Tetrabromobiphenyl ether		n.d.	5
Pentabromobiphenyl ether		n.d.	5
Hexabromobiphenyl ether		n.d.	5
Heptabromobiphenyl ether		n.d.	5
Octabromobiphenyl ether		n.d.	5
Nonabromobiphenyl ether	n.d.	5	
Decabromobiphenyl ether	n.d.	5	
Sum of PBDEs (Mono to Deca)	n.d.	-	

TEST PART DESCRIPTION:

NO.1 : BLACK PLASTIC PELLETS

- Note :
1. mg/kg = ppm
 2. n.d. = Not Detected
 3. MDL = Method Detection Limit
 4. According to 2005/717/EC DecaBDE is exempt.
 5. "-" = Not Regulated

Test Report

No.: CE/2007/B4310A Date: 2007/12/12

Page: 3 of 5

SHINKONG SYNTHETIC FIBERS CORPORATION

8F., NO. 123, SEC. 2, NANKING E. RD., TAIPEI, TAIWAN, R. O. C.

TEL: +886-3-4932131 Ext. 1732 FAX: +886-3-4915763



- 1) These samples were dissolved totally by pre-conditioning method according to below flow chart.
(Cr⁶⁺ test method excluded)

www.DataSheet4U.com

- 2) Name of the person who made measurement: Troy Chang
- 3) Name of the person in charge of measurement: Chenyu Kung

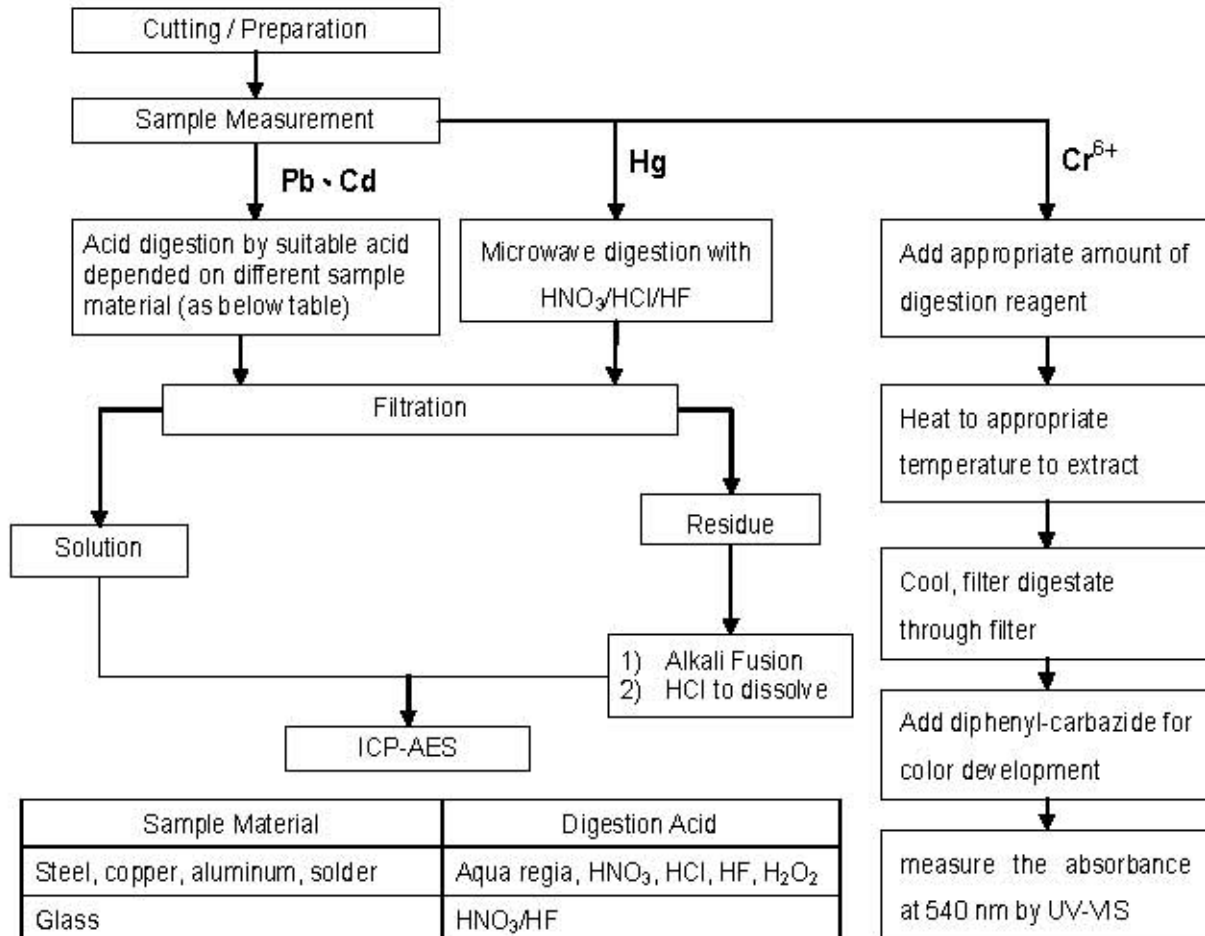

Sample Material	Digestion Acid
Steel, copper, aluminum, solder	Aqua regia, HNO ₃ , HCl, HF, H ₂ O ₂
Glass	HNO ₃ /HF
Gold, platinum, palladium, ceramic	Aqua regia
Silver	HNO ₃
Plastic	H ₂ SO ₄ , H ₂ O ₂ , HNO ₃ , HCl
Others	Any acid to total digestion

Test Report

No.: CE/2007/B4310A Date: 2007/12/12

Page: 4 of 5

SHINKONG SYNTHETIC FIBERS CORPORATION
 8F., NO. 123, SEC. 2, NANKING E. RD., TAIPEI, TAIWAN, R. O. C.
 TEL: +886-3-4932131 Ext. 1732 FAX: +886-3-4915763



PBB/PBDE analytical FLOW CHART

First testing process →

Optional screen process - - - - -

Confirmation process - - - - -

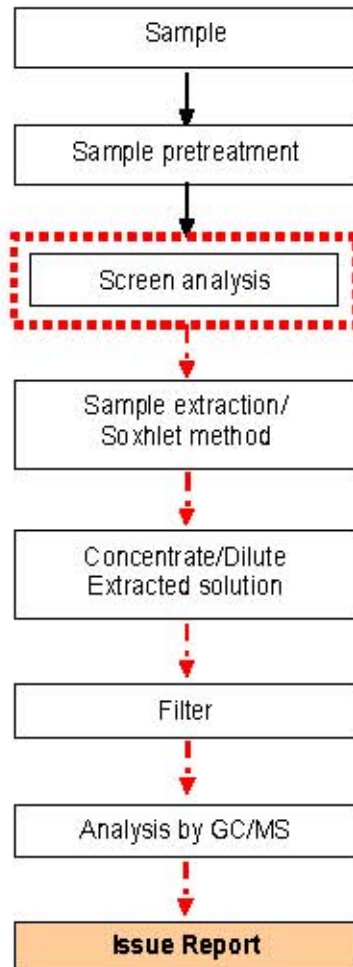

www.DataSheet4U.com

Test Report

No. : CE/2007/B4310A Date : 2007/12/12

Page : 5 of 5

SHINKONG SYNTHETIC FIBERS CORPORATION
8F., NO. 123, SEC. 2, NANKING E. RD., TAIPEI, TAIWAN, R. O. C.
TEL : +886-3-4932131 Ext. 1732 FAX : +886-3-4915763



** End of Report **



测试报告

编号: GZ0709142822/CHEM

日期: 2007年10月8日 页码 1 of 3

东莞市金乐金属材料有限公司
东莞市虎门镇镇口第二工业区 11 栋之二

以下测试之样品是由申请者所提供及确认: 高精度磷铜 C5191
客户参考信息: 高精度磷铜 C5191

www.DataSheet4U.com SGS 参考编号 : GC070906038

收板日期 : 2007年9月24日

信息确认日期 : 2007年9月26日

测试日期 : 2007年9月24日至2007年10月8日

测试要求 : 按照 RoHS 指令 2002/95/EC 及其修订文件要求进行测试。

测试方法 : 参照 IEC 62321 Ed.1 111/54/CDV 电子电器产品中限用物质含量的测定程序
(1) 用 ICP 测定镉的含量
(2) 用 ICP 测定铅的含量
(3) 用 ICP 测定汞的含量
(4) 用比色法测定六价格的含量

测试结果 : 请参见下一页

测试结论 : 基于所送样品进行的测试, 测试结果与欧盟 RoHS 指令 2002/95/EC 以及后续修正指令的要求相符。

Signed for and on behalf of
SGS-CSTC Ltd.

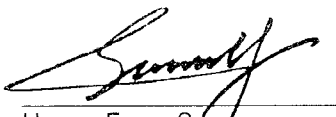
Huang Fang, Sunny
Sr. Engineer

This Test Report is issued by the Company subject to its General Conditions of Service printed overleaf or available on request and accessible at www.sgs.com. Attention is drawn to the limitations of liability, indemnification and jurisdictional issues defined therein. Unless otherwise stated the results shown in this test report refer only to the sample(s) tested. This test report cannot be reproduced, except in full, without prior written permission of the Company. Any unauthorized alteration, forgery or falsification of the content or appearance of this report is unlawful and offenders will be prosecuted to the fullest extent of the law.



198 Kezhu Road, SCIENTECH Park Guangzhou Economic & Technology Development District, Guangzhou, China 510663
中国·广州·经济技术开发区科学城科珠路198号 邮编: 510663

t (86-20) 82155555
t (86-20) 82155555

f (86-20) 82075125
f (86-20) 82075125

1582900
www.DataSheet4U.com
e sgs.china@sgs.com

Member of the SGS Group (SGS SA)



测试报告

编号: GZ0709142822/CHEM

日期: 2007年10月8日 页码 2 of 3

测试结果 (单位: 毫克/千克):

测试项目	参考方法	No.1	MDL	RoHS 限值
镉 (Cd)	(1)	N.D.	2	100
铅 (Pb)	(2)	18	2	1000
汞 (Hg)	(3)	N.D.	2	1000
沸水萃取法测六价铬(Cr VI)	(4)	Negative	参见 注释 4	#

测试部件描述:

No.1 铜色金属片

注释: 1. 毫克/千克 = ppm

2. N.D. = 未检出 (< MDL)

3. MDL = 方法检测限

4. 点测试:

Negative = 未检测到六价铬, Positive = 检测到六价铬;

(如果点测试结果不能确认, 测试样品将进一步由沸水萃取法进行测试)。

沸水萃取法:

Negative = 未检测到六价铬

Positive = 检测到六价铬: 每 50cm² 表面积的被测试样品的沸水萃取液中六价铬的浓度等于或大于 0.02mg/kg。

5. # Positive = 阳性, 表示结果与 RoHS 要求相抵触

Negative = 阴性, 表示结果与 RoHS 要求不相抵触

6. 本测试报告内容是参照报告编号为 GZ0709142821/CHEM 的中文译本, 中英文版本如有歧异, 概以英文版为准。

This Test Report is issued by the Company subject to its General Conditions of Service printed overleaf or available on request and accessible at www.sgs.com. Attention is drawn to the limitations of liability, indemnification and jurisdictional issues defined therein. Unless otherwise stated the results shown in this test report refer only to the sample(s) tested. This test report cannot be reproduced, except in full, without prior written permission of the Company. Any unauthorized alteration, forgery or falsification of the content or appearance of this report is unlawful and offenders will be prosecuted to the fullest extent of the law.





测试报告

编号: GZ0709142822/CHEM

日期: 2007年10月8日 页码 3 of 3

样品照片:

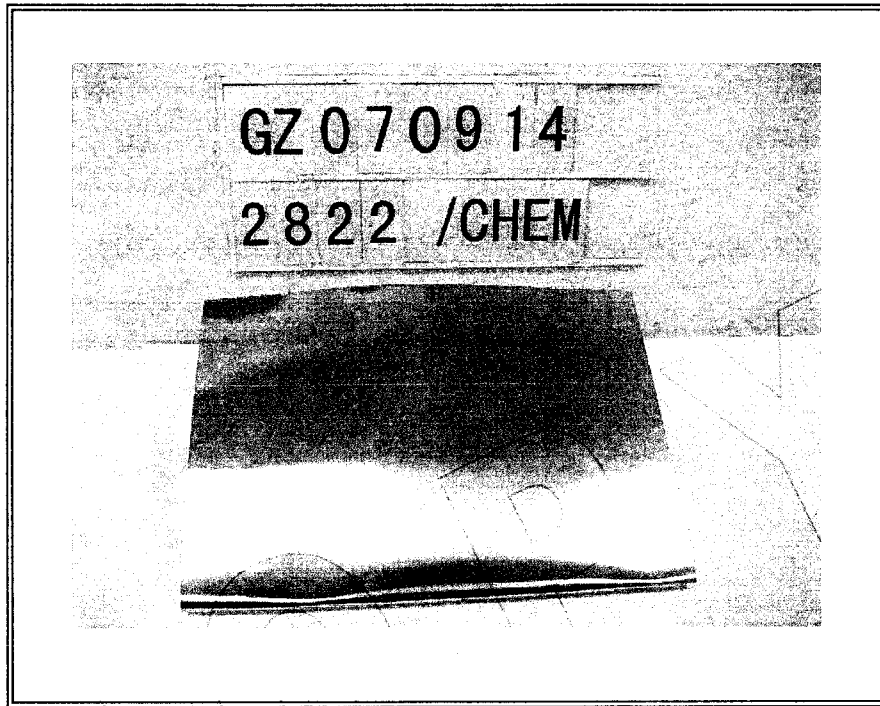

此图片仅限于随 SGS 正本报告使用

*** 报告完 ***

This Test Report is issued by the Company subject to its General Conditions of Service printed overleaf or available on request and accessible at www.sgs.com. Attention is drawn to the limitations of liability, indemnification and jurisdictional issues defined therein. Unless otherwise stated the results shown in this test report refer only to the sample(s) tested. This test report cannot be reproduced, except in full, without prior written permission of the Company. Any unauthorized alteration, forgery or falsification of the content or appearance of this report is unlawful and offenders will be prosecuted to the fullest extent of the law.



198 Kazhu Road, SCIENTECH Park, Guangzhou Economic & Technology Development District, Guangzhou, China 510663
中国·广州·经济技术开发区科学城科珠路198号 邮编: 510663

t (86-20) 82155555
t (86-20) 82155555

f (86-20) 82075125
f (86-20) 82075125

1582902
www.DataSheet4U.com
www.sgs.com
e sgs.china@sgs.com

試 験 成 績 書

INSPECTION CERTIFICATE

日 鉦 金 属 加 工 株 式 会 社 倉 見 工 場
KURAMI WORKS, NIKKO METAL MANUFACTURING CO., LTD.

需要家 同朋中国

CUSTOMER

扱 先 同朋香港 有限公司

MESSRS.

製品名 C5191R-H (190-210)

PRODUCTS

寸 法 0.25 X 305 X L

SIZE

規 格

SPECIFICATION

化 学 成 分

CHEMICAL COMPOSITIONS

発 行 日 2005年03月28日

DATE OF ISSUE

納 品 書 番 号 57166

DELIVERY SHEET NO.

注 文 番 号 NK5-0303

CONTRACT NO.

オ ー ダ ー 番 号 03

ORDER NO.

0002

品 質 保 証 課 長

MANAGER OF QUALITY

ASSURANCE SECTION

Hiromichi Watanabe

規 格 SPECIFICATION	Zn %	Sn %	P %	Fe %	Pb %	Cu+Sn+P %							
製造番号 MIN		5.5	0.05			99.7							
LOT NO. MAX	0.20	7.0	0.26	0.10	0.05								
62512	0.01	5.99	0.12	0.003	0.002	99.96							

質 量 MASS (KG)
5,136.00

機 械 的 お よ び 物 理 的 性 質

MECHANICAL AND PHYSICAL PROPERTIES

規 格 SPECIFICATION	引 張 強 さ TENSILE STRENGTH N/mm ²	伸 び ELONGATION %	硬 さ HARDNESS HV										寸 法 検 査 DIMENSIONAL INSPECTIONS	GOOD
製造番号 MIN	590	8.0	190										外 観 検 査 SURFACE INSPECTIONS	GOOD
LOT NO. MAX	685		210										備 考 REMARKS.	
62512	615	17.6	203.0											

この製品は品質管理計画に基づき製造され、検査・試験を行ない、規格に合格したことを証明する。

WE HEREBY CERTIFY THAT THE PRODUCTS DESCRIBED HEREIN HAVE BEEN MANUFACTURED, INSPECTED AND TESTED IN ACCORDANCE WITH THE SPECIFICATION AND Q.C. PROGRAM.

posco

Mill Test Certificate/검사증명서

Certificate No./증명서번호 :050929-KCSE-001-001
Date of Issue/발행일자:Sep., 30, 2005

Order No./계약번호:0002260731

PO No./주문번호:2260731
(65711)

Supplier/주문자:SSANGYONG CORPORATION

Commodity/품명:CR COIL

Customer/고객사:GOLDBASE STEEL CO., LTD

Spec & Type/규격:JIS G3141 SPCC-SD

www.DataSheet4U.com

Size/치수	Product No. 제품번호	Quantity 수량	Weight 중량 (kg)	Heat No. 재강번호	POSITION	Tensile/인장시험			Hardness 경도 HRB	Base Metal Base Bend	DIVISION	Chemical Composition/화합성분 (%)					
						YP (MPa)	TS (%)	EL (%)				C	Si	Mn	P	S	
0.50x1245xC	CPW3809AA	1	5,420	SP33155	T	179	309	47	36.7	Good	L	24	Tr	54	108	96	
0.50x1245xC	CPW3809B	1	8,330	SP33155	T	179	309	47	36.7	Good	L	24	Tr	54	108	96	
0.50x1245xC	CPW3809C	1	7,820	SP33155	T	179	309	47	36.7	Good	L	24	Tr	54	108	96	
0.50x1245xC	CPW5413A	1	7,960	SP33155	T	170	300	47	37.4	Good	L	24	Tr	54	108	96	
0.50x1245xC	CPW5413B	1	8,010	SP33155	T	170	300	47	37.4	Good	L	24	Tr	54	108	96	
0.50x1245xC	CPW5413C	1	7,520	SP33155	T	170	300	47	37.4	Good	L	24	Tr	54	108	96	
*** Sub Total (010) ***			6				45,060 (kg)			< No Weld >							
0.60x1219xC	CRW2807A	1	8,680	SP33155	T	164	299	48	34.5	Good	L	24	Tr	54	108	96	
0.60x1219xC	CRW2807B	1	8,680	SP33155	T	164	299	48	34.5	Good	L	24	Tr	54	108	96	
0.60x1219xC	CRW2807CA	1	8,370	SP33155	T	164	299	48	34.5	Good	L	24	Tr	54	108	96	
0.60x1219xC	CRW2808A	1	6,700	SP33155	T	165	297	48	35.3	Good	L	24	Tr	54	108	96	
0.60x1219xC	CRW2808B	1	6,520	SP33155	T	165	297	48	35.3	Good	L	24	Tr	54	108	96	
0.60x1219xC	CRW2808C	1	6,520	SP33155	T	165	297	48	35.3	Good	L	24	Tr	54	108	96	
0.60x1219xC	CRW2808D	1	6,380	SP33155	T	165	297	48	35.3	Good	L	24	Tr	54	108	96	
*** Sub Total (020) ***			7				51,850 (kg)			< No Weld >							
0.70x1219xC	CRW2837A	1	8,580	SP33155	T	178	312	47	36.7	Good	L	24	Tr	54	108	96	
0.70x1219xC	CRW2837B	1	8,580	SP33155	T	178	312	47	36.7	Good	L	24	Tr	54	108	96	
0.70x1219xC	CRW2837C	1	8,590	SP33155	T	178	312	47	36.7	Good	L	24	Tr	54	108	96	
*** Sub Total (030) ***			3				25,750 (kg)			< No Weld >							

* Position - T : Top, M : Middle, B : Bottom
 * Tensile Test Direction : Longitudinal, Gauge Length : 50mm(Rectangular).
 * Division - L:Ladle Analysis * Tr(Trace)
 * Chemical Composition Unit: -2x1/100, -3x1/1000, -4x1/10000, -5x1/100000

We hereby certify that the material herein has been made in accordance with the order and specification.

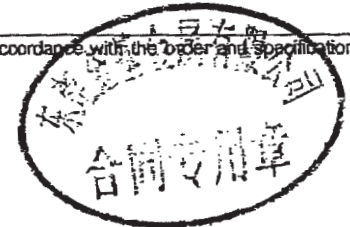

* This Mill Test Certificate cannot be copied for any purpose.

Surveyor To:

Handwritten signature



K7-102, 10 MAR. 01. 2005

CIXI ZHANGQI HENG FENG WU JIN FACTORY
NEAR OF NO.329 NATIONAL HIGHWAY ZHANGQI TOWN CIXI CITY ZHEJIANG PROVINCE
CHINA

The following sample(s) was/were submitted and identified on behalf of the clients as :

hardware fitting

SGS Job No. : 10914687 - GZ
Client Reference Information : screw aquare Base stud
Date of Sample Received : 26 Jul 2007
Testing Period : 28 Jul 2007 - 01 Aug 2007

Test Requested : To determine the Cadmium, Lead, Mercury & Hexavalent Chromium content in the submitted sample.

Test Method : With reference to IEC 62321 Ed.1 111/54/CDV Procedures for the Determination of Levels of Regulated Substances in Electrotechnical Products.

- (1) Determination of Cadmium by ICP.
Determination of Lead by ICP.
Determination of Mercury by ICP.
- (2) Determination of Hexavalent Chromium by Colorimetric Method.

Test Results : Please refer to next page(s).

Signed for and on behalf of
SGS-CSTC Ltd.

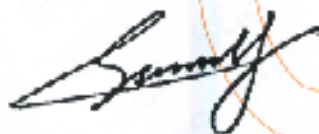

Huang Fang, Sunny
Sr. Engineer

This document is issued by the Company under its General Conditions of Service printed over and/or available on request and accessible at http://www.sgs.com/terms_and_conditions. Attention is drawn to the limitation of liability, indemnification and jurisdiction issues defined therein. Any holder of this document is advised that information contained herein reflects the Company's findings at the time of its intervention only and within the limits of Client's instructions, if any. The Company's sole responsibility is to its Client and this document is not intended to constitute a transaction between the parties to the transaction. Any use of this document for any other purpose, or any alteration, forgery or falsification of the content or appearance of this document is unlawful and offenders may be prosecuted to the fullest extent of the law. Unless otherwise stated the results shown in this test report refer only to the complete tested and given sample(s) and are valid for 30 days only. This document cannot be reproduced or copied in full without the prior approval of the Company.



GZCM1968396

Test Report

No. CANEC0001144001

Date: 22 Mar 2008

Page 2 of 3

Test results by chemical method (Unit : mg/kg)

Test Item(s)	Method (Refer to)	No.1	MDL
Cadmium(Cd)	(1)	14	2
Lead (Pb)	(1)	25978	2
Mercury (Hg)	(1)	N.D.	2
Hexavalent Chromium (CrVI) by boiling water extraction	(2)	Negative	See Note 4

Note:

1. mg/kg = ppm
2. N.D. = Not Detected (< MDL)
3. MDL = Method Detection Limit
4. Spot-test:

Negative = Absence of CrVI coating, Positive = Presence of CrVI coating;
(The tested sample should be further verified by boiling-water-extraction method if the spot test result cannot be confirmed.)

Boiling-water extraction:

Negative - Absence of CrVI coating

Positive = Presence of CrVI coating, the detected concentration in boiling-water-extraction solution is equal or greater than 0.02 mg/kg with 50 cm² sample surface area.

5. Results & photo(s) of this report refer to test report CANEC0700150200.

Test Part Description

No. 1 Silvery metal part

COPY

This document is issued by the Company under its General Conditions of service printed (available on request) and accessible at http://www.sgs.com/terms_and_conditions. Attention is drawn to the limitation of liability, indemnification and jurisdiction issues set forth therein. Any holder of this document is advised that information contained herein reflects the Company's findings at the time of its intervention only and within the limits of Client's instructions, if any. The Company's sole responsibility is to its Client and this document does not constitute a transaction from exercising all their rights and obligations under the transaction documents. Any unauthorized alteration, forgery or falsification of the content or appearance of this document is unlawful and offenders may be prosecuted to the fullest extent of the law. Unless otherwise stated, the results shown in this test report refer only to the sample(s) tested and such sample(s) are retained for 90 days only. This document cannot be reproduced or put in full, without prior approval of the Company.



地址: 中国·广州·经济技术开发区科学城科丰路199号 邮编: 510663

1 (86-20) 82186656
1 (86-20) 82186555

1 (86-20) 52075725
1 (86-20) 52075725

GZCM1968397

www.cn.sgs.com

Sample photo:



SGS authenticate the photo on original report only

*** End of Report ***

COPY

This document is issued by the Company under its General Conditions of Sale printed overleaf or available on request and accessible at http://www.sgs.com/terms_and_conditions. Attention is drawn to the limitation of liability, indemnification and limitation issues defined therein. Any holder of this document is advised that information contained herein reflects the Company's findings at the time of its intervention only and within the limits of Client's instructions, if any. The Company's sole responsibility is to its Client and this occurs between the separate parties to a transaction from exercising all their rights and obligations under the transaction documents. Any unauthorized alteration, forgery or falsification of the content or appearance of this document is unlawful and offenders may be prosecuted to the fullest extent of the law. The results otherwise stated in this report refer only to the sample(s) tested and such sample(s) are retained for 30 days only. This document cannot be reproduced without the written and approval of the Company.

MEAN TOP COAT = 1.06u"
 STD, DEVIATION = 0.176u"
 NO. OF MEAS. = 10

MEAN INT COAT = 54.321u"
 STD, DEVIATION = 3.454u"
 NO. OF MEAS. = 10

T meas = 10 s

LOCATE SPECIMEN
 TO MEASURE **PRESS " GO "**
 Xt1=0.009 Xn= 0.079

THICKNESS MEASUREMENT		
	Au	Ni
N= 1	THICKNESS=1.08u"	= 52.59u"
N= 2	THICKNESS=1.01u"	= 54.39u"
N= 3	THICKNESS=1.05u"	= 53.54u"
N= 4	THICKNESS=1.06u"	= 55.96u"
N= 5	THICKNESS=1.04u"	= 53.12u"

2006/10/13

MEAN TOP COAT = 50.321u"
 STD, DEVIATION = 3.454u"
 NO. OF MEAS. = 10

MEAN TOP COAT = 100.08u"
 STD, DEVIATION = 6.363u"
 NO. OF MEAS. = 10

T meas = 10 s

LOCATE SPECIMEN
 TO MEASURE **PRESS " GO "**
 Xt1= Xn=

THICKNESS MEASUREMENT		
	Tin	Ni
N= 1	THICKNESS=100.03u"	= 50.51u"
N= 2	THICKNESS=100.07u"	= 50.10u"
N= 3	THICKNESS=100.04u"	= 50.24u"
N= 4	THICKNESS=100.05u"	= 50.37u"
N= 5	THICKNESS=100.09u"	= 50.15u"

2006/12/13



Test Report

No. CANEC0800111003

Date: 16 Jan 2008

Page 1 of 3

SHENZHEN HONGJUN HARDWARE CO., LTD.
NO.3,DALANG INDUSTRY AREA,HONGXING VILLAGE SONGGANG TOWN,BAO'AN
DISTRICT,SHENZHEN
CHINA

The following sample(s) was/were submitted and identified on behalf of the clients as :

www.DataSheet4U.com
AU PLATING

SGS Job No. : 10787280 - SZ
SGS Internal Reference No. : 4.3
Date of Sample Received : 11 Jan 2008
Testing Period : 11 Jan 2008 - 16 Jan 2008

Test Requested : To determine the Cadmium, Lead, Mercury & Hexavalent Chromium content in the submitted sample.

Test Method : With reference to IEC 62321 Ed.1 111/54/CDV Procedures for the Determination of Levels of Regulated Substances in Electrotechnical Products.
(1) Determination of Cadmium by ICP.
Determination of Lead by ICP.
Determination of Mercury by ICP.
(2) Determination of Hexavalent Chromium by Colorimetric Method.

Test Results : Please refer to next page(s).

Signed for and on behalf of
SGS-CSTC Ltd.

Huang Fang, Sunny
Sr. Engineer

This Test Report is issued by the Company subject to its General Conditions of Service printed overleaf or available on request and accessible at www.sgs.com. Attention is drawn to the limitations of liability, indemnification and jurisdictional issues defined therein. Unless otherwise stated the results shown in this test report refer only to the sample(s) tested. This test report cannot be reproduced, except in full, without prior written permission of the Company. Any unauthorized alteration, forgery or falsification of the content or appearance of this report is unlawful and offenders may be prosecuted to the fullest extent of the law.

Test Report

No. CANEC0800111003

Date: 16 Jan 2008

Page 2 of 3

Test results by chemical method (Unit : mg/kg)

Test Item(s)	Method (Refer to)	No.1	MDL
Cadmium(Cd)	(1)	N.D.	2
Lead (Pb)	(1)	22	2
Mercury (Hg)	(1)	N.D.	2
Hexavalent Chromium (CrVI) by boiling water extraction	(2)	Negative	See Note 4

Note:

1. mg/kg = ppm
2. N.D. = Not Detected (< MDL)
3. MDL = Method Detection Limit
4. Spot-test:

Negative = Absence of CrVI coating, Positive = Presence of CrVI coating;
(The tested sample should be further verified by boiling-water-extraction method if the spot test result cannot be confirmed.)

Boiling-water-extraction:

Negative = Absence of CrVI coating
Positive = Presence of CrVI coating; the detected concentration in boiling-water-extraction solution is equal or greater than 0.02 mg/kg with 50 cm² sample surface area.

Test Part Description

No. 1 Golden/silvery plated metal

This Test Report is issued by the Company subject to its General Conditions of Service printed overleaf or available on request and accessible at www.sgs.com. Attention is drawn to the limitations of liability, indemnification and jurisdictional issues defined therein. Unless otherwise stated the results shown in this test report refer only to the sample(s) tested. This test report cannot be reproduced, except in full, without prior written permission of the Company. Any unauthorized alteration, forgery or falsification of the content or appearance of this report is unlawful and offenders may be prosecuted to the fullest extent of the law.

Sample photo:



SGS authenticate the photo on original report only

*** End of Report ***

This Test Report is issued by the Company subject to its General Conditions of Service printed overleaf or available on request and accessible at www.sgs.com. Attention is drawn to the limitations of liability, indemnification and jurisdictional issues defined therein. Unless otherwise stated the results shown in this test report refer only to the sample(s) tested. This test report cannot be reproduced, except in full, without prior written permission of the Company. Any unauthorized alteration, forgery or falsification of the content or appearance of this report is unlawful and offenders may be prosecuted to the fullest extent of the law.



Test Report

No. CANEC0800111004

Date: 16 Jan 2008

Page 1 of 3

SHENZHEN HONGJUN HARDWARE CO., LTD.
NO.3,DALANG INDUSTRY AREA,HONGXING VILLAGE SONGGANG TOWN,BAO'AN
DISTRICT,SHENZHEN
CHINA

The following sample(s) was/were submitted and identified on behalf of the clients as :

NI PLATING

SGS Job No. : 10787280 - SZ
SGS Internal Reference No. : 4.4
Date of Sample Received : 11 Jan 2008
Testing Period : 11 Jan 2008 - 16 Jan 2008

Test Requested : To determine the Cadmium, Lead, Mercury & Hexavalent Chromium content in the submitted sample.

Test Method : With reference to IEC 62321 Ed.1 111/54/CDV Procedures for the Determination of Levels of Regulated Substances in Electrotechnical Products.
(1) Determination of Cadmium by ICP.
Determination of Lead by ICP.
Determination of Mercury by ICP.
(2) Determination of Hexavalent Chromium by Colorimetric Method.

Test Results : Please refer to next page(s).

Signed for and on behalf of
SGS-CSTC Ltd.

Huang Fang, Sunny
Sr. Engineer

This Test Report is issued by the Company subject to its General Conditions of Service printed overleaf or available on request and accessible at www.sgs.com. Attention is drawn to the limitations of liability, indemnification and jurisdictional issues defined therein. Unless otherwise stated the results shown in this test report refer only to the sample(s) tested. This test report cannot be reproduced, except in full, without prior written permission of the Company. Any unauthorized alteration, forgery or falsification of the content or appearance of this report is unlawful and offenders may be prosecuted to the fullest extent of the law.

Test Report

No. CANEC0800111004

Date: 16 Jan 2008

Page 2 of 3

Test results by chemical method (Unit : mg/kg)

Test Item(s)	Method (Refer to)	No.1	MDL
Cadmium(Cd)	(1)	N.D.	2
Lead (Pb)	(1)	19	2
Mercury (Hg)	(1)	N.D.	2
Hexavalent Chromium (CrVI) by boiling water extraction	(2)	Negative	See Note 4

Note:

1. mg/kg = ppm
2. N.D. = Not Detected (< MDL)
3. MDL = Method Detection Limit
4. Spot-test:

Negative = Absence of CrVI coating, Positive = Presence of CrVI coating;
(The tested sample should be further verified by boiling-water-extraction method if the spot test result cannot be confirmed.)

Boiling-water-extraction:

Negative = Absence of CrVI coating
Positive = Presence of CrVI coating; the detected concentration in boiling-water-extraction solution is equal or greater than 0.02 mg/kg with 50 cm² sample surface area.

Test Part Description

No. 1 Silvery plated metal

This Test Report is issued by the Company subject to its General Conditions of Service printed overleaf or available on request and accessible at www.sgs.com. Attention is drawn to the limitations of liability, indemnification and jurisdictional issues defined therein. Unless otherwise stated the results shown in this test report refer only to the sample(s) tested. This test report cannot be reproduced, except in full, without prior written permission of the Company. Any unauthorized alteration, forgery or falsification of the content or appearance of this report is unlawful and offenders may be prosecuted to the fullest extent of the law.

GZCM 19 125 46

Sample photo:

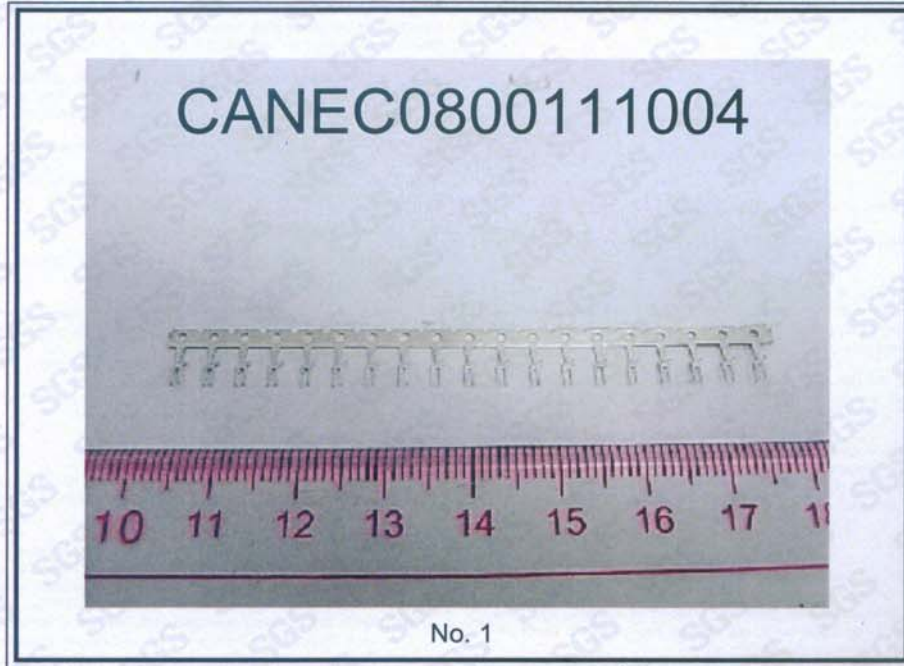

SGS authenticate the photo on original report only

*** End of Report ***

This Test Report is issued by the Company subject to its General Conditions of Service printed overleaf or available on request and accessible at www.sgs.com. Attention is drawn to the limitations of liability, indemnification and jurisdictional issues defined therein. Unless otherwise stated the results shown in this test report refer only to the sample(s) tested. This test report cannot be reproduced, except in full, without prior written permission of the Company. Any unauthorized alteration, forgery or falsification of the content or appearance of this report is unlawful and offenders may be prosecuted to the fullest extent of the law.



Test Report

No. CANEC0800111001

Date: 16 Jan 2008

Page 1 of 3

SHENZHEN HONGJUN HARDWARE CO., LTD.
NO.3,DALANG INDUSTRY AREA,HONGXING VILLAGE SONGGANG TOWN,BAO'AN
DISTRICT,SHENZHEN
CHINA

The following sample(s) was/were submitted and identified on behalf of the clients as :

MATTE SN PLATING

SGS Job No. : 10787280 - SZ
SGS Internal Reference No. : 4.1
Date of Sample Received : 11 Jan 2008
Testing Period : 11 Jan 2008 - 16 Jan 2008

Test Requested : To determine the Cadmium, Lead, Mercury & Hexavalent Chromium content in the submitted sample.

Test Method : With reference to IEC 62321 Ed.1 111/54/CDV Procedures for the Determination of Levels of Regulated Substances in Electrotechnical Products.
(1) Determination of Cadmium by ICP.
Determination of Lead by ICP.
Determination of Mercury by ICP.
(2) Determination of Hexavalent Chromium by Colorimetric Method.

Test Results : Please refer to next page(s).

Signed for and on behalf of
SGS-CSTC Ltd.

Huang Fang, Sunny
Sr. Engineer

This Test Report is issued by the Company subject to its General Conditions of Service printed overleaf or available on request and accessible at www.sgs.com. Attention is drawn to the limitations of liability, indemnification and jurisdictional issues defined therein. Unless otherwise stated the results shown in this test report refer only to the sample(s) tested. This test report cannot be reproduced, except in full, without prior written permission of the Company. Any unauthorized alteration, forgery or falsification of the content or appearance of this report is unlawful and offenders may be prosecuted to the fullest extent of the law.

Test Report

No. CANEC0800111001

Date: 16 Jan 2008

Page 2 of 3

Test results by chemical method (Unit : mg/kg)

Test Item(s)	Method (Refer to)	No.1	MDL
Cadmium(Cd)	(1)	N.D.	2
Lead (Pb)	(1)	18	2
Mercury (Hg)	(1)	N.D.	2
Hexavalent Chromium (CrVI) by boiling water extraction	(2)	Negative	See Note 4

Note:

1. mg/kg = ppm
2. N.D. = Not Detected (< MDL)
3. MDL = Method Detection Limit
4. Spot-test:

Negative = Absence of CrVI coating, Positive = Presence of CrVI coating;
(The tested sample should be further verified by boiling-water-extraction method if the spot test result cannot be confirmed.)

Boiling-water-extraction:

Negative = Absence of CrVI coating
Positive = Presence of CrVI coating; the detected concentration in boiling-water-extraction solution is equal or greater than 0.02 mg/kg with 50 cm² sample surface area.

Test Part Description

No. 1 Silvery plated metal

This Test Report is issued by the Company subject to its General Conditions of Service printed overleaf or available on request and accessible at www.sgs.com. Attention is drawn to the limitations of liability, indemnification and jurisdictional issues defined therein. Unless otherwise stated the results shown in this test report refer only to the sample(s) tested. This test report cannot be reproduced, except in full, without prior written permission of the Company. Any unauthorized alteration, forgery or falsification of the content or appearance of this report is unlawful and offenders may be prosecuted to the fullest extent of the law.

Sample photo:



SGS authenticate the photo on original report only

*** End of Report ***

This Test Report is issued by the Company subject to its General Conditions of Service printed overleaf or available on request and accessible at www.sgs.com. Attention is drawn to the limitations of liability, indemnification and jurisdictional issues defined therein. Unless otherwise stated the results shown in this test report refer only to the sample(s) tested. This test report cannot be reproduced, except in full, without prior written permission of the Company. Any unauthorized alteration, forgery or falsification of the content or appearance of this report is unlawful and offenders may be prosecuted to the fullest extent of the law.

ECBT2.E144392

Connectors for Use in Data, Signal, Control and Power Applications - Component

[Page Bottom](#)

Connectors for Use in Data, Signal, Control and Power Applications - Component

[See General Information for Connectors for Use in Data, Signal, Control and Power Applications - Component](#)
NELTRON INDUSTRIAL CO LTD

E144392

2ND FL
184 CHENG-TEH RD, SEC 4
SHIH-LIN, TAIPEI 111 TAIWAN

Wire to board connectors, Cat. Nos. 1310, 1311, 5289H followed by -02 thru -15; Cat. Nos. 8982H, 8980H, 8981H followed by -04; Cat. Nos. 2317RB, 2317RJ, 2317SB, 2317SJ, 2318HB, 2318HJ, 2417RJ, 2417SJ, 2418HJ followed by -02 thru -15; Cat. No. 2226A followed by -01 thru -40; Cat. No. 2226B followed by -02 thru -80; Cat. No. 2221 followed by -06, -12; Cat. No. 2222 followed by -06; Cat. No. 2220 followed by -02 thru -16; Cat. Nos. 2217R, 2217S, 2219R, 2219S followed by -02 thru -15; Cat. No. 2218H followed by -01 thru -15; Cat. No. 2026A followed by -01 thru -40; Cat. No. 2026B followed by -02 thru -80; Cat. No. 4400 followed by -44; Cat. No. 4401 followed by -10, -14, -16, -20, -24, -26, -30, -34, -40, -50, -60, -64; Cat. No. 4402 followed by -10, -14, -16, -20, -26, -34, -40, -44, -50, -60, -64; Cat. No. 4403 followed by -10, -14, -16, -20, -26, -30, -34, -40, -50, -60; Cat. No. 4404 followed by -14, -16, -18, -20; Cat. No. 4405 followed by -10, -14, -16, -20, -26; Cat. No. 4406 followed by -10, -14, -16, -20, -24, -26, -30, -34, -40, -50, -60, -64; Cat. No. 4501 followed by -20, -26, -32, -34, -40, -50, -52, -60, -68, -80, -100; Cat. No. 1200 followed by -03 thru -09; Cat. No. 1005 followed by -50, -100.

P.C.B connectors, Cat. No. 2162 followed by -16, -18, -20, -24; Cat. No. 2227 followed by -08, -14, -16, -18, -20, -24, -28, -40; Cat. No. 6605 followed by -72; Cat. No. 6602 followed by -30, -60; Cat. Nos. 1007, 1008 followed by -14, -20, -26, -30, -40, -50, -60, -68, -80, -100; Cat. No. 6601 followed by -20, -28, -32, -44, -52, -68, -84; Cat. No. 6603 followed by -68, -84, -85, -114, -121, -132; Cat. No. 1201 followed by -03 thru -08; Cat. No. 1202 followed by -05; Cat. No. 2416S followed by -20, -26, -32, -34, -40, -50, -52, -60, -68, -80, -100; Cat. Nos. 2216R, 2216S followed by -10, -12, -14, -16, -20, -24, -26, -30, -34, -40, -50, -56, -60, -64; Cat. Nos. 2516R, 2516S followed by -20, -26, -32, -34, -40, -50, -52, -60, -68, -80, -100; Cat. Nos. 2223R, 2223S followed by -02 thru -21; Cat. No. 2323S followed by -02 thru -20; Cat. No. 2316S followed by -10, -14, -16, -20, -26, -30, -34, -40, -50, -60, -64; Cat. No. 2525 followed by -10, -12, -20, -30, -40, -50, -60, -80, -100, -120; Cat. No. 2314S followed by -20, -26, -32, -34, -40, -50, -52, -60, -68, -80, -100; Cat. No. 2224 followed by -02 thru -15; Cat. Nos. 2211R, 2211S followed by -01 thru -40.

Cat. Nos. 2213R, 2213S followed by -02 thru -80; Cat. No. 2212S followed by -02 thru -40; Cat. No. 2214S followed by -02 thru -80; Cat. Nos. 2215R, 2215S followed by -10, -12, -16, -18, -20, -26, -30, -34, -40, -50, -60; Cat. No. 2225 followed by -36, -44, -50, -62, -80, -86, -100; Cat. No. 2207S followed by -02 thru -80; Cat. Nos. 2208R, 2208S followed by -02 thru -80; Cat. No. 2209S followed by -01 thru -40; Cat. Nos. 2210R, 2210S followed by -01 thru -40; Cat. No. 2206S followed by -01 thru -30; Cat. No. 41612 followed by -32, -48, -64, -96.

Mini jumpers, Cat. Nos. 2205, 2228 followed by -02.

Wire to wire connectors, Cat. No. 8182 followed by -04; Cat. Nos. 5005, 5006 followed by -01, -02, -03, -04A, -04B, -05, -06, -09, -12, -15.

D-Sub connectors, Cat. Nos. 5514P, 5514R followed by -13; Cat. Nos. 5512P, 5512S followed by -15, -26, -44, -62; Cat. No. 5511 followed by -09, -15, -25; Cat. No. 5510 followed by -15; Cat. Nos. 5509P, 5509S followed by -15, -26, -62; Cat. Nos. 5508P, 5508S followed by -15, -26, -44, -62; Cat. Nos. 5506P, 5506S followed by -09, -15, -25, -37; Cat. Nos. 5504PF1, 5504SF1, 5504SF2, 5505F1, 5505F2, 5503S, 5503P followed by -09, -15, -25, -37; Cat. Nos. 5501P, 5501S, 5502 followed by -09, -15, -19, -23, -25, -37, -50.

Centronic connectors, Cat. No. 5701 followed by -14, -24, -36; Cat. Nos. 5702, 5703, 5706 followed by -40; Cat. No. 5704 followed by -30; Cat. No. 5707 followed by -20.

www.DataSheet4U.com

Scart connectors, Cat. Nos. 1109, 1111, 1113 followed by -21; Cat. Nos. 1009, 1011, 1013 followed by -21; Cat. Nos. 1114R, 1114S followed by -21.

Connectors, Model No. 1002S followed by 30, 40, 50, 60 or 68; Model No. 1003-P-50; Model No. 1010 followed by 50 or 68, followed by P-PN; Model No. 1211 followed by 04, 06 or 08, followed by 04, 06 or 08; Model No. 1223 followed by -04 thru 30, followed by 02 or 03; Model No. 1224S followed by 04 thru 27; Model No. 1224SM followed by 04 thru 30; Model No. 1230S followed by 04 thru 15; Model No. 1230R followed by 04 thru 30; Model No. 1250HM followed by 02 thru 15; Model No. 1251SM followed by 02 thru 15; Model No. 1251RM followed by 02 thru 15; Model No. 1251S followed by 02 thru 15, followed by SMD; Model No. 1251R followed by 02 thru 15, followed by SMD; Model No. 1310H followed by 02 thru 15; Model No. 1394-06; Model No. 1778 followed by 16, 20, 22, 24, 28, 30, 32, 40, 42, 48, 52, 54, 56 or 64, followed by 03, 04 or 06; Model No. 1778MC followed by 16, 20, 24, 28, 30, 40, 42, 48, 52, 56 or 64, followed by 03, 04, 06 or 075; Model No. 1999P followed by 04 thru 80; Model No. 1999S followed by 04 thru 120, followed by A1, A2 or A3, followed by B1, B2 or B3; Model No. 2006H followed by 01, thru 06; Model No. 2006S followed by 01 thru 05; Model No. 2010 followed by 10 thru 12, followed by H1, H2, H3 or H4; Model No. 2011-10; Model No. 2016 followed by 10, 12, 14, 16, 20, 22, 24, 26, 30, 34, 36, 40, 44, 50, 60, 64 or 68; Model No. 2018 followed by P or R, followed by 02 thru 12; Model No. 2099P followed by 04 thru 10; Model 2099S followed by 04 thru 14; Model No. 2100P followed by 06 thru 20; Model 2100S followed by 04 thru 10; Model No. 2110 followed by 20, 30, 40, 50, 60, 80 or 100, followed by 34 or 44, followed by MM; Model No. 2114 followed by R, H or S, followed by 02 thru 10; Model No. 2150-08; Model No. 2198S followed by 10, 24, 30, 40, 44, 50, 60, 70, 80, 90 or 100, followed by A1 or A2; Model No. 2199SA followed by 04 thru 30, followed by 01 thru 03; Model No. 2199SB followed by 02 thru 10; followed by A1, A2 or A3, followed by B1 or B2, followed by C1 or C2; Model No. 2199R followed by 0 or 5, followed by 04 thru 30, followed by A1, A2 or A3, followed by B1 or B2, followed by C1 or C2; Model No. 2200SA followed by 05 thru 50, followed by A1 or A2; Model No. 2200SB followed by 10 thru 50, followed by A1 or A2; Model No. 2204 followed by S or R, followed by 02 thru 30; Model No. 2206SA followed by 01 thru 36, followed by 46; Model No. 2206SB followed by 02 thru 16, followed by 46; Model No. 2206PA followed by 01 thru 36, followed by 739; Model No. 2206PB followed by 02 thru 50, followed by 739; Model No. 2227MC followed by 06, 08, 10, 14, 16, 18, 20, 22, 24, 28, 32, 36, 40, 42, 48 or 64, followed by 03, 06 or 09; Model No. 2233 followed by S or R, followed by 03 thru 120; Model No. 2317 followed by SEH or REH, followed by 02 thru 15; Model No. 2317 followed by RM or SM, followed by 02 thru 10; Model No. 2318 followed by HM or HEH, followed by 02 thru 15; Model No. 2323 followed by R or S, followed by 04 thru 23, followed by A or B; Model No. 1016 followed by 09 or 15; Model No. 2007H followed by 02 thru 06; Model No. 2007S followed by 02 thru 05; Model No. 2324S followed by 04 thru 22; Model No. 2324R followed by 03 thru 30; Model No. 2392-5100; Model No. 2417 followed by SB or RB, followed by 02 thru 08; Model No. 2418HB followed by 02 thru 15; Model No. 3750R followed by 02 thru 12; Model No. 3750S followed by 02 or 03; Model No. 3920 followed by 02, 03, 04, 06, 09 or 12; Model No. 3921 followed by 02, 03, 04, 06, 09 or 12; Model No. 41815 followed by R, S or BE, followed by 02 thru 10; Model No. 4407 followed by 10, 14, 16, 20, 26, 34, 40, 50, 60 or 64; Model No. 4408 followed by 10, 12, 16, 20, 24, 26, 30, 34, 40 or 44; Model Nos. 5075AS-04, 5075BR-04, 5075AR-08B, 5075AR-04; Model No. 5197H followed by 02 thru 12; Model No. 5197 followed by S or R, followed by 02 thru 04, may be followed by 01; Model No. 5504F3-09P; Model No. 5513S followed by 3W3, 5W1, 7W2, 8W8, 11W1 or 13W3; Model No. 5515-13W3; Model No. 5557 followed by 02, 04, 06, 08, 10, 12, 14, 16, 18 or 20; Model No. 5559 followed by 02, 04, 06, 08, 10, 12 or 14; Model No. 5566S followed by 02, 04, 06, 08, 10, 12, 14, 16, 18 or 20; Model No. 5569R followed by 02, 04, 06, 08, 10, 12, 14, 16, 18 or 20, may be followed by 01; Model No. 6127 followed by S or P, followed by 02 thru 31; Model No. 6604P followed by 01 thru 40, followed by 9.1, 10.0, 10.6, 12.1 or 13.7; Model No. 6604S followed by 01 thru 40, may be followed by WR; Model No. 6610-321; Model No. 6610P-321, 6615-168-LE; Model No. 8981 followed by SA, SM or R, followed by 04; Model No. 8982S followed by 02 thru 08; Model No. SQJ followed by 24S, 26S, 28S, 28L, 32S or 40L; Model No. 4410-40.

Models 5589, 5321, 5592, 5594.

Cat. No. 1223, followed by 03 thru 32, followed by T or G; Cat. No. 1224R, followed by 03 thru 30; Cat. No. 1226, followed by 04 thru 50, followed by T or G; Cat. No. 1227, followed by S, R or SM, followed by 03 thru 30; Cat. No. 1253R, followed by 02 thru 16, 18, 20, 22, 24, 26, 28 or 30, followed by T or G; Cat. No. 1255R, followed by 02 thru 15, 20, 25 or 30; Cat. No. 1600, followed by S or R, followed by 02 thru 15 or 20, followed by T or G; Cat. Nos. 2000P, 2001S, followed by 10, 12, 14, 16, 18, 20, 22, 24, 26, 28, 30, 32, 34, 36, 38, 40, 50, 60, 70, 80, 100, 120, followed by G; Cat. No. 2017, followed by SM, S or R, followed by 10, 12, 14, 16, 20, 22, 24, 26, 30, 34, 40, 44, 50, 60, followed by G; Cat. Nos. 2208, 2213, followed by DI, S, R, SM or SMDI, followed by 02, 04, 06, 08, 10, 12, 14, 16, 18, 20, 22, 24, 26, 28, 30, 32, 34, 36, 38, 40, 42, 44, 46, 48, 50, 52, 54, 56, 58, 60, 62, 64, 66, 68, 70, 72, 74, 76, 78 or 80, followed by G, T or SG; Cat. No. 2209, followed by SM1, SM or S, followed by 2 thru 15, 18, 20, 23, 25, 28, 30, 33, 35, 38 or 40, followed by G, SG, SV or T; Cat. No. 2210, followed by DI, S, R, SM or SMDI, followed by 02, 04, 06, 08, 10, 12, 14, 16, 18, 20, 22, 24, 26, 28, 30, 32, 34, 36, 38 or 40, followed by G, T or SG; Cat. No. 2212TBA, followed by 01 thru 40, followed by G; Cat. Nos. 2214R, 2214TBA, followed by 04, 06, 08, 10, 12, 14, 16, 18, 20, 22, 24, 26, 28, 30, 32, 34, 36, 38, 40, 42, 44, 46, 48, 50, 52, 54, 56, 58, 60, 62, 64, 66, 68, 70, 72, 74, 76, 78 or 80, followed by G; Cat. Nos. 2217R1, 2217S1, followed by 02 thru 20, followed by T or G; Cat. Nos. 2217R2, 2217S2, followed by 02, 04, 06, 08, 10, 12, 14, 16, 18, 20, 22, 24, 26, 28, 30, 32, 34, 36, 38 or 40, followed by T or G; Cat. No. 2316, followed by SM, R or S, followed by 06, 08, 10, 12, 14, 16, 20, 24, 26, 30, 34 or 40, followed by G, T or SG; Cat. Nos. 4409AP, 4409A, 4409, 4409SM, followed by 04, 06, 08, 10, 12, 14, 16, 18, 20, 22, 24 or 26.

Low voltage connectors, Cat. No. 2350SM-02.

Cat. No. 225SM followed by 20, followed by 01; Cat. No. 1226 followed by 30, followed by 02 or 03; Cat. No. 1254SMB followed by 10, 20, 30 or 40; Cat. Nos. 1394S-06, 1394R-06; Cat. No. 1394SM followed by 04; Cat. No. 1394UR followed by 06; Cat. No. 1500 followed by S or R, followed by 2 thru 10; Cat. No. 2000P, followed by 14G, 20G, 30G, 32G, 36G, 40G or 50G, followed by 233; Cat. No. 2001S, followed by 14G, 20G, 30G, 32G, 36G, 40G or 50G, followed by 220; Cat. No. 2212BR followed by 30, followed by G or T; Cat. No. 2212SM followed by 40G, followed by 75; Cat. No. 2214SM followed by 70G, followed by 75; Cat. No. 2214BR followed by 26, followed by G or T; Cat. No. 2214DS followed by 20, followed by 66; Cat. No. 2214TB followed by 2, 4, 6, 8, 10, 12, 14, 16, 18 or 20; Cat. No. 2214113 followed by 64G, followed by 1A, 1B, 2B, 3B, 1C, 2C, 3C or 4C; Cat. No. 2227P followed by 20S, 24G, 28G

32G, followed by 03 or 06; Cat. No. 2228P followed by 2 thru 10; Cat. No. 2234S followed by 96; Cat. No. 2316113 followed by 64G, followed by A, B or C; Cat. No. 231682-3404 followed by 001 thru 006; Cat. No. 2317 followed by SD or RD, followed by 2, 3, 4, 5, 6, 7, 8, 9, 10, 11, 12, 13, 14, 15 or 16; Cat. No. 2325 followed by 18/36, 20/40, 22/44, 28/56, 30/60, 36/72, 40/80, 43/86 or 50/100, followed by L1 or L2; Cat. No. 2392-5100; Cat. No. 2400SM followed by 02, 03 or 04, maybe followed by T1, T2 or T3; Cat. No. 2417 followed by SJ or RJ, followed by 10, 12, 14, 16, 18, 20, 22, 24, 26, 28, 30 or 32, followed by PHD; Cat. No. 2425 followed by 40, 44, 56, 60, 86 or 100, followed by L1 or L2; Cat. No. 2525 followed by 200; Cat. No. 2526-242-SLOT1; Cat. No. 2710-06 followed by one alphanumeric digit; Cat. No. 4110SM followed by 07, followed by A1, A2 or A3, followed by M; Cat. No. 4120SM followed by 09; Cat. No. 4130SM followed by 10; Cat. Nos. 5075BMR-04-SM, 5075BMR-05-SM, 5075AMR1-04-SM; Cat. No. 5075BS followed by 04, followed by WH; Cat. No. 5075AUR followed by 04; Cat. Nos. 5075ARP-04, 5075ARP-04-SMD; Cat. No. 5198 followed by S or R, followed by 2 thru 10; Cat. No. 6604SB followed by 40WR; Cat. No. 6801S followed by 50, followed by 70; Cat. No. 6831S followed by 40; Cat. No. 7520SL followed by 50P, followed by A, B, C or D; Cat. No. 7520 followed by 50P, followed by T1B3; Cat. Nos. ICA-501-006, ICA-501-008.

Cat. No. 1320H followed by 02 thru 12; Cat. No. 5560 followed by 02, 04, 06, 08, 10, 12, 14, 16 or 18; Cat. No. 5561 followed by 02, 04, 06, 08, 10, 12, 14, 16 or 18; Cat. No. 5561S followed by 02, 04, 06, 08, 10, 12, 14, 16, 18; Cat. No. 5561S followed by 02, 04, 06, 08, 10, 12, 14, 16 or 18, followed by T, followed by SM or SM1; Cat. No. 5561R followed by 02, 04, 06, 08, 10, 12, 14, 16, 18; Cat. No. 5561R followed by 02, 04, 06, 08, 10, 12, 14, 16 or 18, followed by T, followed by SM, SM1 or SM2; Cat. No. 9200P followed by 4B, 6, 9, 12 or 15; Cat. No. 9200R followed by 4B, 6, 9, 12 or 15; Cat. No. 9635P, followed by 09, 12 or 15; Cat. No. 9635R followed by 09, 12 or 15; Cat. No. 2363P followed by 01, 02, 06, 04, 05, 06, 09, 12 or 15, followed by A, followed by 01 or blank; Cat. No. 2363R followed by 01, 02, 06, 04, 05, 06, 09, 12 or 15, followed by A, followed by 01; Cat. Nos. 2650P-08, 2650R-08.

Cat. No. 1320H, followed by 02 thru 12; Cat. No. 5560, followed by 02, 04, 06, 08, 10, 12, 14, 16 or 18; Cat. No. 5561, followed by 02, 04, 06, 08, 10, 12, 14, 16 or 18; Cat. No. 5561S, followed by 02, 04, 06, 08, 10, 12, 14, 16, 18; Cat. No. 5561S, followed by 02, 04, 06, 08, 10, 12, 14, 16 or 18, followed by T, followed by SM or SM1; Cat. No. 5561R, followed by 02, 04, 06, 08, 10, 12, 14, 16, 18; Cat. No. 5561R, followed by 02, 04, 06, 08, 10, 12, 14, 16 or 18, followed by T, followed by SM, SM1 or SM2; Cat. No. 9200P, followed by 4B, 6, 9, 12 or 15; Cat. No. 9200R, followed by 4B, 6, 9, 12 or 15; Cat. No. 9635P, followed by 09, 12 or 15; Cat. No. 9635R, followed by 09, 12 or 15; Cat. No. 2363P, followed by 01, 02, 06, 04, 05, 06, 09, 12 or 15, followed by A, followed by 01 or blank; Cat. No. 2363R, followed by 01, 02, 06, 04, 05, 06, 09, 12 or 15, followed by A, followed by 01; Cat. Nos. 2650P-08, 2650R-08.

Connectors, Cat. No. 1253H, followed by 02 thru 16, 18, 20, 22, 24, 26, 28 or 30; Cat. Nos. 1254HA, 1254RA, 1254SA and 2114H, followed by 02 thru 15; Cat. No. 1254HB, followed by 10, 20, 30 or 40; Cat. No. 1255H, followed by 02 thru 10, 12, 20, 25 or 30; Cat. No. 1600H and 2220H, followed by 02 thru 20; Cat. No. 1600HB and 1600RMB, followed by 20, 30, 40 or 50; Cat. No. 1600SMB, followed by 12, 14, 16, 18, 20, 22, 24, 26, 28, 30, 40 or 50, followed by CR or blank; Cat. No. 1602H, followed by 08, 14, 20 or 30; Cat. Nos. 2004P and 2004S, followed by 10, 14, 16, 20, 24, 26, 30, 32, 34, 36, 40, 46, 50, 60, 70 or 80, followed by G; Cat. Nos. 2005P and 2005S, followed by 31 or 41; Cat. Nos. 2010 and 2011, followed by 10, 12, 14, 16, 18, 20, 22, 24, 26, 28, 30, 32, 34, 36, 38, 40, 50, 60, 68, 70, 80, 90, followed by G; Cat. Nos. 2065P and 2065S, followed by 10, 20, 30, 40, 50 or 52, followed by G; Cat. Nos. 2199RA and 2199SA, followed by 02 thru 50, followed by G; Cat. Nos. 2199R0 and 2199R5, followed by 02, 04, 06, 08, 10, 12, 14, 16, 18, 20, 22, 24, 26, 28, 30, 32, 34, 36, 38, 40, 42, 44, 46, 48, 50, 52, 54, 56, 58, 60, 62, 64, 66, 68, 70, 72, 74, 76, 78, 80, 82, 84, 86, 88, 90, 92, 94, 96, 98 or 100, followed by G; Cat. Nos. 2199SB and 2200SB, followed by 04, 06, 08, 10, 12, 14, 16, 18, 20, 22, 24, 26, 28, 30, 32, 34, 36, 38, 40, 42, 44, 46, 48, 50, 52, 54, 56, 58, 60, 62, 64, 66, 68, 70, 72, 74, 76, 78, 80, 82, 84, 86, 88, 90, 92, 94, 96, 98, 100, followed by G; Cat. No. 2207SM, followed by 04, 06, 08, 10, 12, 14, 16, 18, 20, 22, 24, 26, 28, 30, 32, 34, 36, 38, 40, 42, 44, 46, 48, 50, 52, 54, 56, 58, 60, 62, 64, 66, 68, 70, 72, 74, 76, 78 or 80, followed by G; Cat. No. 2211, followed by DI or SM, followed by 02 thru 40, followed by G, T or SG; Cat. No. 2212111, followed by 02 thru 40, followed by G, followed by 1A, 1B, 1C, 2B, 2C, 3B, 3C or 4C; Cat. Nos. 2212R and 2212TB, followed by 02 thru 40, followed by G, SG or T; Cat. No. 2801SM, followed by 02 thru 05, followed by G; Cat. Nos. 5560A and 5561A, followed by 02 thru 12; Cat. No. 4409AS, followed by 04, 06, 08, 10, 12, 14, 16, 18, 20, 22, 24 and 26; Cat. No. 5075ABMR, followed by 05, followed by SM or SM1; Cat. No. 5198H, followed by 02 thru 10; Cat. No. 5289, followed by R or S, followed by 02 thru 12; Cat. No. 5504F1RS, followed by 09, 15, 25 or 37, followed by S; Cat. Nos. 5513P-13W3, 5513S-13W3, 5514P-13W3, 5514S-13W3, 5515P-13W3 and 5515S-13W3; Cat. Nos. 5518R-24-1M15, 5518R-24-5M15, 5518S-24-5M15; Cat. No. 6604PB, followed by 04, 06, 08, 10, 12, 14, 16, 18, 20, 22, 24, 26, 28, 30, 32, 34, 36, 38, 40, 42, 44, 46, 48, 50, 52, 54, 56, 58, 60, 62, 64, 66, 68, 70, 72, 74, 76, 78 or 80, followed by G or T; Cat. Nos. 6803S and 6832S, followed by 04, 06, 08, 10, 12, 14, 16, 18, 20, 22, 24, 26, 28, 30, 32, 34, 36, 38, 40, 42, 44, 46, 48, 50, 52, 54, 56, 58, 60, 62, 64, 66, 68, 70, 72, 74, 76, 78 or 80, followed by G, SG or T; Cat. Nos. 6831S and 7801R, followed by 02 thru 40; Cat. No. 6833S, followed by 04, 06, 08, 10, 12, 14, 16, 18, 20, 22, 24, 26, 28, 30, 32, 34, 36, 38, 40, 42, 44, 46, 48, 50, 52, 54, 56, 58, 60, 62, 64, 66, 68, 70, 72, 74, 76, 78 or 80; Cat. No. 6850, followed by R, S or SM, followed by 02 thru 50, followed by G or T; Cat. No. 6852, followed by R1 or S1, followed by 04, 06, 08, 10, 12, 14, 16, 18, 20, 22, 24, 26, 28, 30, 32, 34, 36, 38, 40, 42, 44, 46, 48, 50, 52, 54, 56, 58, 60, 62, 64, 66, 68, 70, 72, 74, 76, 78 or 80, followed by G or T; Cat. No. 6853, followed by R1 or S1, followed by 04, 06, 08, 10, 12, 14, 16, 18, 20, 22, 24, 26, 28, 30, 32, 34, 36, 38, 40, 42, 44, 46, 48, 50, 52, 54, 56, 58, 60, 62, 64, 66, 68, 70, 72, 74, 76, 78 or 80; Cat. No. 8982R, followed by 02 thru 04.

NELTRON

Marking: Company name or trademark

and catalog or model designation.

[Last Updated](#) on 2008-02-01

[Questions?](#)[Notice of Disclaimer](#)[Page Top](#)[Copyright © 2008 Underwriters Laboratories Inc.®](#)

The appearance of a company's name or product in this database does not in itself assure that products so identified have been manufactured under UL's Follow-Up Service. Only those products bearing the UL Mark should be considered to be Listed and covered under UL's Follow-Up Service. Always look for the Mark on the product.

UL permits the reproduction of the material contained in the Online Certification Directory subject to the following conditions: 1. The Guide Information, Designs and/or Listings (files) must be presented in their entirety and in a non-misleading manner, without any manipulation of the data (or drawings). 2. The statement "Reprinted from the Online Certifications Directory with permission from Underwriters Laboratories Inc." must appear adjacent to the extracted material. In addition, the reprinted material must include a copyright notice in the following format: "Copyright © 2008 Underwriters Laboratories Inc.®"

[www.DataSheet4U.com](#)[www.DataSheet4U.com](#)