

Oberheim®



GM-1000



24 BIT DIGITAL SIGNAL PROCESSOR



OPERATING MANUAL

viscount® JOINT VENTURE



	This symbol is intended to alert the user to the presence of important operating and maintenance (servicing) instructions in the literature accompanying the appliance.		This symbol is intended to alert the user to the presence of uninsulated "dangerous voltage" within the product's enclosure that may be of sufficient magnitude to constitute a risk of electronic shock to persons.
---	---	---	--

"INSTRUCTIONS PERTAINING TO A RISK OF FIRE, ELECTRIC SHOCK, OR INJURY TO PERSONS" IMPORTANT SAFETY INSTRUCTIONS

WARNING: When using electric products, basic precautions should always be followed, including the following:

- 1) Read all instructions before using the product.
- 2) To reduce risk of injury, close supervision is necessary when product is used near children.
- 3) Do not place this product near water – for example, near a bathtub, washbowl, kitchen sink, in a wet basement, or near a swimming pool, or the like.
- 4) This product, either alone or in combination with an amplifier and headphones or speakers, may be capable of producing sound levels that could cause permanent hearing loss. Do not operate for a long period of time in high volume level or at a level that is uncomfortable. If you experience any hearing loss or ringing in the ears, you should consult an audiologist.
- 5) This product should be located away from heat sources such as radiators, heat register, or other products that produce heat.
- 6) The power supply cord of the instrument should be unplugged from the outlet when left unused for a long period of time.
- 7) Care should be taken so that objects do not fall and liquids are not spilled into the enclosure of the instrument.
- 8) The product should be serviced by qualified personnel when:
 - a. The power supply cord or the plug has been damaged; or
 - b. Objects have fallen, or liquid has been spilled into the product; or
 - c. The product has been exposed to rain; or
 - d. The product does not appear to operate normally or exhibit a marked change in performance; or
 - e. The product has been dropped, or the enclosure damaged.
- 9) Do not attempt to service the product beyond that described in the user-maintenance instructions. All other servicing should be referred to qualified personnel.

CONTENTS

1. Introduction

1.1 Precautions	page 81
-----------------------	---------

2. Description of controls and connectors

2.1 Front panel	page 82
2.2 Rear panel	page 83

3. Installation and instructions for use

3.1 Connection examples	page 84
3.2 Some advice about correct use of the GM 1000	page 85
3.3 Structure of the GM 1000	page 86

4. Play mode

4.1 Keys and controls	page 88
4.2 Selecting a memorized patch	page 89
4.3 Programming	page 89

5. Edit mode

5.1 Keys and controls	page 91
5.2 Master level	page 93
5.3 Memorizing a patch	page 94

6. Effects:

6.1 Compressor (CMP)	page 95
6.2 Distortion (DST)	page 101
6.3 Equalizer (EQ)	page 103
6.4 Amp simulator (AMP)	page 107
6.5 Modulation (MOD)	page 109
6.6 Special effects 1 (SP1)	page 114
6.7 Special effects 2 (SP2)	page 119
6.8 Delay (DLY)	page 125
6.9 Reverberation (REV)	page 132
6.10 Noise gate (NG)	page 140
6.11 The Midi Foot Controller	page 140

OBERHEIM GM 1000
Digital Signal Processor

7. Utility Mode:

7.1 Midi Settings.....	page 142
7.2 Program Table	page 144
7.3 Dump	page 144
7.4 Midi Monitor	page 145

8.Tools

8.1 Tuner	page 146
8.2 Analyzer	page 147

9. Tips and Tricks

9.1 Level and digital technology	page 150
9.2 Programming.....	page 151
9.3 Writing the patches.....	page 151

10 Initialization procedure:

10.1 Factory settings	page 153
10.2 Dsp self-test	page 153

11. Annex:

11.1 The types of connectos used.....	page 154
11.2 Glossary of terms used.....	page 154

12. Technical specifications	page 155
---	-----------------

1. INTRODUCTION

1.1 PRECAUTIONS

The following is a list of a number of simple precautions to be adopted when using and maintaining the instrument in order to avoid damage to its mechanical and electronic structures:

- To avoid the risk of electric shock, never make the connections or use the instrument with wet hands.
- Never apply excessive force to the instrument's mechanical parts and keys.
- Do not stress the instrument in transit or during use.
- Do not place the instrument close to heat sources, in excessively damp or dusty places or close to strong magnetic fields.
- When possible, do not place the instrument close to units which generate strong interference, such as radio and TV sets, monitors, etc.
- Never insert foreign bodies or liquids of any kind inside the instrument, for any reason.
- Never use solvents on the instrument's finishes. To clean, use only a soft cloth dipped in water.
- The inside of the instrument does not contain any parts requiring maintenance by the user. Never attempt to carry out repairs or modifications to the instrument; always contact qualified personnel for any repairs.
- Only connect foot-switches with normally open contact. Prolonged use of unsuitable pedal units causes serious damage to the instrument's electronic components.
- Use the power supply lead supplied or an equivalent with earth. Never use the instrument unless it is connected to an adequate earth connection. Before making the connection, check that the mains voltage is as indicated on the body of the adaptor.
- Disconnect the power supply lead from the mains socket if the instrument is to be out of use for long periods.

OBERHEIM GM 1000

Digital Signal Processor

2. DESCRIPTION OF CONTROLS AND CONNECTORS

2.1 FRONT PANEL

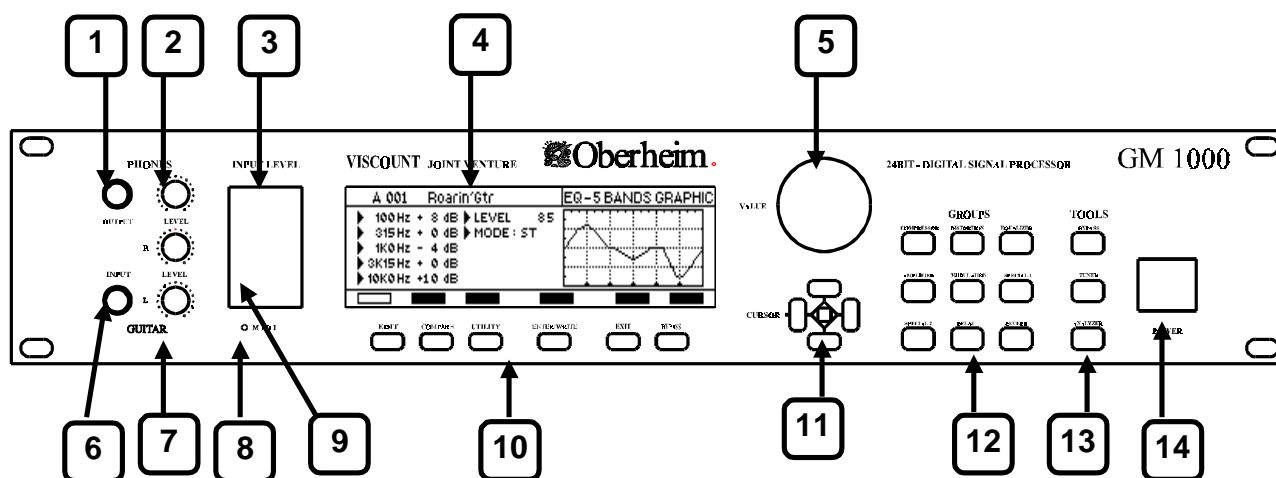

1. **Phones Output:** this socket is a headphones output which allows the GM 1000 to be used even without connection to an amplification system.
2. **Phones Level:** used to regulate the volume of the signal sent to the PHONES OUTPUT.
3. **Input Level:** LED indicator for the input signal level.
4. **Display:** backlit display used to display various information, such as the number and name of the memory to be used, the programming parameters, the sound spectrum analysis data, etc.
5. **Value:** data input device which can be used to vary the values selected using the cursor keys. Turn clockwise to increase the selected value or anti-clockwise to decrease.
6. **Guitar Input:** dedicated input connector for a guitar.
7. **Input Level:** regulates the amount of signal supplied as input to the GM 1000. The setting applies to both the front and rear connectors.
8. **Midi message:** light indicating that the rear Midi In connectors are receiving midi messages.
9. **Lcd Contrast:** regulates the contrast of the liquid crystal display (LCD).
10. **Function keys:** keys which allow the user to carry out the main functions necessary for use and programming of the GM 1000.
11. **Cursor:** the four illuminated green keys allow the user to move the cursor around the display in order to select a parameter for modification.
12. **Group keys:** keys used for selecting the groups which make up the sound processing chain.
13. **Tools keys:** these keys allow access to the Bypass, tuner and spectrum analyzer functions implemented in the GM 1000.
14. **Power key:** key used for switching the instrument on and off.

OBERHEIM GM 1000

Digital Signal Processor

2.2 REAR PANEL

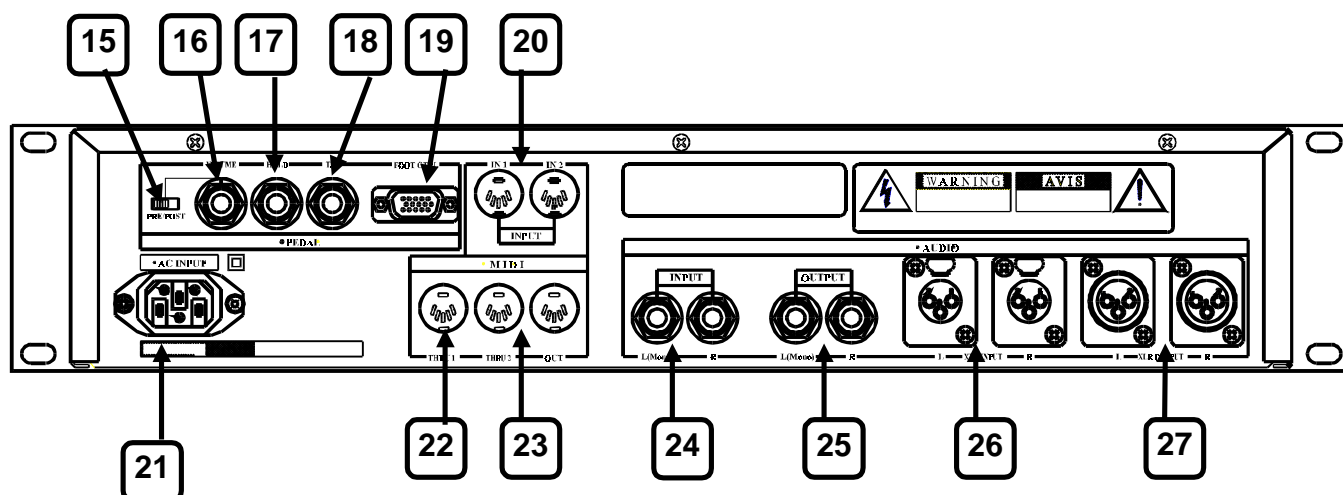

15. **Pre-Post switch:** selects where the volume control intervenes.
16. **Volume connector:** connector for connection of a volume pedal.
17. **Hold Switch:** jack for connection of an optional foot-switch which activates the hold delay function (infinite repetition of a memorized phrase).
18. **Tap Switch:** jack for connection of an optional foot-switch allowing the tap delay speed to be set.
19. **Foot Controller:** connector for connection of the optional Oberheim FC 3000 foot controller.
20. **Midi In 1 and 2:** five pin DIN connectors for reception of Midi messages from a remote Midi source.
21. **Ac Input:** connector for connection of the power supply lead supplied with the instrument.
22. **Midi Thru 1 and 2:** five pin DIN connectors which retransmits the MIDI codes as output exactly as they are received by the Midi In connectors. Used to create a chain of Midi devices.
23. **Midi Out:** five pin DIN connector for transmission of Midi messages generated by the GM 1000.
24. **L/Mono - R Input:** jacks for connection of a remote source to the GM 1000. There is a choice between a stereo connection, using the two inputs simultaneously (the recommended option) and a mono connection using the L/Mono connector only. The front Guitar Input connector has precedence over the rear Input connectors. These connectors are of unbalanced type.
25. **L/Mono - R Output:** the signal processed by the GM 1000 leaves the instrument from these two jacks. There is a choice between a stereo connection, using the two inputs simultaneously (the recommended option) and a mono connection using the L/Mono connector only. These connectors are of unbalanced type.
26. **L - R XLR Input:** balanced Cannon XLR connections for connection of a remote source to the GM 1000. Use this connectors in a stereo configuration
27. **L - R XLR Output:** the signal processed by the GM 1000 leaves the instrument from these two balanced Cannon XLR connectors. Use this connectors in a stereo configuration

OBERHEIM GM 1000
Digital Signal Processor

3. INSTALLATION AND INSTRUCTIONS FOR USE

3.1 CONNECTION EXAMPLES

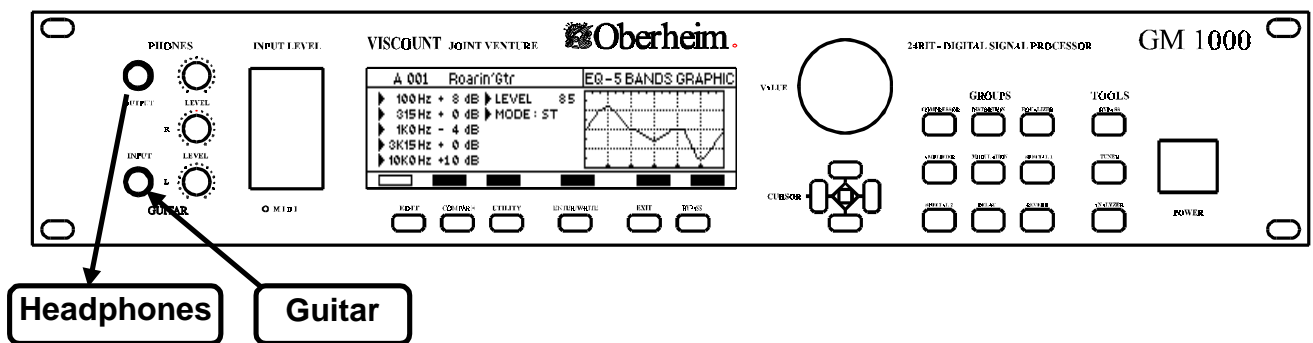
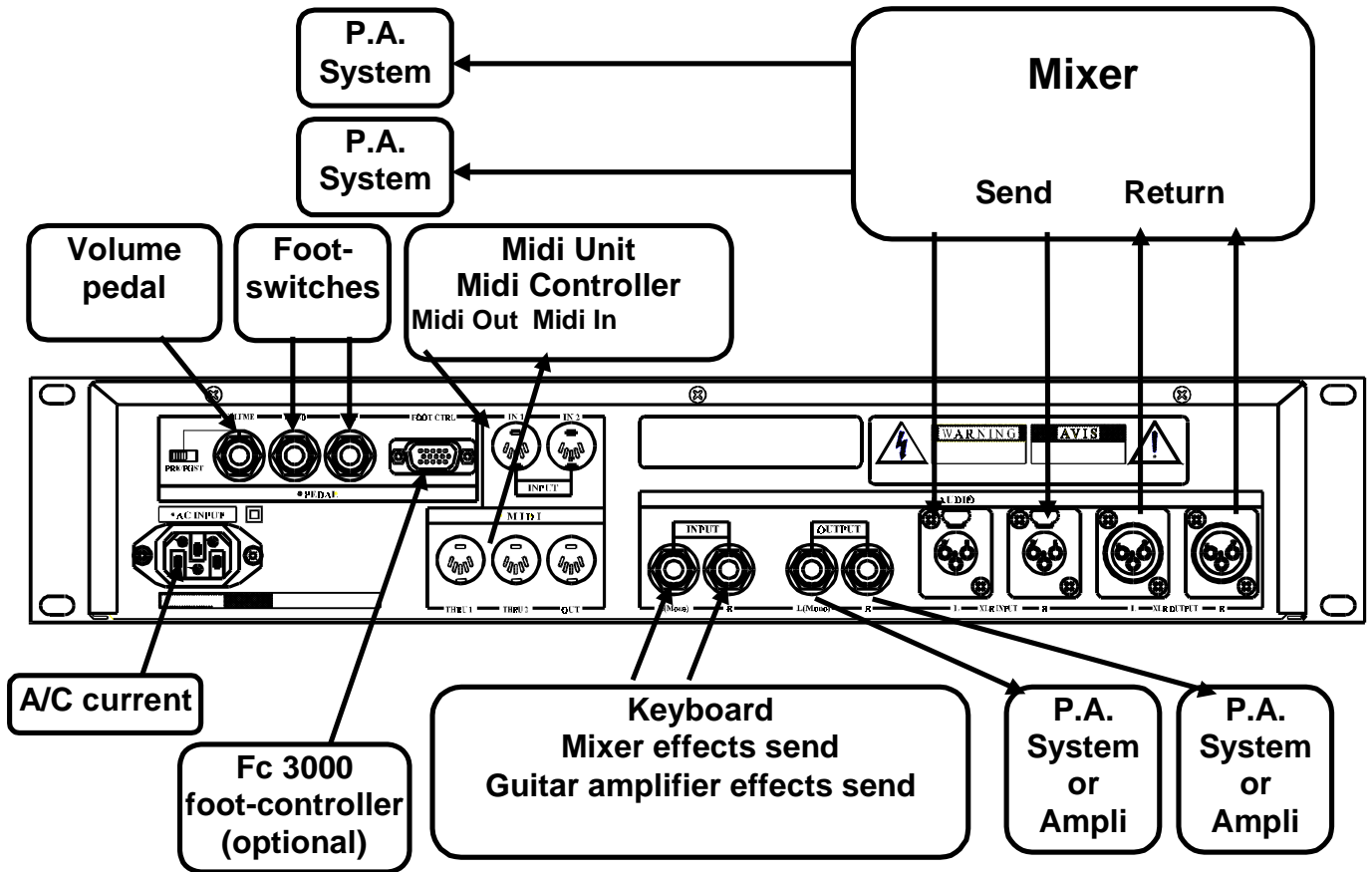

Audio connections:

- use only good quality screened cables.
- make the audio connections first and then the mains connection.

3.2 SOME ADVICE ABOUT CORRECT USE OF THE GM 1000

Switch-on.

Before making all the connections make sure that the amplification system volume is turned down to the minimum setting. Switch on the GM 1000 and then adjust the system volume again. Otherwise, always switch on the GM 1000 first and then the amplification system.

Input level.

Each instrument has its own output level which may vary depending on circumstances. In order to obtain the best performance from the GM 1000, the input level must be adjusted to suit the instrument connected. This simple procedure will ensure that the right amount of signal is sent to the effects processor in order to avoid distortion if the signal is too strong or hissing if the signal is too weak.

Start the operation by turning the input trimmers to zero and send a signal to the GM 1000. Start to turn the Input trimmers clockwise until the signal illuminates the Input Level LED meter; the optimum operating range is between -12 dB and -3 dB.

Output level.

The MASTER LEVEL (general output level) shown on the main video page must be regulated in the same way as the input level in order to adapt the output volume to that of the equipment connected to the OUTPUT(S). Since this parameter can also be memorized, more details of how it operates will be described in later sections.

Digital technology and levels.

The GM 1000 is an all-digital instrument: this means that some simple rules have to be followed during programming. In the digital technology, the maximum permitted dynamic threshold is 0 dB; above this level, even if it is only reached and exceeded for one moment, so-called digital distortion is created. Digital distortion has nothing to do with the distortion often required by guitarists, and generates an extremely unpleasant effect often mistakenly thought to be a real malfunction of the equipment. Since the GM 1000 is equipped with filters with an operating range of +/- 14 dB and it is possible to add together the action of a number of filters operating simultaneously, the threshold of 0 dB may be exceeded. This must therefore be borne in mind when programming the GM 1000, with frequent checks on the amplification gain introduced by the filters mentioned above by means of the bypass functions described in the PLAY MODE and EDIT MODE sections.

Adjusting the display contrast.

The GM 1000 is equipped with a large backlit LCD (liquid crystal display). In view of the characteristics of the LCD system, the contrast has to be adjusted to suit the angle from

OBERHEIM GM 1000

Digital Signal Processor

which the operator looks at it. A trimmer marked CONTRAST on the left of the panel is provided for this purpose.

3.3 STRUCTURE OF THE GM 1000

Memory configuration.

The memory of the GM 1000 is divided into four banks: A, B, C and D.

Each of them contains 128 memory locations (which from now on we will call patches), giving a total of 512. They are all at the disposal of the user, who can program them as preferred.

The original factory programming settings for the 128 patches in bank A are maintained permanently in a separate memory and can be recalled at any moment using a special procedure described in point 8.1 FACTORY SETTINGS.

Groups and effects.

The GM 1000 is designed to process the signal with up to 9 EFFECTS which can be programmed at any one time. In addition, there is also a constantly active, programmable Noise Gate (NG).

The effects are obtained by means of more than forty algorithms and are arranged into categories or GROUPS.

Each group is able to contain up to 6 different effects of the user's choice, and only one of them can be made active. There are 9 groups available, and this gives the maximum number of effects which can be used simultaneously (plus the noise gate, which is always active):

- COMPRESSOR (CMP): Compressor, Limiter, Expander, DeEsser-Ducker, Frequency Selective Expander/Gate, Dynamic Processor.
- DISTORTER (DST): Distortion, Overdrive, Crunch.
- EQUALIZER (EQ): 10 Bands Graphic EQ, Mono Parametric, Guitar, 5 Bands Graphic, Stereo Parametric.
- AMP SIMULATOR (AMP): Guitar, Bass.
- MODULATION (MOD): Chorus, Flanger, Phaser, Step Phaser, Tremolo, Vibrato.
- SPECIAL EFFECTS 1 (SP1): Wha-Wha, Comb Filter, Double Chorus, Ring Modulate, Auto Pan, Fade In.
- SPECIAL EFFECTS 2 (SP2): Shifting Delay, 3 Voice Pitch Shifter, Custom Shift, 4 Voice Chorus, Rotary Speaker, Denoiser.
- DELAY (DLY): Standard Delay, Tap Delay, Stereo Delay, Multi Delay, Metronome 1 Delay, Metronome 2 Delay.
- REVERB (REV): Reverb, Gate Reverb, Virtual Chamber.

This can all be summed up by a simple chart:

OBERHEIM GM 1000 Digital Signal Processor

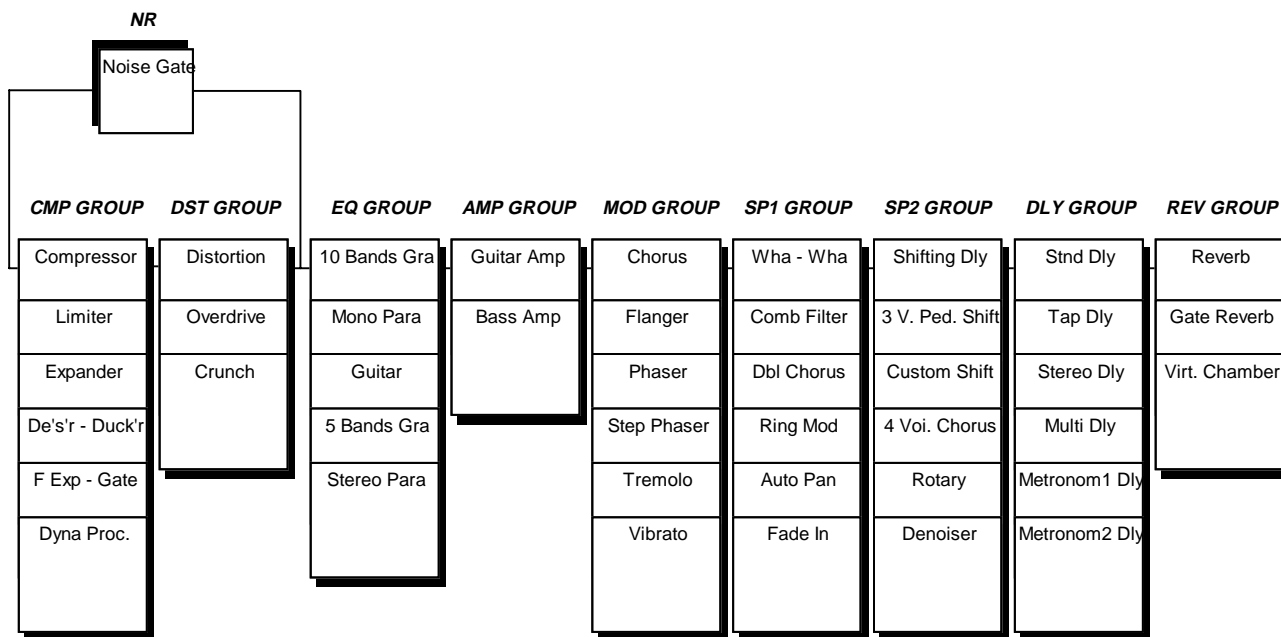

OBERHEIM GM 1000
Digital Signal Processor**4. PLAY MODE**

The section which follows will describe the PLAY MODE: we will discuss the way in which the GM 1000 will be used while the patches are being played. The next section, entitled EDIT MODE, will describe the procedure for programming a patch. This section will refer almost only to the main display page.

4.1 KEYS AND CONTROLS**Cursor.**

Four green illuminated keys to the right of the display and below the Value Encoder are called CURSOR keys. They allow the user to move the cursor, used to select a parameter to be modified, around the display. The top key moves the cursor upwards, the key on the right moves the cursor to the right, and so on.

Value.

Once the parameter to be modified has been selected, the Value Encoder allows the user to vary its value. Turn the knob clockwise to increase the selected value or anti-clockwise to decrease. The encoder works dynamically; in other words, the speed at which it is turned establishes the speed at which the selected value is varied.

General bypass.

To listen to the signal exactly as it reaches the INPUT socket, the user can completely bypass the algorithms which process the signal by pressing the BYPASS key. To confirm this operation, the light in the BYPASS key will illuminate. Press the BYPASS key again to return to the initial conditions. This type of bypass is referred to as a GENERAL BYPASS to distinguish it from the LOCAL BYPASS to be described in the EDIT MODE section.

Phones output.

This socket allows the user to listen to the results of the GM 1000 signal processing on headphones. Once the jack has been connected to the PHONES OUTPUT socket on the left of the panel, optimize the playback volume as preferred using the PHONES LEVEL trimmer immediately above the PHONES OUTPUT socket.

- **CAUTION !!** : *Excessively high playing volumes may seriously damage your hearing: keep the volume within reasonable limits.*

4.2 SELECTING A MEMORIZED PATCH

Changing the memory bank.

To select a memory bank other than the one which is active:

- Locate the cursor on the memory bank indication using the CURSOR keys.
- Turn the VALUE encoder until the required memory bank is displayed.

Changing the memory patch.

To select a memory patch other than the one which is active:

- Locate the cursor on the memory patch indication using the CURSOR keys.
- Turn the VALUE encoder until the required memory patch is displayed.

Master level.

The MASTER LEVEL parameter controls the general output level of the selected memory patch: the setting is memorized together with the patch itself. Note that this level is not an absolute value but depends on the settings made during programming of the individual groups active.

To modify the MASTER LEVEL value.

- Use the CURSOR keys to locate the flashing cursor on the MASTER LEVEL parameter.
- Turn the VALUE encoder until a playback volume suitable to requirements is obtained.
- **CAUTION !!:** an **E** displayed on the right of the words "play mode" indicates that this modification has not been memorized in the patch. To make the modification permanent, refer to point 5.3 MEMORIZING A PATCH in the EDIT MODE section.

4.3 PROGRAMMING

In PLAY MODE "programming" refers to the operations which can be performed on the instrument without necessarily having to carry out a complex session with substantial modification of the processing parameters, for which the EDIT MODE is required.

The Group levels.

Press the COMPARE key with the main video page on the screen to access the video page which allows the levels of each individual group to be adjusted.

These parameters regulate the way in which the active groups affect the signal to be processed. The active groups are those which have been included in the processing chain during the programming phase and are not in OFF or LOCAL BYPASS status (the LOCAL BYPASS status is different from the GENERAL BYPASS already discussed and will be described in the EDIT MODE section).

- **N.B.:** the level of a group in local bypass or OFF status can be modified, but this will have no effect on the signal.

OBERHEIM GM 1000

Digital Signal Processor

The parameter modified consists of the effect send level (EFFECT LEVEL - see section 6. EFFECTS for further information) and allows the user to set the influence of the specific group within the processing chain, with values between 0 and 100. The only exception is the DST group, which does not include parameters for which there is differentiation between the level of the direct signal and that of the processed signal: in this case, the parameter controlled (the only one with values between 0 and 64) will be the DRIVE (distortion intensity) value, which is certainly the most significant parameter in the group concerned.

To modify the operating level of a group:

- Use the CURSOR keys to locate the flashing cursor on the group level to be modified.
- Turn the VALUE encoder until an effect suitable to requirements is obtained (it may be necessary to vary the values of more than one group to obtain the desired results).
- **CAUTION !!:** an **E** displayed on the right of the words "play mode" indicates that this modification has not been memorized in the patch. To make the modification permanent, refer to WRITE MODE in the EDIT MODE section.

Press the Exit key to return to the main menu page.

OBERHEIM GM 1000
Digital Signal Processor

5. EDIT MODE

The section which follows will describe the EDIT MODE operating method, or in other words we will discuss the way in which the GM 1000 will be used during programming of the patches. In EDIT MODE, the operator can carry out all the procedures relating to modification of the parameters connected to the programming of a patch. The procedure for saving a new or modified patch in one of the 512 locations available will also be explained.

5.1 KEYS AND CONTROLS

For use of the CURSOR keys and the VALUE encoder, see PLAY MODE section.

Edit and Exit keys.

The EDIT key gives access to the EDIT pages. Once the EDIT function has been accessed, this key allows the user to display pages after those shown on the display, in accordance with the instrument's structural hierarchy. The following is a simple example:

MAIN MENU PAGE

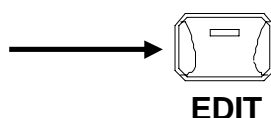

MAIN EDIT PAGE

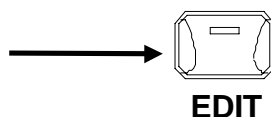

GROUP EDIT PAGE

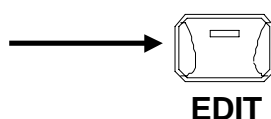

1° EFFECT EDIT PAGE

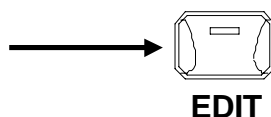

2° EFFECT EDIT PAGE (IF ANY)

The small rectangle on the display immediately above the EDIT key will show whether or not the EDIT function is available at that moment, on every video page.

- rectangle solid: function available.

OBERHEIM GM 1000

Digital Signal Processor

- rectangle empty: function not available.

Once the effect has been selected, if it has more than one EDIT page the word PAGE above the rectangle will indicate that the parameters which can be modified are spread over more than one page.

The EXIT key works in exactly the opposite way to the EDIT key: it allows the user to move one page back from the one shown on the display, passing through the hierarchical structure in the opposite direction to that explained for the EDIT key:

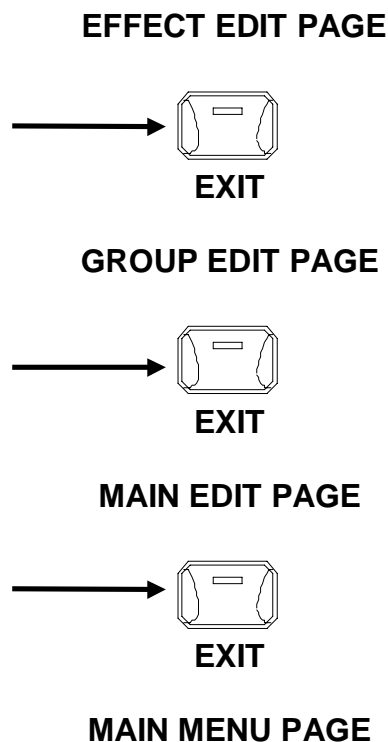

Enter/Write key.

This key activates the patch writing function (WRITE MODE) described later in point 5.3 MEMORIZING A PATCH.

There are also cases when this key assumes different functions. These will be displayed in line with the key itself on the LCD.

Bypass key (function keys).

The BYPASS key amongst the function keys also provides several functions, but in this case the procedure obtained depends on the video page on the screen:

- main video page: this key provides a GENERAL BYPASS of the entire chain of effects, or in other words allows the user to listen to the input signal unchanged.
- main edit video page: this key allows the user to choose between BYPASS (BYP) and ON status for the selected group.
- following edit pages: this key provides a LOCAL BYPASS, i.e. it switches the selected group only (e.g. DST or CMP) into BYPASS status.

OBERHEIM GM 1000

Digital Signal Processor

We will try to give a rapid explanation of the difference between these types of BYPASS and the types already seen, in order to prevent misunderstandings and allow operators to use the GM 1000 correctly. The LOCAL BYPASS function cuts out one group (e.g. DISTORTION, EQ or MODULATION), while the GENERAL BYPASS disables the entire chain of effects simultaneously. It must be underlined that the two types of BYPASS referred to here are temporary, unlike the BYPASS activated in the main edit video page, which will be memorized together with all the patch parameters. It should also be remembered that the OFF and BYPASS statuses in the main edit video page have the same result in terms of sound. The difference between these two values in practical terms becomes obvious when the optional Oberheim FC 3000 foot controller is used, since the foot switches it provides allow the user to switch any one of the groups set in BYPASS status to ON. On the other hand, the foot controller will have no effect on the groups in OFF status, which will be completely out of use.

Compare.

This key has two functions:

- in the main video page: in this case pressing the COMPARE key activates the EDIT page for the group levels already described in the PLAY MODE section. This function is underlined by the word "LEVELS" on the display against the COMPARE key. Press EXIT to return to the main video page.
- in the edit pages: it activates the sound compare function. In other words, it allows the user to make a comparison by alternating the sound modified in an EDIT session (current situation) with the sound memorized in a patch taken as the starting point for the modification process. It is used to check the worth of the new settings before saving them and replacing the original patch with the modified one. While the comparing procedure is in progress, the display will show: COMPARING - "COMPARE" TO QUIT. Press COMPARE again to exit from the function.
- CAUTION !!: an **E** to the right of "play mode" on the main menu page indicates that the GM 1000 patch has been modified. The modifications made become operational immediately but will not become permanent until a memorization procedure (described in point 5.3 MEMORIZING A PATCH of this same section) has been carried out. Otherwise they will be lost when a different memory location is selected.

5.2 MASTER LEVEL

When programming is complete, users are advised to adjust the MASTER LEVEL (general volume) parameter as appropriate to the output volume obtained from the sum of the processes carried out by the individual groups. The parameter is located in the main menu page, to allow rapid adjustments even during live performances while the multieffect device is in PLAY MODE, and the setting is memorized in the patch together with all the other parameters.

OBERHEIM GM 1000
Digital Signal Processor

5.3 MEMORIZING A PATCH

Press the ENTER/WRITE key with the key enabled (the corresponding rectangle on the display must be solid) to access the patch memorization function. The display will show the relative page, which shows:

- the current memory location (CURRENT LOCATION);
- the destination memory location (DESTINATION).

The GM 1000 automatically offers the current location.

To modify the bank and/or the location, use the CURSOR keys and the VALUE encoder. To change the name of the patch, press the flashing Utility (NAME) key to display, select the characters to be modified using the CURSOR keys and change them using the VALUE encoder. At this point press the ENTER/WRITE key again to memorization the patch in the destination memory location. A short message will confirm that the operation has been completed.

- **CAUTION !!:** *a modification to a patch can be memorized quickly by simply pressing the ENTER/WRITE key twice in succession.*

OBERHEIM GM 1000

Digital Signal Processor

6. EFFECTS

The chapter which follows describes all the effects in each group. In addition to a brief description of the characteristics of the effect itself, all the parameters relating to its programming will be discussed. All the procedures described start from the main edit video page.

To access the various programming pages, use the EDIT key, while the CURSOR keys and the VALUE encoder will always be used to modify parameters.

- **USEFUL HINT:** *When programming, always take care to make proper use of the BYPASS and COMPARE keys previously described in the EDIT MODE section.*

As stated in the introductory notes, only one effect can be selected from each group. The effect selected from the group can always be identified because it is the only one which flashes in the group edit page. To change the selected effect, locate the cursor on the name of the effect you require using the CURSOR keys and then press the EDIT key. We have emphasized this procedure because the fact that another effect is highlighted by the cursor might mislead you unless this operation is confirmed by pressing the EDIT key which will bring you to the effect edit page and which also confirms that the desired effect has been selected.

But now let's move on to examine the effects the GM 1000 is able to provide.

6.1 COMPRESSOR (CMP)

COMPRESSOR

The compressor is an effect which reduces the dynamic range of the original signal. Therefore if an "activation point" (threshold) is set for the compressor, the dynamics of all the signal below this threshold will be compressed: the result will be a more noticeable sound which can more easily be sustained over time (sustain effect).

After selecting the main edit page, locate the cursor below the CMP group and press the EDIT key. At this point, the EDIT page of the COMPRESSOR GROUP will appear:

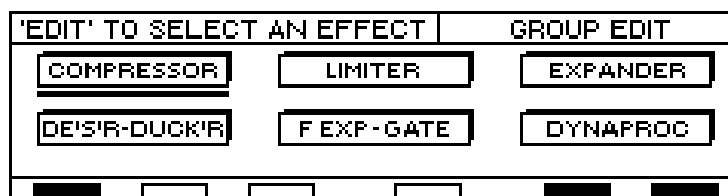

When the compressor group is selected and editing of the COMPRESSOR effect is activated, the following video page will appear on the display:

OBERHEIM GM 1000

Digital Signal Processor

A 001 Roarin'Gtr	CMP - COMPRESSOR
▶ RATIO 5:1	
▶ THRESHOLD ██████████	
▶ ATTACK █████	
▶ BRIGHT	
▶ LEVEL ██████████	
<input type="checkbox"/> <input type="checkbox"/> <input type="checkbox"/> <input type="checkbox"/> <input type="checkbox"/> <input type="checkbox"/>	

With the aid of the CURSOR keys and the ENCODER, the following parameters can be set:

Ratio parameter. Range 1:1, 1.2:1, 1.5:1, 2:1, 3:1, 5:1, 10:1, 20:1, ∞:1

This sets how much the dynamic range of the signal will be compressed on the basis of a directly proportional ratio. The compression ratio 1:1 (one to one) will not compress the signal, while if a value of 5:1 is set the output signal of this module will be compressed 5 times compared to the original.

Threshold parameter. Range: 0 - 45

Sets the level of the input signal below which the compression effect will operate.

Attack parameter. Range: 0 - 100

The attack parameter allows the user to set a delay in activation of the compression effect. It must be noted that an increase in the attack time corresponds to an increase in the sound sustain effect.

Bright parameter. Range: 0 - 5

This is an equalization targeting the medium-high tones, which help to make the sound emitted by the compressor more piercing and aggressive.

Level parameter. Range: 0 - 100

Regulates the general level of the compressor output.

LIMITER

As its name implies, the limiter limits the dynamics of the signal to a value which can be freely set by the user.

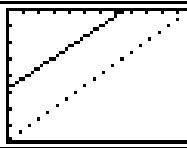
A 001 Roarin'Gtr	CMP - LIMITER
▶ THRESHOLD ██████████	
▶ RELEASE █████	
▶ LEVEL ██████████	
<input type="checkbox"/> <input type="checkbox"/> <input type="checkbox"/> <input type="checkbox"/> <input type="checkbox"/> <input type="checkbox"/>	

Threshold parameter. Range: 0 - 45

OBERHEIM GM 1000

Digital Signal Processor

Sets the value of the level of the input signal above which the limiter comes into operation. The range goes from -6 dB (Threshold = 0) to about -40 dB (Threshold = 45).

Release Time parameter. Range: 0 - 100

Sets the time for which the Limiter effect persists.

Level parameter. Range: 0 - 100

Regulates the level of the output signal in the context of the effects chain.

EXPANDER

In contrast with the Limiter, this effect expands the dynamic range.

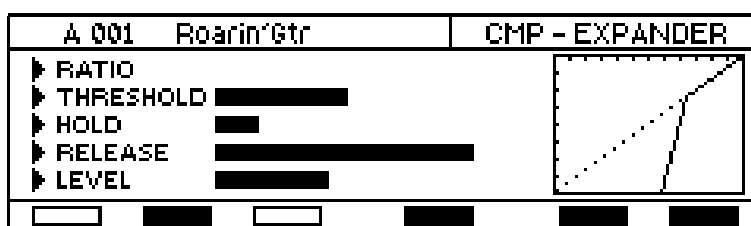

Ratio parameter. Range: 1:1, 1:1.5, 1:2, 1:2.5, 1:3

Sets the expansion ratio, from a minimum of 1:1 to a maximum of 1:5.

Threshold parameter. Range: 0 - 45

Sets the value of the level of the input signal below which the expansion effect comes into operation. The range goes from 0 (corresponding to a level of about -14 dB) to 45 (corresponding to a level of about -48 dB).

Hold Time parameter. Range: 0 - 100

Release Time parameter. Range: 0 - 100

These set the persistence and release time of the Expander effect.

Level parameter. Range: 0 - 100

Regulates the level of the output signal in the context of the effects chain.

DEESSER - DUCKER

This is a compressor without attenuation recovery.

The deesser function attenuates the hiss deriving from the pronunciation of the letter "s".

The Ducker function is obtained by controlling the compression of a signal in relation to the level of another. One typical example of the use of this effect is by radio broadcasters, where the volume of the music is automatically turned down when the presenter speaks into the microphone.

OBERHEIM GM 1000

Digital Signal Processor

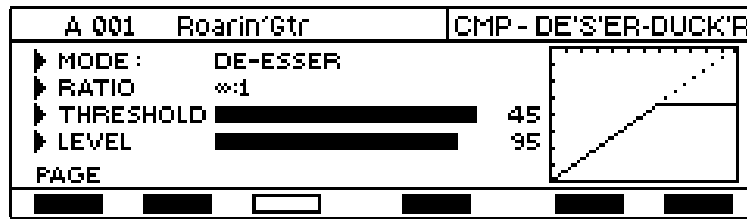

Mode parameter. Range: De-Esser, Ducker

Establishes which of the two functions available is to be used.

Threshold parameter. Range: 0 - 45

They set the value of the level of the input signal above which the compression comes into operation and the compression ratio.

Ratio parameter. Range 1:1, 1.2:1, 1.5:1, 2:1, 3:1, 5:1, 10:1, 20:1, ∞:1

Sets the compression ratio.

Level parameter. Range: 0 - 100

Regulates the level of the output signal in the context of the effects chain.

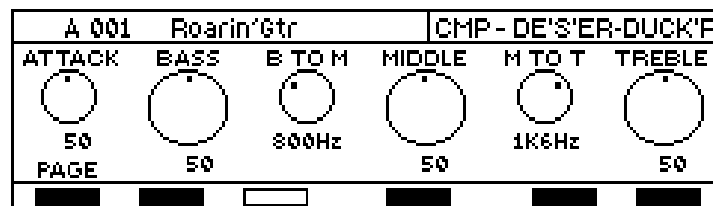

Attack parameter. Range: 0 - 100

Sets the time for which the compressor acts on the signal attack.

Bass parameter. Range: 0 - 100

Regulates the low section of the crossover.

"B to M" parameter. Range: 63, 80, 100, 125, 160, 200, 250, 320, 400, 500, 635, 800, 1k, 1k25, 1k6, 2k, 2k5, 3k2, 4k, 5k, 6k4, 8k, 10k, 12k8, 16k Hz

This parameter controls the crossover cut-off frequency on the medium-low frequencies.

Middle parameter. Range: 0 - 100

Regulates the central band of the crossover.

M to T parameter. Range: 63, 80, 100, 125, 160, 200, 250, 320, 400, 500, 635, 800, 1k, 1k25, 1k6, 2k, 2k5, 3k2, 4k, 5k, 6k4, 8k, 10k, 12k8, 16k Hz

This parameter controls the crossover cut-off frequency on the medium-high frequencies.

OBERHEIM GM 1000
Digital Signal Processor

Treble parameter. Range: 0 - 100

Regulates the high band of the crossover.

FREQUENCY SELECTIVE EXPANDER/GATE

This is an expander which allows the filtration of the control signal. The operating principle is the opposite of that explained in the section describing the Ducker effect. In view of the high maximum expansion ratio (1 : 4 1/2), it can also operate as a gate.

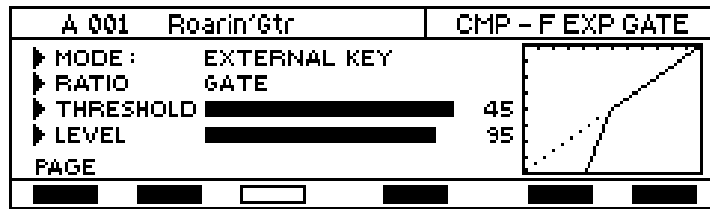

Mode parameter. Range: Freq. Selective Exp/Gate, Ext. Key Exp/Gate

Establishes whether the control signal is given by the sum of the left-hand and right-hand signals or only by the right-hand single. In the second case, the audio signal is the left-hand signal only.

Ratio parameter. Range: 1:1, 1:1.5, 1:2, 1:2.5, 1:3, 1:3.5, 1:4 Gate

Regulates the expansion ratio.

Threshold parameter. Range: 0 - 45

Sets the value of the level of the input signal below which the expansion effect comes into operation.

Level parameter. Range: 0 - 100

Regulates the level of the output signal in the context of the effects chain.

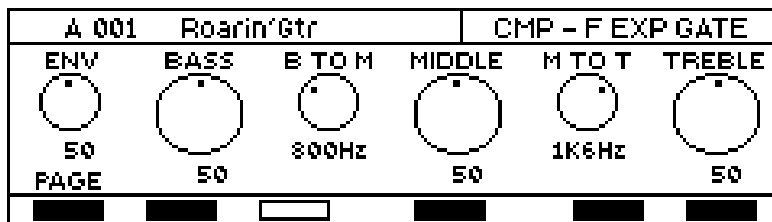

Env parameter. Range: 0 - 100

Regulates the hold and release times of the expander.

Bass Parameter. Range: 0 - 100

Middle Parameter. Range: 0 - 100

Treble Parameter. Range: 0 - 100

OBERHEIM GM 1000

Digital Signal Processor

B To M Parameter Range: 63, 80, 100, 125, 160, 200, 250, 320, 400, 500, 635, 800, 1k, 1k25, 1k6, 2k, 2k5, 3k2, 4k, 5k, 6k4, 8k, 10k, 12k8, 16k Hz

M To T Parameter Range: 63, 80, 100, 125, 160, 200, 250, 320, 400, 500, 635, 800, 1k, 1k25, 1k6, 2k, 2k5, 3k2, 4k, 5k, 6k4, 8k, 10k, 12k8, 16k Hz

These regulate the three sections of the crossover. The information given in the description of the DeEsser - Ducker applies.

DYNAMIC PROCESSOR

A dynamic spectral processor. This effect features a filter which allows the audio signal and/or the control signal to be modified in 6 different ways.

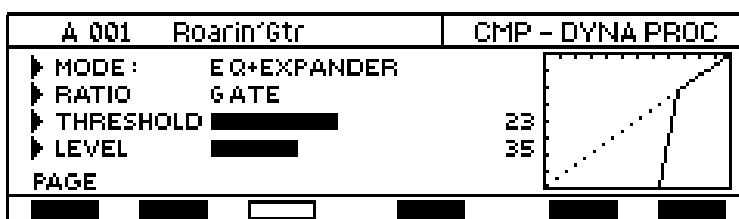

Mode parameter. Range: Dynamic Loudness, Spectral Compressor, Spectral DeEsser, Spectral Exp/Gate, Eq + Compressor, Eq + Expander.

Controls the mode in which the effect works. The functions provided by the modes vary quite widely.

- Dynamic Loudness: adds the frequencies selected to the crossover depending on the total level of the input signal.
- Spectral Compressor: compresses the frequencies selected in the crossover with attenuation recovery.
- Spectral DeEsser: compresses the frequencies selected in the crossover without attenuation recovery.
- Spectral Exp/Gate: expands the frequencies selected in the crossover.
- Eq + Compressor: combines the equalizer and the compressor.
- Eq + Expander: the combination of the equalizer and the expander/gate.

Ratio parameter. Range:

1:1, 1.2:1, 1.5:1, 2:1, 3:1, 5:1, 10:1, 20:1, ∞:1

or

1:1, 1:1.5, 1:2, 1:2.5, 1:3, 1:3.5, 1:4, Gate

depending on the Mode selected.

Sets the compression/expansion ratio.

Threshold parameter. Range: 0 - 45

Regulates the value of the level of the input signal above/below which the compression/expansion effect is activated.

Level parameter. Range: 0 - 100

Regulates the level of the output signal in the context of the effects chain.

OBERHEIM GM 1000

Digital Signal Processor

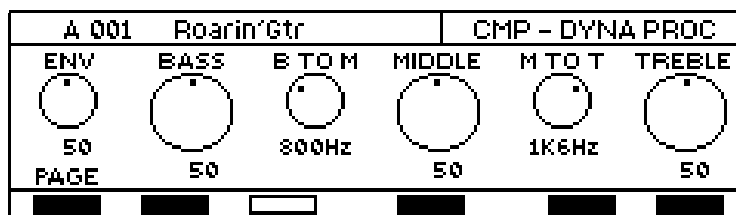

Env Parameter. Range: 0 - 100

Regulates the times of response to the signal dynamics.

Bass Parameter. Range: 0 - 100

Middle Parameter. Range: 0 - 100

Treble Parameter. Range: 0 - 100

B To M Parameter Range: 63, 80, 100, 125, 160, 200, 250, 320, 400, 500, 635, 800, 1k, 1k25, 1k6, 2k, 2k5, 3k2, 4k, 5k, 6k4, 8k, 10k, 12k8, 16k Hz

M To T Parameter Range: 63, 80, 100, 125, 160, 200, 250, 320, 400, 500, 635, 800, 1k, 1k25, 1k6, 2k, 2k5, 3k2, 4k, 5k, 6k4, 8k, 10k, 12k8, 16k Hz

These parameters control the crossover cut-off frequencies. The information given in the description of the DeEsser applies.

6.2 DISTORTION (DST)

DISTORTION

This is absolutely the best known guitar effect. It simulates the distortion of an amplifier which has been saturated so that it emits a hard, piercing sound. It is often used for soloists.



Type parameter. Range: Standard 1, Standard 2, Standard 3, Mellow 1, Mellow 2, Mellow 3, Boosted 1, Boosted 2, Heavy Tube 1, Heavy Tube 2, Heavy Tube 3, Hi-Energy 1, Hi-Energy 2, Hi-Energy 3, Hi-Energy 4.

Sets the type of distortion.

Drive parameter. Range: 0-64

Controls the intensity of the effect.

HDamp parameter. Range: 4K0, 3K2, 2K5, 2K0, 1K6.

Displays the cut-off frequency used by a filter which eliminates all the frequencies above the one set.

OBERHEIM GM 1000

Digital Signal Processor

Level parameter. Range: 0 - 100

Regulates the level of the output signal in the context of the effects chain.

OVERDRIVE

"Valve" type distortion, softer than Distortion.



Type parameter. Range: Standard, UK Tubes, US Tubes, Modern ovd, Hot Tubes, Flattened, Brite Tube, MOS-FET#1, MOS-FET#2, MOS-FET#3.

Sets the type of overdrive.

Drive parameter. Range: 0-64

Controls the intensity of the effect.

HDamp parameter. Range: 4K0, 3K2, 2K5, 2K0, 1K6.

Displays the cut-off frequency used by a filter which eliminates all the frequencies above the one set.

Level parameter. Range: 0 - 100

Regulates the level of the output signal in the context of the effects chain.

CRUNCH

A type of distortion lighter than the previous types. Often used for the rhythm section.



Type parameter. Range: Standard 1, Standard 2, Old Tubes, UK feel, US feel, Fat Tubes, Mid Peaked, Hot Tubes.

Sets the type of crunch.

Drive parameter. Range: 0-64

OBERHEIM GM 1000

Digital Signal Processor

Controls the intensity of the effect.

HiDamp parameter. Range: 4K0, 3K2, 2K5, 2K0, 1K6.

Displays the cut-off frequency used by a filter which eliminates all the frequencies above the one set.

Level parameter. Range: 0 - 100

Regulates the level of the output signal in the context of the effects chain.

6.3 EQUALIZER (EQ)

10 BANDS GRAPHIC

This is a 10 band graphic equalizer. Since the frequencies at which it intervenes are preset, the controls relate to the degree of attenuation and enhancement between -14dB and +14dB.

Level parameter. Range: 0 - 100

Regulates the level of the output signal in the context of the effects chain.

MONO PARAMETRIC

This is a parametric equalizer in which the user can modify the working frequencies, band widths and intervention levels.

A 001	Roarin'Gtr	EQ - MONO PARA
LO CUT	▶ F: 35	
LO SHELVE	▶ F: 50 Hz	▶ B/C: + 0 dB
HI SHELVE	▶ F: 1K5 Hz	▶ B/C: + 0 dB
HI CUT	▶ F: OFF	
PAGE	▶ LEVEL	95

Low Frequency Cut filter. Freq. Range: OFF, 50, 70, 100, 140, 200 Hz.

This filter is used to eliminate the lowest frequencies.

Low Shelve filter. Freq. Range: 50, 70, 100, 140, 200, 280, 400 Hz
Boost/Cut Range: +14dB / -14dB

This filter (of shelving type) enhances or attenuates the frequencies between the value set and 0 Hz. The parameters which can be modified are the working frequency and the trigger level.

High Shelve filter. Freq. Range: 1k5, 2k1 (2k12), 3k0, 4k2 (4k25), 6k0, 8k5, 12k Hz

OBERHEIM GM 1000

Digital Signal Processor

Boost/Cut Range: +14dB / -14dB

This filter (of shelving type) enhances or attenuates the frequencies between the value set and the maximum frequency the machine controls. The parameters which can be modified are the working frequency and the trigger level.

High Frequency Cut filter. Freq. Range: OFF, 3k0, 4k2 (4k25), 6k0, 8k5, 12k, 16k Hz

This filter eliminates the highest frequencies; the cut-off frequency can be adjusted.

Level parameter. Range: 0 - 100

Regulates the level of the output signal in the context of the effects chain.

A 001 Roarin'Gtr	EQ - MONO PARA		
1ST PEAK ▶ F: 100 Hz	▶ Q: 0.5	▶ B/C: - 8 dB	
2ND PEAK ▶ F: 800 Hz	▶ Q: 0.5	▶ B/C: +10 dB	
3RD PEAK ▶ F: 2k0 Hz	▶ Q: 0.5	▶ B/C: + 8 dB	
PAGE			
█	█	█	█







A 001 Roarin'Gtr	EQ - MONO PARA		
4TH PEAK ▶ F: 2k8 Hz	▶ Q: 0.5	▶ B/C: + 8 dB	
5TH PEAK ▶ F: 4k0 Hz	▶ Q: 0.5	▶ B/C: - 5 dB	
6TH PEAK ▶ F: 8k0 Hz	▶ Q: 0.5	▶ B/C: + 0 dB	
PAGE			
█	█	█	█

Peaking 1 - 6 filters. Frequency Range: 100, 140, 200, 280, 400, 560, 800, 1k0, 1k4, 2k0, 2k8, 4k0, 5k6, 8k0 Hz
 Bandwidth (Q) Range: 0.5, 1, 2, 3
 Boost/Cut Range: +14 dB / -14 dB

These are 6 separate filters (of peaking type) for each of which the user can select the band centre frequency, the Q factor (operating range) and the enhancement or attenuation value.

GUITAR

This effect simulates the behaviour of the equalization section of a combo amplifier for guitar. The user is offered the controls generally found on the console of the type of amplifier to be simulated. These are BASS, MIDDLE, TREBLE, NOTCH and PRESENCE.

A 001 Roarin'Gtr			EQ - GUITAR		
BASS	MIDDLE	TREBLE	NOTCH	PRESENCE	LEVEL
					
50	50	50	+8	-8	95
█	█	█	█	█	█

OBERHEIM GM 1000

Digital Signal Processor

Bass parameter. Range: 0 - 100

Regulates the bass tone section.

Middle parameter. Range: 0 - 100

Regulates the middle tone section.

Treble parameter. Range: 0 - 100

Regulates the treble tone section.

Notch parameter. Range: -14dB/+14dB

The Notch parameter regulates a filter which has a differentiated operating mode: its enhancement zone is centred on 1225 Hz, while for attention it focuses on 1950 Hz.

Presence parameter. Range: -14db/+14dB

This filter is also differentiated. For the enhancement zone it uses a Presence filter centred on 2100 Hz, while for attenuation it uses another working on 10 KHz.

Level parameter. Range: 0 - 100

Regulates the level of the output signal in the context of the effects chain.

5 BANDS GRAPHIC

This is a five-band stereo graphic equalizer.

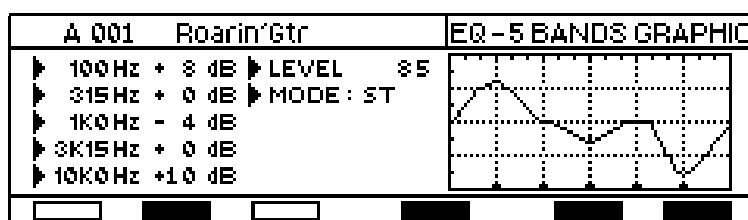

100 Hz, 315 Hz, 1K Hz, 3K15 Hz, 10k parameters. Range: -14 +14 dB.

These select enhancement or attenuation for the specified frequencies.

Mode parameter. Range: Stereo, Dual

This parameter establishes whether the two sections, Left and Right, will be set up in the same way (STEREO) or in two different ways (DUAL).

Level parameter. Range: 0 - 100

OBERHEIM GM 1000

Digital Signal Processor

Regulates the level of the output signal in the context of the effects chain.

STEREO PARAMETRIC

This is a parametric equalizer, meaning an equalizer in which the user is able to modify the operating frequencies, band widths and intervention levels as he pleases. This allows perfect selection of one or more frequencies to be enhanced or attenuated.

A 001 Roarin'Gtr	EQ - STEREO PARA
LOCUT ▶ F: OFF	
LO SHELVE ▶ F: 50 Hz	▶ B/C: + 0 dB
HI SHELVE ▶ F: 3K5 Hz	▶ B/C: + 0 dB
▶ LEVEL ▶ LEVEL ██████████	95 ▶ MODE:ST
PAGE	
██████	██████

Low cut frequency filter. OFF, 35, 50, 70, 100, 140, 200.

This filter is used to eliminate the lowest frequencies.

Low Shelf filter. Freq. Range: 50, 70, 100, 140, 200, 280, 400 Hz
Enhancement/Attenuation Range: +14dB / -14dB

This filter (of shelving type) enhances or attenuates the low frequencies. The parameters which can be modified are the working frequency and the trigger level.

High Shelf filter. Freq. Range: 1k5, 2k1, 3k0, 4k2, 6k0, 8k5, 12k Hz
Enhancement/Attenuation Range: +14dB / -14dB

This filter (of shelving type) enhances or attenuates the high frequencies. The parameters which can be modified are the working frequency and the trigger level.

Level parameter. Range: 0 - 100

Regulates the level of the output signal in the context of the effects chain.

Mode parameter. Range: Stereo, Dual

This parameter establishes whether the two sections, Left and Right, will be set up in the same way (STEREO) or in two different ways (DUAL). In the former case editing of the parameters modifies both sections (LEFT and RIGHT) simultaneously. Conversely DUAL mode allows separate editing for the left and right channels: the letter L (LEFT) or R (RIGHT) will identify the channel currently being modified.

A 001 Roarin'Gtr	EQ - STEREO PARA
L.M. PEAK ▶ F: 800 Hz	▶ Q: 0.5 ▶ B/C: + 8 dB
H.M. PEAK ▶ F: 2K0 Hz	▶ Q: 0.5 ▶ B/C: - 2 dB
PAGE	
██████	██████

OBERHEIM GM 1000

Digital Signal Processor

Low-Mid Peak filter. Frequency Range: 100, 140, 200, 280, 400, 560, 800, 1k1, 1k6 Hz
 Bandwidth (Q) Range: 0.5, 1, 2, 3
 Enhancement/Attenuation Range: +14dB / -14dB

This is a peaking filter which operates on the medium-low frequencies, capable of enhancing or attenuating the frequencies around the frequency set using the parameter F; the filter bandwidth is set by the parameter Q; the enhancement or attenuation is set by the parameter dB.

Filtro "High-Mid Peak". Frequency Range: 500, 700, 1k0, 1k4, 2k0, 2k8, 4k0, 5k6, 8k0 Hz
 Bandwidth (Q) Range: 0.5, 1, 2, 3
 Enhancement/Attenuation Range: +14dB / -14dB

Filter identical to the previous one, with different band centre values shifted further towards the medium-high frequencies.

6.4 AMP SIMULATOR (AMP)

One important component of guitar and electric bass sounds is the modification of the frequency response created by the amplifier's cabinet and speakers.

When a multieffect device is connected directly to the mixer of a P.A. system (i.e. without using the amplifier), this component is lacking. The most noticeable result is the lack of "body" in the distortions, which become "cold" and "plastic".

Although the GM 1000 distortions have also been developed for use "directly", algorithms have been added to simulate the presence of an amplifier, where the user is enabled to decide both its construction characteristics and the incidence of the device on the overall sound quality.

GUITAR AMP

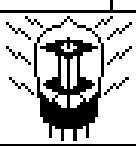
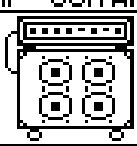
A 001	Roarin'Gtr		AMP - GUITAR
▶ AMPTYPE	4		
▶ CHARACTER	62		
▶ BOXTYPE	3		
▶ INFLUENCE	17		
▶ LEVEL	100		
<input type="checkbox"/> <input type="checkbox"/> <input type="checkbox"/> <input type="checkbox"/>			

Amp Type parameter. Range: DI, V, S, HV

This parameter is used to set the type of amplifier to be simulated. The values this field is able to assume are:

- 1 (DI BOX): DI BOX (linear response) simulation
- 2 (VALVE): Simulation of a valve amplifier
- 3 (SOLID STATE): Simulation of a transistor amplifier
- 4 (HOT VALVE): Simulation of a saturated valve amplifier.

Character parameter. Range: 0 - 100

Parameter which sets the incidence of the AMP TYPE parameter in the context of the amp simulator.

OBERHEIM GM 1000

Digital Signal Processor

Box Type parameter. Range: 112, 212, 412.

The Box type parameter allows the user to set the type of box with which the amplifier to be simulated is equipped.

- 1 (112): Simulation of a combo amplifier equipped with one 12 inch speaker
- 2 (212): Simulation of a combo amplifier equipped with two 12 inch speakers
- 3 (412): Simulation of a combo amplifier equipped with four 12 inch speakers

Influence parameter. Range: 0 - 100

Parameter which sets the incidence of the BOX TYPE parameter in the context of the amp simulator.

Level parameter. Range: 0 - 100

Regulates the level of the output signal in the context of the effects chain.

BASS AMP

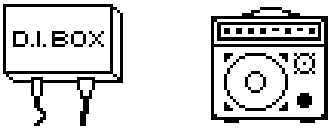
A 001 Roarin'Gtr	AMP - BASS
▶ AMPTYPE 1	
▶ CHARACTER 70	
▶ BOXTYPE 2	
▶ INFLUENCE 100	
▶ LEVEL 95	
<div style="display: flex; justify-content: space-around;"> <div style="width: 20%; height: 10px; background-color: black;"></div> <div style="width: 20%; height: 10px; background-color: black;"></div> <div style="width: 20%; height: 10px; background-color: black;"></div> <div style="width: 20%; height: 10px; background-color: black;"></div> <div style="width: 20%; height: 10px; background-color: black;"></div> <div style="width: 20%; height: 10px; background-color: black;"></div> </div>	

Amp Type parameter. Range: DI, V, S, HV

This parameter is used to set the type of bass amplifier to be simulated. The values this field is able to assume are:

- 1 (DI BOX): DI BOX (linear response) simulation
- 2 (VALVE): Simulation of a valve amplifier
- 3 (SOLID STATE): Simulation of a transistor amplifier
- 4 (HOT SOLID STATE): Simulation of a saturated transistor amplifier.

Character parameter. Range: 0 - 100

Parameter which sets the incidence of the AMP TYPE parameter in the context of the amp simulator.

Box Type parameter. Range: 112, 12T, 115

The Box type parameter allows the user to set the type of box with which the bass amplifier to be simulated is equipped.

- 1 (112): Simulation of a combo amplifier equipped with one 12 inch speaker
- 2 (12T): Simulation of a combo amplifier equipped with one 12 inch speaker with bass reflex system and tweeter

OBERHEIM GM 1000

Digital Signal Processor

3 (115): Simulation of a combo amplifier equipped with one 15 inch speaker with bass reflex system

Influence parameter. Range: 0 - 100

Parameter which sets the incidence of the BOX TYPE parameter in the context of the amp simulator.

Level parameter. Range: 0 - 100

Regulates the level of the output signal in the context of the effects chain.

6.5 MODULATION (MOD)

CHORUS

The Chorus effect is obtained by subdividing the signal into two lines: one remains unchanged while the tuning of the other is modified slightly in a cyclical way (modulation). The two lines are then mixed and the resulting sound has more "body", is richer and seems "roomier" than the original.

A 001 Roarin'Gtr	MOD - CHORUS
▶ TYPE : DOUBLE	
▶ RATE 6	
▶ DEPTH 0	
▶ PRE-DELAY (mS) 0	
▶ EFFECT 100	
	▶ DIRECT 100
	▶ MASTER 100
<input type="checkbox"/> <input type="checkbox"/> <input type="checkbox"/> <input type="checkbox"/> <input type="checkbox"/> <input type="checkbox"/>	

Type parameter. Range: Stereo, Mono, Double

The parameter which selects the type of Chorus.

Rate parameter. Range: 0 - 100

Sets the modulation frequency.

Depth parameter. Range: 0 - 100

This parameter regulates the depth of the modulation.

Pre Delay parameter. Range: 0 - 100 msec

This parameter sets the modulation delay time.

Effect Level parameter. Range: 0 - 100

Regulates the level of the effect, i.e. of the modulated line.

Direct Level parameter. Range: 0 - 100

OBERHEIM GM 1000

Digital Signal Processor



This parameter regulates the level of the direct signal.

Master parameter. Range: 0 - 100

Regulates the level of the output signal in the context of the effects chain, in this case the sum of the processed sound and the direct sound, mixed by means of the EFFECT LEVEL and DIRECT LEVEL parameters.

FLANGER

The Flanger effect is basically the same as the Chorus, but a feedback of the signal to the input is added. The effect obtained is often compared to the sound emitted by a jet during take-off.

A 001 Roarin'Gtr	MOD - FLANGER
▶ TYPE : DOUBLE	
▶ RATE 44	▶ DEPTH 25
▶ RESONANCE 40	▶ MANUAL 3
▶ DIRECT 100	▶ EFFECT 70
▶ MASTER 	▶ 95
	

Type parameter. Range: STEREO, MONO, DOUBLE

The parameter which selects the type of Flanger.

Rate parameter. Range: 0 - 100

Sets the modulation frequency.

Depth parameter. Range: 0 - 100

This parameter regulates the depth of the modulation.

Resonance parameter. Range: -100 - +100

This is the parameter which actually differentiates the Chorus effect from the Flanger; it regulates the amount of feedback returned to the effect input.

Manual parameter. Range: 0 - 100

This parameter sets the modulation delay time.

Direct Level parameter. Range: 0. 100

This parameter regulate the level of the direct signal.

Effect Level parameter. Range: 0 - 100

Regulates the level of the effect, i.e. of the modulated line.

OBERHEIM GM 1000

Digital Signal Processor

Level parameter. Range: 0 - 100

Regulates the level of the output signal in the context of the effects chain, in this case the sum of the processed sound and the direct sound, mixed by means of the EFFECT LEVEL and DIRECT LEVEL parameters.

PHASER

In principle this effect works like the Chorus and Flanger, but instead of adding a modulated line to the direct sound, it offers the addition of a line with slightly staggered timing. In other words, it reconstructs the effect created by two recorders playing the same tape simultaneously but one a very few milliseconds after the other. The resulting sound, created as frequencies are added and removed, is similar to that obtained with the Flanger, although in this case it is a little more tenuous and "thinner".

A 001 Roarin'Gtr	MOD - PHASER
▶ TYPE : STEREO	
▶ RATE 50	
▶ DEPTH 25	
▶ MANUAL 7	
▶ EMPHASIS 6	
	▶ PHASE 0
	▶ LEVEL 95
<input type="checkbox"/> <input checked="" type="checkbox"/> <input type="checkbox"/>	<input checked="" type="checkbox"/> <input checked="" type="checkbox"/> <input checked="" type="checkbox"/>

Type parameter. Range: Stereo, Mono.

The parameter which selects the type of Phaser.

Rate parameter. Range: 0 - 100

Sets the modulation frequency.

Depth parameter. Range: 0 - 100

This parameter regulates the depth of the modulation.

Manual parameter. Range: 0 - 100

This parameter sets the modulation delay.

Phase parameter. Range: 0- 100

Allows the modification of the relative modulation phase.

Emphasis parameter. Range 0 - 100

The parameter governs the amount of feedback to be returned to the effect input.

Level parameter. Range: 0 - 100

Regulates the level of the output signal in the context of the effects chain.

OBERHEIM GM 1000

Digital Signal Processor

STEP PHASER

The Step Phaser carries out a modulation on the basis of a Sample and Hold.

A 001 Roarin'Gtr	MOD - STEP PHASER
▶ RATE 90	
▶ STEP 58	
▶ DEPTH 55	
▶ MANUAL 20	
▶ LEVEL 	
	▶ EMPHASIS 2
	

Rate parameter. Range: 0 - 100

Sets the modulation frequency.

Step parameter. Range: 0 - 100

Establishes the relationship between the modulator and the sampling. In other words, it sets the waveform which will modulate the input signal.

Depth parameter. Range: 0 - 100

This parameter regulates the depth of the modulation.

Manual parameter. Range: 0 - 100

This parameter sets the modulation delay.

Emphasis parameter: Range 0 - 100

The parameter governs the amount of feedback to be returned to the effect input.

Level parameter. Range: 0 - 100

Regulates the level of the output signal in the context of the effects chain.

TREMOLO

This effect produces a periodic variation of volume, at regular intervals, with adjustment of the modulation speed and intensity.

A 001 Roarin'Gtr	MOD - TREMOLO
▶ THRESHOLD 82	▶ RELEASE TIME 88
▶ ATTACK TIME 6	▶ PAN-POT 20
▶ WAVEFORM 6	▶ DEPTH 50
▶ SPEED 85	▶ LEVEL
	

Threshold parameter. Range: 0 - 100

Sets the level of the input signal above which the effect is activated.

OBERHEIM GM 1000

Digital Signal Processor

Attack Time parameter. Range: 0 - 100

Sets the amount of time which will pass after the input signal has exceeded the threshold before the tremolo will start.

Release Time parameter. Range: 0 - 100

In contrast with the Attack parameter, this parameter sets the time for which the effect will last.

Waveform parameter. Range 0 - 24

This parameter influences the waveform of the modulating signal by modifying the gradient of the up and down fronts of a trapezoidal waveform.

Panpot parameter. Range: 0 - 100

This parameter adjusts the relative time stagger between the Left and Right channels.

Speed parameter. Range: 0 - 100

Sets the modulation speed.

Depth parameter. Range: 0 - 100

Regulates the depth of the modulation.

Level parameter. Range: 0 - 100

Regulates the level of the output signal in the context of the effects chain.

VIBRATO

The effect works in a similar way to the Tremolo, but instead of affecting the volume it acts on the tuning of the sound.

A 001 Roarin'Gtr	MOD - VIBRATO
▶ THRESHOLD 10	
▶ ATTACK TIME 45	
▶ RELEASE TIME 26	
▶ SPEED 80	
▶ LEVEL 	
 	

Threshold parameter. Range: 0 - 100

Sets the level of the input signal above which the effect is activated.

Attack Time parameter. Range: 0 - 100

OBERHEIM GM 1000

Digital Signal Processor

Sets the amount of time which will pass after the input signal has exceeded the threshold before the tremolo starts.

Release Time parameter. Range: 0 - 100

In contrast with the Attack parameter, this parameter sets the time for which the effect will last.

Speed parameter. Range: 0 - 100

Sets the modulation speed.

Depth parameter. Range: 0 - 100

Sets the depth of the modulation.

Level parameter. Range: 0 - 100

Regulates the level of the output signal in the context of the effects chain.

6.6 SPECIAL EFFECTS 1 (SP1)

WAH-WAH

This simulates the well-known effect which sounds exactly like its name. It is obtained by means of a filter which is opened and closed automatically by the level of the signal itself, or by means of a remote pedal.

A 001 Roarin'Gtr	SP1 - WAH WAH
▶ TRIGGER : AUTO POST	
▶ MODE : BAND PASS	
▶ POLARITY : WHA	▶ PEAK 8
▶ MANUAL 85	▶ LEVEL 100
▶ SENSITIVITY 100	

Trigger parameter. Range: AUTO PRE, AUTO POST, PEDAL FC1, PEDAL FC2.

Sets the type of control of the effect. The two Auto options are provided to allow control by the level of signal present before compression (PRE) or downstream of all the preceding effects (POST). For pedal control, there is the option of control using Foot Controller 1 (FC1) or Foot Controller 2 (FC2) of the optional foot-controller unit FC-3000.

Mode parameter. Range: LOW PASS, BAND PASS

The Wah filter can be preset as a Low Pass or Band Pass filter.

Polarity parameter. Range: WAH, HAW

The filter can be made to move towards the higher frequencies with rising control level (Wah) or to close as the level grows (Haw).

OBERHEIM GM 1000

Digital Signal Processor

These two parameters act on the levels of the two lines, thus modifying the influence of the two resonance patterns.

Level parameter. Range: 0 - 100

Regulates the level of the output signal in the context of the effects chain.

DBL CHORUS

This is an additional Chorus module which differs from the one in the Modulation (MOD) block in that it has two different modulants, the sum of which gives less regular repetition patterns. The two modulants may have different frequencies and depths.

A 001 Roarin'Gtr	SP1 - DBL CHORUS
▶ RATE 1 80	▶ RATE 2 69
▶ DEPTH 1 23	▶ DEPTH 2 12
▶ PRE-DELAY (ms) 15	
▶ DIRECT 100	▶ EFFECT 50
▶ MASTER	100

Rate 1 and Rate 2 parameters. Range 0 - 100

Sets the frequency of each of the two modulants.

Depth 1 and Depth 2 parameter. Range: 0 - 100

This parameter regulates the modulation depth for each modulant.

Pre Delay parameter. Range: 0 - 100

This parameter sets the modulation delay time.

Direct Level parameter. Range: 0 - 100

This parameter regulates the level of the direct signal.

Effect Level parameter. Range: 0 - 100

Regulates the level of the effect, i.e. of the modulated lines.

Level parameter. Range: 0 - 100

Regulates the level of the output signal in the context of the effects chain, in this case the sum of the processed sound and the direct sound, mixed by means of the EFFECT LEVEL and DIRECT LEVEL parameters.

RING MODULATOR

This effect modulates the amplitude of a sinusoidal carrier at audio frequency (ring modulation).

OBERHEIM GM 1000

Digital Signal Processor

A 001 Roarin'Gtr	SP1 - RING MOD
▶ FREQUENCY 26	▶ SENSITIVITY 52
▶ MODULATION RATE 51	▶ MODULATION DEPTH 7
▶ DIRECT ██████████	44
▶ EFFECT ████████	15
▶ MASTER ████████████████████	78
<input type="checkbox"/> <input type="checkbox"/> <input type="checkbox"/> <input type="checkbox"/> <input type="checkbox"/> <input type="checkbox"/>	

Frequency parameter. Range: 0 - 100

Regulates the frequency of the carrier, in the range 500 Hz - 5 KHz.

Sensitivity parameter. Range: 0 - 100

This parameter regulates the sensitivity of the modulation depth parameter to the signal dynamics.

Modulation rate parameter. Range: 0 - 100

This parameter regulates the speed of the modulation oscillator.

Modulation depth parameter. Range: 0 - 100

The parameter regulates the modulation depth.

Direct parameter. Range: 0 - 100

This parameter regulates the level of the direct signal.

Effect parameter. Range: 0 - 100

Regulates the level of the effect, i.e. of the modulated lines.

Level parameter. Range: 0 - 100

Regulates the level of the output signal in the context of the effects chain, in this case the sum of the processed sound and the direct sound, mixed by means of the EFFECT LEVEL and DIRECT LEVEL parameters.

AUTO PAN

This is an effect which makes an automatic panpotting assignment (i.e. a stereophonic

A 001 Roarin'Gtr	SP1 - AUTO PAN
▶ THRESHOLD 50	▶ RELEASE TIME 48
▶ ATTACK TIME 10	▶ DEPTH 25
▶ RATE 88	
▶ LEVEL ████████████████████	80
<input type="checkbox"/> <input type="checkbox"/> <input type="checkbox"/> <input type="checkbox"/> <input type="checkbox"/> <input type="checkbox"/>	

front assignment).

Threshold parameter. Range: 0 - 100

OBERHEIM GM 1000

Digital Signal Processor

Sets the level of the input signal above which the effect is activated.

Attack Time parameter. Range: 0 - 100

Sets the amount of time which will pass after the input signal has exceeded the threshold before the tremolo starts.

Release Time parameter. Range: 0 - 100

In contrast with the Attack parameter, this parameter sets the time for which the effect will last.

Rate parameter. Range: 0 - 100

Sets the modulation speed.

Depth parameter. Range: 0 - 100

Sets the depth of the modulation.

Level parameter. Range: 0 - 100

Regulates the level of the output signal in the context of the effects chain.

FADE IN

An effect which consists of a gradual rise in the volume, attenuating or eliminating perception of the start of the input signal sound. It is often used by guitarists to create a sound similar to that produced by a violin.

A 001 Roarin'Gtr	SP1 - FADE IN
▶ MODE : DE-ENV	
▶ THRESHOLD	94
▶ TIME	90
▶ HOLD	20
▶ LEVEL	90

Mode parameter. Range: SLIDER/DE-ENV

This sets the operating mode of the effect. With Slider, once the trigger threshold is exceeded the volume will rise; this will stop as soon as the signal drops back below the threshold. With De-env, when the signal moves from below to above the threshold, the volume will be raised/lowered.

Threshold parameter. Range: 0 - 100

Sets the signal intervention threshold above which the effect is activated.

Time parameter. Range: 0 - 100

OBERHEIM GM 1000

Digital Signal Processor

Regulates the effect opening time, in a range which is diversified depending on the operating mode (SLIDER/DE-ENV).

Hold parameter. Range: 0 - 100 (only present in DE-ENV mode).

In DE-ENV mode, it sets the time for which any transitions around the threshold will not be considered.

Level parameter. Range: 0 - 100

Regulates the level of the output signal in the context of the effects chain.

6.7 SPECIAL EFFECTS 2 (SP2)

SHIFTING DELAY

The Pitch Shifter adds a line which can be freely tuned by the user to the original signal. This effect is a two line version of the Pitch Shifter, available in two versions, both with Pre Delay and Feedback; a first version is stereophonic while the second, mono, version allows greater Pre Delay.

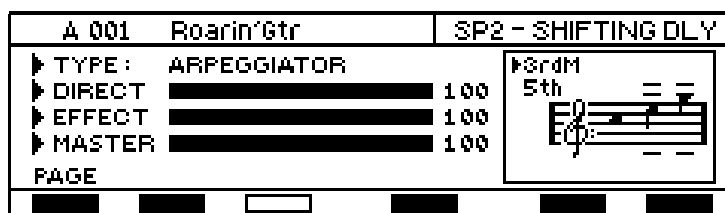

Type parameter. Range: STEREO, ARPEGGIATOR

Sets the operating mode of the Shifting Delay.

Direct parameter. Range: 0 - 100

This parameter regulates the level of the direct signal.

Effect parameter. Range: 0 - 100

This parameter regulates the level of the effect acting together with the Pan parameter of the single lines.

Master parameter. Range: 0 - 100

Regulates the level of the output signal in the context of the effects chain.

OBERHEIM GM 1000

Digital Signal Processor

A 001 Roarin'Gtr	SP2 - SHIFTING DLY
▶ MODE 4 ▶ LINE A ▶ SHIFT + 4 ▶ FINE + 0 ▶ PRE-DELAY (mS) 88 ▶ FEEDBACK + 88 PAGE ▶ PAN L 50 R 50	

Mode parameter. Range: 1 - 4

This parameter sets the Shifting length.

Line parameter. Range: L, R in case of Stereo; A, B in case of Arpeggiator

This parameter determines which of the 2 lines is to be modified. For uniformity with the selected type, the two lines are called L and R in the case of Stereo and A and B in the case of the Arpeggiator. Naturally, only the line highlighted will be shown and modified.

Shift parameter. Range: -24 - +24

Fine parameter. Range: -50 - +50

These parameters clearly set the quantity of frequency shift required, subdivided into a roughly accurate part set in semitones (Shift) and a fine part set in hundredths of a tone (Fine).

Pre-Delay parameter: Range: 0 - 100 in case of Stereo; 0 - 300 in case of Arpeggiator.

This parameter sets the shifting delay time.

Feedback parameter. Range: -100 - +100

Regulates the entity of the resonances by adjusting the feedback values.

Pan parameter. Range: L = 0 - 100, R = 100- 0

The Panning of the outputs of the two lines is also affected by the level of the effect and of the Master parameter, by means of the two EFFECT and MASTER settings described above.

3 VOICE PEDAL PITCH SHIFTER

A further version of the Pitch Shifter. This algorithm allows production of three separate shifting lines separately.

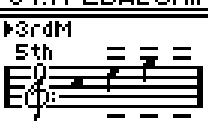
A 001 Roarin'Gtr	SP2-3V/PEDAL SHIFT
▶ MODE 5 ▶ LINE 1 ▶ SHIFT + 4 ▶ FINE 0 ▶ LEVEL ██████████ 100 ▶ DIRECT ██████████ 100 ▶ MASTER ██████████ 100	

Mode parameter. Range: 1 - 5

OBERHEIM GM 1000

Digital Signal Processor

This parameter sets the length of the Shifting.

Line parameter. Range: 1 - 3

This parameter establishes which of the 3 lines is to be modified. Naturally, only the line highlighted will be shown and modified.

Shift parameter. Range: -24 - +24

Fine parameter. Range: -50 - +50

These parameters clearly set the quantity of frequency shift required, subdivided into a roughly accurate part set in semitones (Shift) and a fine part set in hundredths of a tone (Fine).

Level parameter. Range: 0 - 100

Regulates the level of the individual shifting lines.

Direct parameter. Range: 0 - 100

Regulates the level of the direct signal.

Master parameter. Range: 0 - 100

Regulates the level of the output signal in the context of the effects chain.

CUSTOM SHIFT

A further version of the Pitch Shift which can be completely programmed by the user. It allows any note chosen by the user to be added to a note played.

A 001 Roarin'Gtr	SP2 - CUSTOM P.SHIFT
▶ KEY NOTE: C	▶ MODE 4
▶ DIRECT	100
▶ EFFECT	100
▶ MASTER	100
PAGE	
█ █ █ █ █ █	

Key Note parameter. Range: C, C#. D, D#, E, F, F#, G, G#, A, A#, B.

Selects the note to be edited in editing page 2 for creation of the shifting.

Mode parameter. Range: 1 - 4

This parameter sets the length of the Shifting.

Direct parameter. Range: 0 - 100

Regulates the level of the direct signal.

OBERHEIM GM 1000

Digital Signal Processor

Effect parameter. Range: 0 - 100

Regulates the level of the shifting line.

Master parameter. Range: 0 - 100

Regulates the level of the output signal in the context of the effects chain.

A 001 Roarin'Gtr	SP2-CUSTOMP.SHIFT
SHIFT ▶C :+ 4[E]	▶E :+ 3[G]
▶C# :+ 0[C#]	▶F :+ 0[F]
▶D :+ 0[D]	▶F# :+ 0[F#]
▶D# :+ 0[D#]	▶G :+ 5[G]
PAGE	
<div style="display: flex; justify-content: space-around; width: 100%;"> <div style="width: 15%; height: 10px; background-color: black;"></div> <div style="width: 15%; height: 10px; background-color: black;"></div> <div style="width: 15%; height: 10px; border: 1px solid black;"></div> <div style="width: 15%; height: 10px; background-color: black;"></div> <div style="width: 15%; height: 10px; background-color: black;"></div> <div style="width: 15%; height: 10px; background-color: black;"></div> </div>	

The second editing page is entirely dedicated to the table where the note played is combined with the note created by the Shifted in order to obtain the desired effect.

4 VOICE CHORUS

This is a further version of the Chorus featuring no less than 4 stereophonic lines (voices) to give the effect the maximum "roominess" and depth.

Voice parameter. Range: 1 - 4

Selects which of the 4 lines is to be modified.

Rate parameter. Range: 0 - 100.

Regulates the modulation speed of the selected voice.

Pre-Delay parameter. Range: 0 - 100

This parameter sets the effect delay time of the selected voice.

Depth parameter. Range: 0 - 100

This parameter regulates the modulation depth for each voice selected.

Level parameter. Range: 0 - 100

Regulates the level of the selected voice.

Direct parameter. Range: 0 - 100

Regulates the level of the direct signal.

Level parameter. Range: 0 - 100

Regulates the level of the output signal in the context of the effects chain, in this case the sum of the processed sound and the direct sound, mixed by means of the LEVEL parameter of the 1st editing page of the effect and the DIRECT LEVEL parameter.

OBERHEIM GM 1000

Digital Signal Processor

determined by the FALL TIME (Hi Section Fall Time for the High section and Lo Section Fall Time for the Low section).

DENOISER

As its name suggests, this effect is used to eliminate any hums or unwanted noises.



Mode parameter. Range: 2 bands + hum, 2 bands

Establishes the operating mode of the Denoiser.

Ratio parameter. Range: 1:1, 1:2, 1:3, 1:4, 1:5.

Sets the compression ratio.

Threshold parameter. Range: 0 - 100

Sets the input signal threshold above which the effect is activated.

Level parameter. Range: 0 - 100

Regulates the level of the output signal in the context of the effects chain.

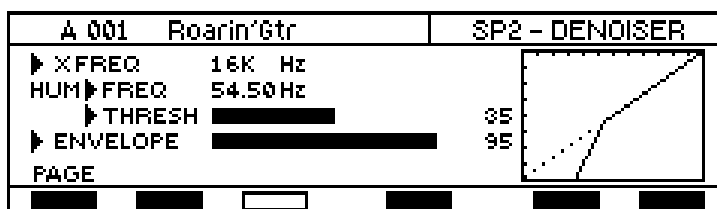

Xfreq parameter. Range: 63, 80, 100, 125, 160, 200, 250, 320, 400, 500, 635, 800, 1 k, 1.2k, 1.6k, 2k, 2.5k, 3.2k, 4k, 5k, 6.4k, 8k, 10k, 13k, 16k.

Sets the trigger frequency/ies on which the compression effect may operate.

Hum parameter. Range: 35 - 75 Hz (only present with 2 bands + hum)

Threshold parameter. Range: 0 - 64 (only present with 2 bands + hum)

These parameters select the cut-off frequency and intervention threshold on the low frequency hum.

Envelope parameter. Range: 0 - 100

Filter envelope speed.

OBERHEIM GM 1000

Digital Signal Processor

6.8 DELAY (DLY)

This effect is one of the best known and is used in combination with the guitar sound. It consists of fragmented, timed repetition of the original signal. It is better known as the "echo" effect.

STANDARD DELAY

This is the simplest of delays, produced on a single mono line which can reach a delay of 2 seconds.

A 001 Roarin'Gtr	DLY - STND DELAY
▶ TIME <input type="checkbox"/>	268mS
▶ F.BACK <input type="checkbox"/>	5 ▶ HIDAMP None
▶ LEVEL <input type="checkbox"/>	12
▶ DIRECT <input type="checkbox"/>	100
▶ MASTER <input type="checkbox"/>	100
<input type="checkbox"/>	<input type="checkbox"/>

Delay Time parameter. Range: 0 - 2000 msec.

Sets the delay time of the echo effect.

Feedback parameter. Range: 0 - 100

Parameter on the 0 - 100 scale of absolute values which regulates the quantity of signal returned to the input of the delay line, and thus the time after which the repetition ceases.

Hi Damp parameter. Range: None, 20K, 19K, 18K, 17K, 16K, 14K5, 12K5, 11K5, 10K, 9K, 8K, 6K35, 5K05, 4K, 2K, 1K.

Displays the cut-off frequency of a filter which eliminates all the frequencies higher than the one set.

Level parameter. Range: 0 - 100

Determines the level of the repetitions provided at the delay line output on an absolute value scale of 0 - 100.

Direct parameter. Range: 0 - 100

Regulates the level of the direct signal on an absolute value scale of 0 - 100.

Master parameter. Range: 0 - 100

Regulates the level of the output signal, on a range of values of 0 - 100, in the context of the effects chain, in this case the sum of the processed sound and the direct sound, mixed by means of the EFFECT LEVEL and DIRECT LEVEL parameters.

OBERHEIM GM 1000

Digital Signal Processor

Control of the HOLD pedal.

The Hold pedal is active on all the Delay effects. Its function is to repeat a memorized phrase indefinitely, with the following mechanism. The first time the pedal is pressed the pattern starting point is established, while the second pressure determines where it will finish; at the same time, the feedback level is brought to the highest setting. This will provide cyclic playback of the phrase played in the interval between the first and second times the pedal was pressed. When the pedal is pressed again, everything is returned to its previous status.

Control of the TAP pedal.

When the Standard Delay effect is present, the TAP pedal is also active. It is used to enter the Time (i.e. delay time) of this delay, not by editing but in real time, in relation to the speed of the song the musician is performing. In practice, the length of the delay will be set by measuring the time which passes between two consecutive pressures on the pedal.

TAP DELAY

This delay offers not just one line or repetition (tap) as in the standard delay, but no less than 8 of them, each one separate with its own delay time, a level and an attribution on the stereo front.

A 001	Roarin'Gtr	DLY - TAP DELAY			
▶ TAP 1	▶ TIME 100ms	▶ PAN L 50	R 50	▶ LEVEL 30	
▶ TAP 2	▶ TIME 200ms	▶ PAN L 50	R 50	▶ LEVEL 30	
F.BACK	▶ TIME 400ms	▶ HIDAMP 12K5		▶ LEVEL 30	
▶ DIRECT	████████████████████				100
▶ MASTER	████████████████████				100
◻	██	◻	██	██	██

Tap parameter. Range: 1 - 8

Allows the user to select one of the 8 tap lines to be modified.

Time parameter. Range: 0 - 2000 msec.

Allows the user to modify the delay time of the selected tap between 0 and 2000 milliseconds.

Pan parameter. Range: L = 0 - 100 - L = 100 - 0

Determines the distribution of the selected tap within the stereo front. The values vary between L 0 - R 100 and L 100 - R 0.

Level parameter. Range: 0 - 100

Sets the output level of the selected tap within the range of values from 1 to 100.

Feedback Time parameter. Range: 0 - 2000 msec.

Regulates the time which the signal takes to return to the input between 0 and 200 msec.

OBERHEIM GM 1000

Digital Signal Processor

Feedback Hi Damp parameter. Range: None, 20K, 19K, 18K, 17K, 16K, 14K5, 12K5, 11K5, 10K, 9K, 8K, 6K35, 5K05, 4K, 2K, 1K.

Displays the cut-off frequency used by a filter which eliminates all the frequencies higher than the one set.

Feedback Level parameter: Range 0 - 100

Regulates, with a range of values of 0 - 100, the quantity of signal returned to the delay line input and thus the time after which the repetitions cease.

Direct parameter. Range: 0 - 100

Regulates the level of the direct signal on a scale of absolute values from 0 to 100.

Master parameter. Range: 0 - 100

Regulates the level of the output signal in the context of the effects chain, within a range of values from 0 to 100.

Control of the HOLD pedal.

The mechanism has already been explained with regard to the Standard Delay.

Control of the TAP pedal.

The TAP pedal is used to enter the Feedback Time, or repetition time, not by manual editing but in real time, in relation to the speed of the song the musician is performing. Its operating principle has already been explained with regard to the Standard Delay.

STEREO DELAY

This is a stereophonic delay, meaning that it has two separate delay lines for the Left and Right channels. This allows a stereophonic panorama to be maintained even for the delayed signal. Each line has 4 separate taps which can be programmed separately. The parameters relating to the two lines, Left and Right, are absolutely identical, and so they will be described together. The edit page, selected using the STEREO DLY icon, will appear as follows:

A 001 Roarin'Gtr		DLY - STEREO DELAY	
▶ TAPL	▶ TIME 100mS	▶ PANL 50 R 50	▶ LEVEL 30
▶ TAPR	▶ TIME 90mS	▶ PANL 50 R 50	▶ LEVEL 30
▶ F.BACK	██████████	25	▶ X.F.BACK █ 5
▶ HDAMP	12K5		
▶ DIRECT	██████████	100	▶ MASTER ██████████ 95
□	████	□	████

Tap parameter. Range: L1 - L4, R1 - R4

Allows the user to select the tap to be modified.

Time parameter. Range: 0 - 1000 msec.

OBERHEIM GM 1000

Digital Signal Processor

Allows the user to modify the delay time for each of the 4 taps.

Pan parameter. Range: L = 0 - 100 - R = 100 - 0

Determines the distribution of the selected tap within the stereo front.

Level parameter. Range: 0 - 100

Allows the user to set the output level of the selected tap.

Feedback parameter. Range: 0 - 100

Regulates the quantity of signal returned to the delay line input and thus the time before the repetitions cease.

X-Feedback parameter. Range: 0 - 100

This is the cross-feedback between the two channels, left and right. This parameter is very useful for the creation of a number of unusual effects.

Hi Damp parameter. Range: None, 20K, 19K, 18K, 17K, 16K, 14K5, 12K5, 11K5, 10K, 9K, 8K, 6K35, 5K05, 4K, 2K, 1K

Displays the cut-off frequency of a filter which eliminates all the frequencies higher than the one set.

Direct parameter. Range: 0 - 100

Regulates the level of the unprocessed signal.

Master parameter. Range: 0 - 100

Regulates the level of the output signal in the context of the effects chain.

Control of the HOLD pedal.

The mechanism has already been explained with regard to the Standard Delay.

MULTI DELAY

In this effect, the delay line has been subdivided into 4 parts, thus creating 4 absolutely independent delays which operate in parallel, each with its own parameters.

A 001	Roarin'Gtr	DLY - MULTI DELAY	
▶ DLY 1	▶ TIME 800ms	▶ FEACK	25
	▶ PAN L 50 R 50	▶ LEVEL	80
		▶ HIDAMP	8K
▶ DIRECT	██		100
▶ MASTER	██		95
▢	▢	▢	▢

DLY parameter. Range: 1- 4

OBERHEIM GM 1000

Digital Signal Processor

Identifies which of the 4 delay lines is to be modified.

Time parameter. Range: 0 - 800(600 - 400 - 200)msec

Regulates the delay time of the delay line being modified. The maximum value depends on the delay selected: 800 msec for the first, 600 for the second, 400 for the third and 200 for the fourth.

F.Back parameter. Range: 0 - 100

Regulates the quantity of signal returned to the input of the delay line selected and thus the time before the repetitions cease.

Pan parameter. Range: L = 0 - 100 - R = 100 - 0

Determines the distribution of the selected line within the stereo front.

Level parameter: Range 0 - 100

Sets the output level of the selected line.

Hi Damp parameter. Range: None, 20K, 19K, 18K, 17K, 16K, 14K5, 12K5, 11K5, 10K, 9K, 8K, 6K35, 5K05, 4K, 2K, 1K.

Displays the cut-off frequency of a filter which eliminates from the taps all the frequencies higher than the one set.

Direct parameter. Range: 0 - 100

Regulates the level of the unprocessed signal.

Master parameter. Range: 0 - 100

Regulates the level of the output signal in the context of the effects chain.

Control of the HOLD pedal.

The mechanism has already been explained, but in this case only one of the 4 delay lines, the longest (i.e. number 1) is switched to Hold mode.

METRONOMIC DELAY 1

The main feature of this delay module is that the delay times can be entered in musical notation rather than in milliseconds, with a value expressed in B.P.M. (beats per minute) as reference.

Structurally, the delay line has been subdivided into 3 parts.

OBERHEIM GM 1000

Digital Signal Processor

A 001 Roarin'Gtr		DLY - METRONOME 1		
▶ BPM : 120				
PATTERN NOTES : VALUE		▶ 1/4	▶ 1/8	▶ 1/16
: LEVEL		▶ 100	▶ 100	▶ 100
▶ FBACK	█	25	▶ HIDAMP	12K5
▶ DIRECT	█	100	▶ MASTER	█ 100
█	█	█	█	█

BPM parameter. Range: 30 - 250

BPM indicates the number of beats per minute: in our case, they are assumed always to be crotchets. The parameter is used to set the delay time on the basis of the metronome speed of the song.

Pattern Notes : Value parameter. Range: 1/4•, 1/4, 1/8•, 1/4T, 1/8, 1/16•, 1/8T, 1/16, 1/32•, 1/16T, 1/32, 1/64•, 1/32T, 1/64, 1/128•, 1/64T, 1/128, 1/128T, OFF (where • represents a dotted triplet).

Selects the musical notation to be used for creation of the delay effect. The user may select three of these parameters, i.e. one for each delay line available.

Pattern notes: Level parameters. Range. 0 - 100

Sets the output level of one of the three delay lines.

Feedback parameter. Range: 0 - 100

Regulates the quantity of signal returned to the input of the delay line selected thus the time before the repetitions cease.

Hi Damp parameter. Range: None, 20K, 19K, 18K, 17K, 16K, 14K5, 12K5, 11K5, 10K, 9K, 8K, 6K35, 5K05, 4K, 2K, 1K.

Displays the cut-off frequency of a filter which eliminates from the taps all the frequencies higher than the one set.

Direct Level parameter. Range: 0 - 100

Regulates the level of the unprocessed signal.

Master parameter. Range: 0 - 100

Regulates the level of the output signal in the context of the effects chain.

Control of the HOLD pedal.

The procedures are as described for the Standard Delay.

Control of the TAP pedal.

The TAP pedal is used to enter the Feedback Time parameter, meaning the tap time, not by manual editing but in real time, in relation to the speed of the song the musician is performing. Its operating principle has already been explained for the Standard Delay.

OBERHEIM GM 1000

Digital Signal Processor

METRONOMIC DELAY 2

Here again, the main prerogative is the possibility of entering the delay times in musical notation rather than in milliseconds, with a value expressed as B.P.M. or beats per minute as reference.

Structurally, the delay line has been subdivided into two parts, thus producing 2 separate stereophonic delays, each with its own parameters. The parameters of the two delays, which are absolutely identical, will be described together.

A 001 Roarin'Gtr	DLY - METRONOME 2
▶ BPM : 120	
▶ DELAY 1 ▶ NOTE 1/16	▶ F.BACK █ 25
▶ PAN L 50 R 50	▶ LEVEL █ 30
▶ DIRECT █ 100	
▶ MASTER █ 96	
█ █ █ █ █ █	

BPM parameter. Range: 30 - 250

BPM indicates the number of beats per minute: in our case, they are assumed always to be crotchets. The parameter is used to set the delay time on the basis of the metronome speed of the song.

Delay parameter. Range: 1 - 2

Selects on which of the two lines the modifications are to be made.

Pattern Notes : Value parameter. Range: 1/4•, 1/4, 1/8•, 1/4T, 1/8, 1/16•, 1/8T, 1/16, 1/32•, 1/16T, 1/32, 1/64•, 1/32T, 1/64, 1/128•, 1/64T, 1/128, 1/128T, OFF (where • represents a dotted triplet).

Selects the musical notation to be used for creation of the delay effect.

F.Back parameter. Range: 0 - 100

Regulates the quantity of signal returned to the input of the delay line selected thus the time before the repetitions cease.

Pan parameter. Range: L = 0 - 100 - R = 100 - 0

Determines the distribution of the selected line within the stereo front.

Level parameter: Range 0 - 100

Sets the output level of the selected delay line.

Direct parameter. Range: 0 - 100

Regulates the level of the input signal.

Master parameter. Range: 0 - 100

OBERHEIM GM 1000
Digital Signal Processor

Regulates the level of the output signal in the context of the effects chain.

Control of the HOLD pedal.

The procedures described for the Tap Delay apply.

Control of the TAP pedal.

The procedures described for Metronomic delay 1 apply.

6.9 REVERB (REV)

THE REVERBERATION EFFECT

This effect is of fundamental importance and so we will describe it in greater detail than the previous effects. Reverberation is the result of a series of sound reflections. The order and value of each reflection depends on the ambient in which it occurs. There are many factors in play within any one room or hall, such as the dimensions of the place where the phenomenon occurs, the nature of the material of which it is constructed and the objects it contains, and the position of the listener. We will look at this concept in greater depth by analyzing the 3 main components of natural sound together.

Direct sound: in practice, this is the sound emitted by the sound source which reaches our ears directly without ever being reflected. If the value of this parameter is high, except for rare exceptions the sound source and the listener are close to each other.

Early reflections: the sound is reflected a few times before it reaches our ears. The distance and the frequency with which these reflections occur are closely linked to the dimensions of the ambient in which they take place.

Late reflection - reverberation: before reaching and surrounding us, the sound has been broken down countless times in the environment, acquiring a suffused, dense nature which also depends on the material of which the ambient consists.

The sound which reaches our ears is therefore a complex blend of these fundamental elements.

REVERB

Reverb is the classical ambient effect with two separate parts, which can be positioned separately within time: early reflections and reverberation, or late reflection.

A 001 Roarin'Gtr	REV - REVERB
▶ TYPE ; LARGE HALL	
▶ REV TIME (Sec.) 1.4	▶ DIRECT 100
▶ PRE-DELAY (ms) 0	▶ EFFECT 25
▶ HI DAMP 18K	▶ MASTER 100
PAGE	
█ █ <input type="checkbox"/> █ █ █	

Type parameter. Range: Large Hall, Medium Hall, Large Room, Small Room, Chamber, Plate, Spring.

OBERHEIM GM 1000

Digital Signal Processor

The Type parameter sets the type of reverb and/or the size of the room whose response is to be simulated. The differentiations are obtained by controlling a large number of internal parameters, such as delays and relative amplitude of the early reflections part, and the lengths and gains of the modules which make up the reverberation part.

Rev Time parameter. Range: 0.1 - 20.0 seconds with step of 0.1 secs

Controls the duration of the reverb.

Pre-Delay parameter. Range: 0 - 100 sec.

This parameter sets the reverb delay time.

Hi Damp parameter. Range: None, 20K, 19K, 18K, 17K, 16K, 14K5, 12K5, 11K5, 10K, 9K, 8K, 6K35, 5K05, 4K, 2K, 1K

Displays the cut-off frequency of a filter which eliminates all the frequencies higher than the one set.

Direct parameter. Range: 0 - 100

Regulates the level of the input signal.

Effect parameter: Range 0 - 100

This parameter regulates the quantity of the effect.

Master parameter. Range: 0 - 100

Regulates the level of the output signal in the context of the effects chain, in this case the sum of the processed sound and the direct sound, mixed by means of the EFFECT LEVEL and DIRECT LEVEL parameters.

A 001 Roarin'Gtr	REV - REVERB
EARLY REFLECTIONS	▶ PRE-DELAY (mS) 0
	▶ LOW PASS 12K7
	▶ MIX LEVEL 28
PAGE	
<div style="display: flex; justify-content: space-around; width: 100%;"> <div style="width: 20px; height: 10px; background-color: black;"></div> <div style="width: 20px; height: 10px; background-color: black;"></div> <div style="width: 20px; height: 10px; background-color: white; border: 1px solid black;"></div> <div style="width: 20px; height: 10px; background-color: black;"></div> <div style="width: 20px; height: 10px; background-color: black;"></div> <div style="width: 20px; height: 10px; background-color: black;"></div> </div>	

- **N.B.:** the second editing page cannot be selected if the Type parameter on the first page is set on Plate or Spring.

Early Reflections PreDelay parameter. Range: 0 - 100 msec.

This parameter controls the delay of the early reflections.

Early Reflections Low Pass parameter. Range: OFF, 16k, 12k7, 10k, 8k, 6k3, 5k, 4k, 3k1, 2k5, 2k.

OBERHEIM GM 1000

Digital Signal Processor

Regulates the attenuation frequency of the high tones in the early reflections.

Early Reflections Mix Level parameter. Range: 0 - 100

Regulates the quantity of early reflections in the effect.

A 001 Roarin'Gtr	REV - REVERB
REVERBERATION EQ	
LO SHELVE ▶ F(Hz) : 50	▶ B/C (dB) : + 0
MID PEAK ▶ F(Hz) : 100	▶ B/C (dB) : + 0 ▶ Q: 0.5
HI SHELVE ▶ F(Hz) : 12K	▶ B/C (dB) : + 0
PAGE	
<div style="display: flex; justify-content: space-around; width: 100%;"> <div style="width: 20px; height: 10px; background-color: black;"></div> <div style="width: 20px; height: 10px; background-color: black;"></div> <div style="width: 20px; height: 10px; border: 1px solid black;"></div> <div style="width: 20px; height: 10px; background-color: black;"></div> <div style="width: 20px; height: 10px; background-color: black;"></div> <div style="width: 20px; height: 10px; background-color: black;"></div> </div>	

Reverberation Eq Lo Shelve parameters.

Frequency Range: 50, 70, 100, 140, 200, 280, 400 Hz

Boost/Cut Range: +14db/-14dB

Reverberation Eq Mid Peak parameters.

Frequency Range: 100, 140, 200, 280, 400, 560, 800 1k0, 1k4, 2k0, 2k8, 4k0, 5k6, 8k0 Hz

Bandwidth (Q) Range: 0.5, 1, 2, 3

Boost/Cut Range: +14db/-14dB

Reverberation Eq Hi Shelve parameters.

Frequency range: 1k5, 2k1, 3k0, 4k2, 6k0, 8k5, 12k Hz.

Boost/Cut Range: +14db/-14dB

For this section, refer to the explanations supplied in the section on the parametric equalizer. These controls act on equalization of the late reflections (reverberation).

GATE REVERB

A reverb effect generally used with percussive sounds. Its main feature is that the background ambient effect is maintained at a given level for a certain period of time, after which it is cut off sharply, without the normal dying away noticed in ordinary reverb algorithms.

A 001 Roarin'Gtr	REV - GATE REVERB
▶ TYPE : RIGHT TO LEFT	
▶ REV TIME (ms) 150	▶ DIRECT 100
▶ PRE-DELAY (ms) 47	▶ EFFECT 30
▶ DENSITY 6	▶ MASTER 100
PAGE	
<div style="display: flex; justify-content: space-around; width: 100%;"> <div style="width: 20px; height: 10px; background-color: black;"></div> <div style="width: 20px; height: 10px; background-color: black;"></div> <div style="width: 20px; height: 10px; border: 1px solid black;"></div> <div style="width: 20px; height: 10px; background-color: black;"></div> <div style="width: 20px; height: 10px; background-color: black;"></div> <div style="width: 20px; height: 10px; background-color: black;"></div> </div>	

Type parameter. Range: Normal, LeftToRight, RightToLeft, Reverse.

The type parameter is used to select a conventional Gate, a Reverse Gate, or two effects of Panning between the channels.

Rev Time parameter. Range: 50 - 500 ms

Controls the duration of the reverb.

OBERHEIM GM 1000

Digital Signal Processor

Pre-Delay parameter. Range: 0 - 250 ms.

This parameter sets the effect delay.

Density parameter. Range: 0 - 10
Controls the density of the reflections.

Direct parameter. Range: 0 - 100

Regulates the level of the input signal.

Effect parameter: Range 0 - 100

This parameter regulates the quantity of the effect.

Master parameter. Range: 0 - 100

Regulates the level of the output signal in the context of the effects chain, in this case the sum of the processed sound and the direct sound, mixed by means of the EFFECT LEVEL and DIRECT LEVEL parameters.

A 001 Roarin'Gtr	REV - GATE REVERSE
ENVELOPE ▶ SHAPE: 4	▶ SLOPE : 7
E.R. LO SHELVE ▶ F(Hz) : 50	▶ B/C (dB) : + 0
MID PEAK ▶ F(Hz) : 100	▶ B/C (dB) : + 0 ▶ Q: 0.5
H I SHELVE ▶ F(Hz) : 12K	▶ B/C (dB) : + 0
PAGE	
█ █ █ █ █ █	

Envelope Shape parameter. Range: 1 - 4.

Envelope Slope parameter. Range: 0 - 10.

Envelope Shape allows the user to choose from 4 overall envelope shapes, while Envelope Slope controls their geometry. The diagrams which follow illustrate the 4 different Normal and Reverse shapes.

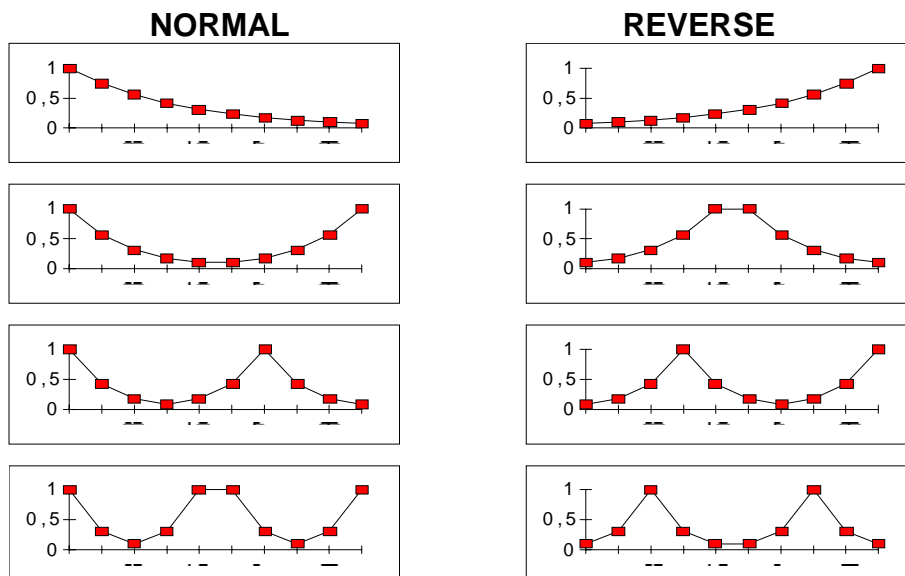

OBERHEIM GM 1000

Digital Signal Processor

Early Reflections Eq Lo Shelf parameters.

Frequency Range: 50, 70, 100, 140, 200, 280, 400 Hz

Boost/Cut Range: +14db/-14dB

Early Reflections Eq Mid Peak parameters.

Frequency Range: 100, 140, 200, 280, 400, 560, 800 1k0, 1k4, 2k0, 2k8, 4k0, 5k6, 8k0 Hz

Bandwidth (Q) Range: 0.5, 1, 2, 3

Boost/Cut Range: +14db/-14dB

Early Reflections Eq Hi Shelf parameters.

Frequency range: 1k5, 2k1, 3k0, 4k2, 6k0, 8k5, 12k Hz.

Boost/Cut Range: +14db/-14dB

For this section, refer to the explanations supplied in the section on the parametric equalizer. These controls act on equalization of the early reflections.

A 001 Roarin'Gtr		REV-GATE REVERB	
ACCENT	▶ LEVEL : 50	▶ DELAY : 8 (mS)	
DIR. LO SHELVE	▶ F(Hz) : 50	▶ B/C(dB) : + 0	
MID PEAK	▶ F(Hz) : 100	▶ B/C(dB) : + 0	▶ Q: 0.5
HISHELVE	▶ F(Hz) : 12K	▶ B/C(dB) : + 0	
PAGE			

Accent Level parameter. Range: 0 - 100

Regulates the volume level of a single repetition of the signal with the end of the early reflections pattern as time reference.

Accent Delay parameter. Range: 0 - 200 ms

Regulates the delay of the repetition known as "Accent" (see above) on both channels.

Direct Eq Lo Shelf parameters.

Frequency Range: 50, 70, 100, 140, 200, 280, 400 Hz

Boost/Cut Range: +14db/-14dB

Direct Eq Mid Peak parameters.

Frequency Range: 100, 140, 200, 280, 400, 560, 800 1k0, 1k4, 2k0, 2k8, 4k0, 5k6, 8k0 Hz

Bandwidth (Q) Range: 0.5, 1, 2, 3

Boost/Cut Range: +14db/-14dB

Direct Eq Hi Shelf parameters.

Frequency range: 1k5, 2k1, 3k0, 4k2, 6k0, 8k5, 12k Hz.

Boost/Cut Range: +14db/-14dB

For this section, refer to the explanations supplied in the section on the parametric equalizer. These controls act on equalization of the direct sound.

VIRTUAL CHAMBER

A reverberation effect which offers the user an interface in which he can define all the characteristics of the room to be simulated. For example, he can decide the size of the

OBERHEIM GM 1000

Digital Signal Processor

room and the absorption capacity of its walls, the position of the sound source, and the listener's position and the direction in which he is facing. Setting these programming parameters will enable you to create surprising effects, absolutely beyond the capabilities of normal reverbs: the GM 1000 will introduce you to the world of "psycho-acoustics", normally the domain of extremely expensive sound processors used only by large recording studios.

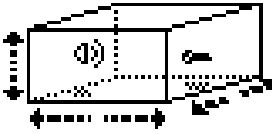
A 001 Roarin'Gtr		REV-VIRT CHAMBER	
CHAMBER	WIDTH	6 M	
	DEPTH	11 M	
	HEIGHT	4 M	
▶ MASTER		95	
PAGE			

Chamber Width parameter. Range: 1 - 40 metres

Chamber Depth parameter. Range: 1 - 40 metres

Chamber Height parameter. Range: 1 - 20 metres

They set the dimensions (in metres) of the reverberation chamber to be simulated.

Master parameter. Range: 0 - 100

Regulates the level of the output signal in the context of the effects chain.

A 001 Roarin'Gtr		REV-VIRT CHAMBER	
SOURCE	▶ X: 1 M	▶ Y: 2 M	
LISTENER	▶ X: 1 M	▶ Y: 11 M	▶ Δ: Human
	▶ ORIENTATION	180°	
	▶ SPREAD	+ 0°	
PAGE	▶ SHOOTING	40°	

Source X parameter. Range: 0 - Chamber Width

Source Y parameter. Range: 0 - Chamber depth.

These two parameters set the position of the sound source inside the reverberation chamber.

Listener X parameter. Range: 0 - Chamber Width

Listener Y parameter. Range: 0 - Chamber depth.

They set the positioner of the listener inside the reverberation chamber.

Listener D parameter. Range: 0, Human, 1 -min (Width, Depth) with step 1 metre

Regulates the distance between the left and right listening points. This parameter is useful above all when a microphone recording is to be simulated.

Listener Orientation parameter. Range: 0° - 360° Step 5°

Sets the direction in which the listener is facing in a range from 0° to 360° at intervals of 5°.

OBERHEIM GM 1000

Digital Signal Processor

Listener Spread parameter. Range: -90° - 90° . Step 5°

They regulate the angle of spread of the listening process. Positive angles indicate an outward extension of the spread. The values range from -90° to 90° at intervals of 5° .

Listener Shooting parameter. Range: 0° - 360° . Step 5°

Regulate the listening pick-up angle in a range from 0° to 360° at intervals of 5° .

The last three parameters set the virtual polar diagrams of the listening points. The two diagrams which follow show two examples intended to make the use of these controls simpler.

The first example refers to simulation of use of microphones, while the second simulates listening by a human being.

In the examples, the Orientation value is positive while the Spread is negative.

In case of simulation of use of microphones.

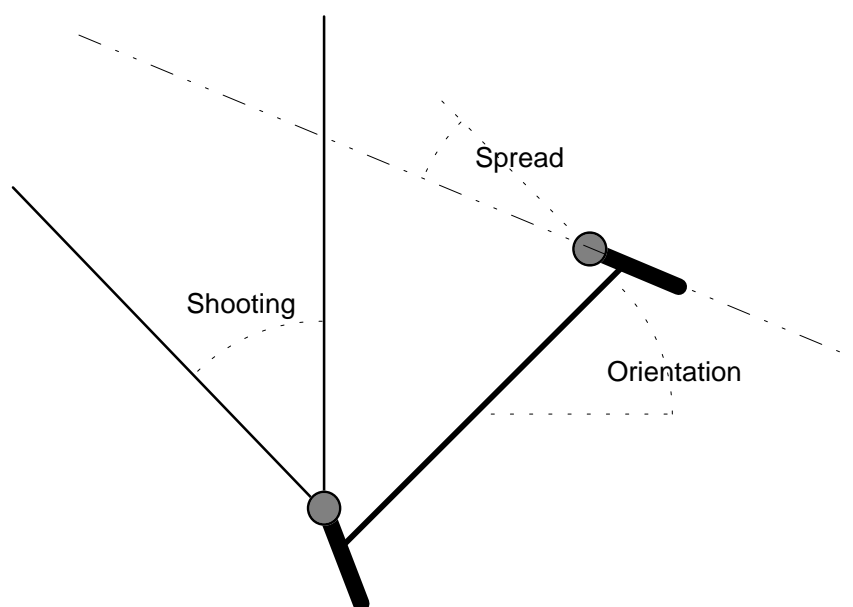

In case of simulation of listening by a human being.

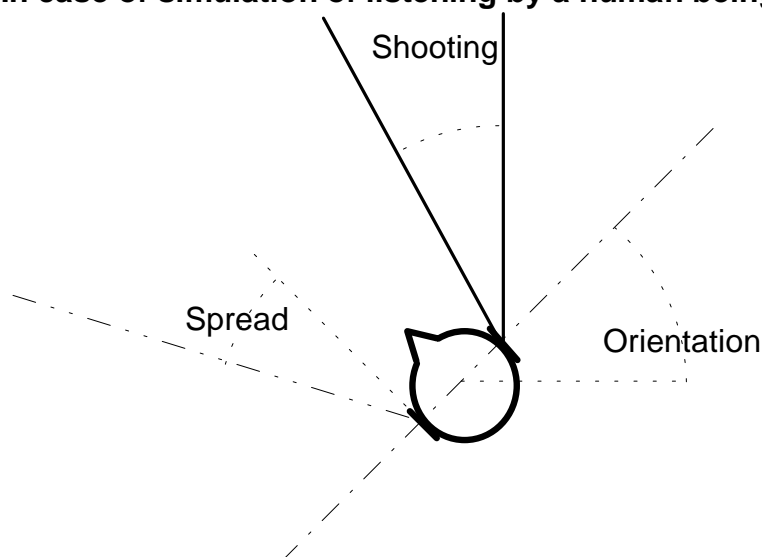

OBERHEIM GM 1000

Digital Signal Processor

A 001	Roarin'Gtr	REV-VIRT CHAMBER
CHAMBER	▶ WALL: SOUTH	▶ ABSORPTION 3
	▶ HI DAMP	18K
▶ LISTENER: EARS		
▶ PARALLEL	████████████████████	73
PAGE	████	████

Chamber Wall parameter. Range: North, South, East, West, Ceiling, Floor.

This parameter selects the wall (or floor or ceiling) of which the absorption is to be regulated using the ABSORPTION parameter.

Chamber Absorption parameter. Range: 0 - 10

Regulates the quantity of absorption of the wall chosen using the WALL parameter. The kind of materials of which the room is constructed have considerable influence on the duration of the reverb. This parameter sets out to simulate the consistency of various materials which will then give different reverb durations.

Chamber Hi Damp parameter. Range: None, 20K, 19K, 18K, 17K, 16K, 14K5, 12K5, 11K5, 10K, 9K, 8K, 6K35, 5K05, 4K, 2K, 1K

Displays the cut-off frequency of a filter which eliminates all the frequencies higher than the one set from the reverb effect.

Listener parameter. Range: Mikes, Ears

Establishes the type of listener: pair of microphones or ears.

Parallel parameter. Range: 0 - 100

Interacts with the MASTER parameter to regulate the quantity of input sent to the output, parallel to the effect.

A 001	Roarin'Gtr	REV-VIRT CHAMBER
REVERBERATION EQ		
LO SHELVE	▶ F: 50 Hz	▶ B/C: + 7dB
MID PEAK	▶ F: 100 Hz	▶ B/C: + 0dB ▶ Q: 0.5
HI SHELVE	▶ F: 12K Hz	▶ B/C: + 0dB
PAGE	████	████

Reverberation Eq Lo Shelf parameters.

Frequency Range: 50, 70, 100, 140, 200, 280, 400 Hz

Boost/Cut Range: +14db/-14dB

Reverberation Eq Mid Peak parameters.

Frequency Range: 100, 140, 200, 280, 400, 560, 800 1k0, 1k4, 2k0, 2k8, 4k0, 5k6, 8k0 Hz

Bandwidth (Q) Range: 0.5, 1, 2, 3

Boost/Cut Range: +14db/-14dB

Reverberation Eq Hi Shelf parameters.

Frequency range: 1k5, 2k1, 3k0, 4k2, 6k0, 8k5, 12k Hz.

OBERHEIM GM 1000

Digital Signal Processor

Boost/Cut Range: +14db/-14dB

For this section, refer to the explanations supplied in the section on the parametric equalizer. These controls act on equalization of the reverberation effect created by Virtual Chamber.

6.10 NOISE GATE (NG)

The Noise Gate is at the end of the chain of effects and is always active. Its job is to eliminate the background noises generated by the preamplification effects such as compressors and distorters, or the hiss caused by very intensive equalization on the high frequencies. By its very nature, the Noise Gate acts by closing the audio circuit in the absence of an input signal, or in any case when its amplitude reaches very low audibility levels. It is therefore not able to eliminate noise present simultaneously with the signal. Since the level of noise produced by the GM 1000 effects is very low in any case, it can be envisaged that in many situations the Noise Gate can be set to intervene on very low threshold levels or even at level zero.

Threshold parameter. Range: 0 - 90

Sets the threshold below which the Noise Gate comes into operation.

Attack Time parameter. Range: 0 - 10

Sets the amount of time which will pass before the circuit is broken when the signal passes above the threshold set by the Threshold parameter.

Release Time parameter. Range: 0 - 10

Sets the amount of time which will pass before the circuit is closed when the signal falls back below the threshold set by the Threshold parameter.

• **SOME USEFUL HINTS**

- set the Threshold value starting from 0 and with no input signal present so that only the background noise generated by the effects parameter settings is cut out.
- finely adjust the Threshold parameter, also listening to how the effect behaves with an input signal present.
- set the Attack and Release values to your own personal taste, but where possible do not allow the effect to intervene too quickly (this also depends on the type of input signal).
- if there is no background noise, set the Threshold parameter on 0: the circuit will thus be included in the effects chain but will not have any effect.

6.11 THE MIDI FOOT CONTROLLER PAGE

This function can be used to set the parameters relating to use of the two optional pedal units which can be connected to the optional Oberheim FC 3000 remote control unit. A number of the effects parameters can be assigned to each of these two foot controllers, and can thus be controlled in real time. It is important to note that all these parameters have an exclusively local nature, so they can be freely assigned for each of the 384 memory locations available and saved in them.

OBERHEIM GM 1000

Digital Signal Processor

This video page is accessed from the main editing page by pressing the utility key (FTCTRL).

Foot Ctrl parameter. Range: 1, 2.

Selects one of the two pedals for which the parameters assigned are to be modified.

Group parameter. Range: CMP, DST, EQ, AMP, MOD, SP1, SP2, DLY, REV, NR, ---, OFF.

Sets the group in which the foot controller is to be used.

Parameter parameter.

Selects the parameter to be modified using the foot controller. In this case the range depends on the group selected, since as we have seen in EDIT MODE, the parameters often vary widely from one group to another.

Range parameter

Sets the range of action for modification of the parameter. If the value entered in the first parameter is lower than that of the second, reversed or negative effects curves can be obtained. Here again, the range of values depends on the parameter selected.

- **N.B.:** *a midi control change can also be assigned to each pedal.*

OBERHEIM GM 1000
Digital Signal Processor**7. UTILITY MODE**

This section discusses a number of utility functions available on the GM 1000. The procedures for use of these functions using the CURSOR keys, the VALUE encoder and the EDIT/EXIT keys are as described in the previous points. These functions are accessed by pressing the UTILITY key (light on) with the main menu page on the screen.

7.1 MIDI SETTINGS

Midi in 1 and 2 parameter. Range: OFF, 1, 2, 3, 4, 5, 6, 7, 8, 9, 10, 11, 12, 13, 14, 15, 16, OMNI.

Allows the user to set the Midi reception channel. The OFF value cuts out reception while the OMNI setting enables all 16 Midi channels simultaneously.

Midi Out parameter. Range: OFF, 1, 2, 3, 4, 5, 6, 7, 8, 9, 10, 11, 12, 13, 14, 15, 16.

Allows the user to set the channel for transmission of the Midi data generated by the GM 1000. The OFF value cuts out reception.

Device Id parameter. Range: 1, 2, 3, 4, 5, 6, 7, 8, 9, 10, 11, 12, 13, 14, 15, 16,

Allows the user to set the device identification number (from 1 to 16) if more than one GM 1000 devices are used connected by means of Midi connectors, in order to differentiate their reception of the System Exclusive (Sys Ex) data.

Prg parameter. Range: STD, TABLE

Sets whether or not the GM 1000 is required to respond to program change messages in the standard way or by means of the mapping which can be defined by the user, described in the PROGRAM TABLE section.

Filters on parameter. Range: IN1, IN2, OUT.

Allows the user to select the outgoing and incoming messages to be filtered by means of the PRG, CTRL, SYSEX and CLOCK parameters in the same video page.

Program (PRG) parameter. Range: ON, OFF.

Enables or disables reception/transmission of memory patch changes (also depending on the value set in the FILTERS ON parameter). When the parameter is set as ON, the GM 1000 is able to respond to program changes.

Control (CTRL) parameter. Range: ON, OFF.

OBERHEIM GM 1000

Digital Signal Processor

Enables or disables reception/transmission of continuous controls in real time (also depending on the value set in the FILTERS ON parameter). When the parameter is set as ON, the GM 1000 responds to this type of command.

Sys Ex parameter: Range, ON, OFF, ALL (ON, OFF).

Enables or disables reception/transmission of exclusive system Messages which allow data exchanges or communications with the optional Oberheim FC 3000 remote control (also depending on the value set in the FILTERS ON parameter). Select ON to activate the sys ex exchange function.

Clock/Panel parameter. Range: ON, OFF.

The Clock parameter present when the value selected for FILTERS ON is IN allows the user to enable or disable reception of the Midi Realtime Clock, meaning the control which allows Midi synchronization of the BPM parameter of the Metronome Delay effect. When the FILTERS ON value is OUT the Panel function becomes available and replaces the Clock parameter on the display. With the Panel parameter on ON any operation performed on the GM 1000 panel is encoded and made available in the form of exclusive system messages in the MIDI OUT output. One use of this function may be to allow a series of editing operations to be saved by Midi on a sequencer, ready for review later on the LCD display or playback during a performance together with the musical sequence, to give a visual check on the modifications made to it. It is also possible to insert modifications to the sound in a performance in real time, in a way similar to the procedure used for the analogue synthesizers without memory in use in the 'Seventies. However, in this case the changes are made automatically without interfering with the musician's performance, at the correct time and with mathematical precision, by a Midi digital system, which even allows an immediate visual check on the modifications on the display.

- **CAUTION !!:** *for correct recording and playback of a sequence which contains video page changes, the main video page must appear on the GM 1000 screen in PLAY MODE. This must be remembered both when starting to record and when playing back.*

Fc1 and Fc2 parameters. Range: Y, N (Y=yes, N=no)

These set whether or not the foot controllers are to be active. The bypass key can be used to activate (ball solid) or deactivate (ball hollow) one or two foot controller(s), obtaining all the possible combinations in succession.

The second edit page contains:

BYPASS, FC1, FC2, TUNER, CMP, DST, EQ, QMP, MOD, SP1, SP2, DLY, REV parameters. Range: 0 - 31, 64 - 119.

With these parameters, the user can set the Control Change value which will activate the Bypass function if selected, the function assigned to Foot Controller 1 and 2 (programmed in the Midi Foot Controller page, to which users should refer for any explanations), or activate or disable one group in the effects chain.

Preset function.

OBERHEIM GM 1000

Digital Signal Processor

When the compare (Preset) key is pressed, the CONTROL CHANGE NUMBER parameter values set in the factory are restored. This control allows the user to create a good starting point for his own modification sessions.

7.2 PROGRAM TABLE

This function allows the user to make a specific Program Change number sent by Midi recall any one of the 512 memory locations available. In other words, the user can make Program Change n. 23 correspond to location 64 or 87 and not to location 23 as would be the case under the conventional Midi logic. This function is very useful when using the optional Oberheim FC 3000 remote control unit, since it makes it possible to concentrate the recall of a series of 10 memory locations chosen as the user wishes, which can all be reached immediately in PROGRAM MODE by just pressing one of the number buttons on the unit (see the foot controller user manual). This avoids time-wasting leaps between numbers or banks when the selection is made during a live performance.

Program Change Nr parameter. Range: 1 - 128

Allows the user to set the number of the Program Change to be used.

Location Bank parameter. Range: A, B, C

Allows the user to select the Bank with the memory location to be associated to the Program Change.

Location N. parameter. Range: 1 - 128

Allows the user to select the memory location to be associated to the Program Change.

Name.

Shows the name of the memory location currently associated to the selected Program Change.

- **CAUTION !!:** *To be able to use the table of Program Changes set by the user, the MIDI UTILITY PRG function must be switched to TABLE mode (as described in the previous point).*

7.3 DUMP

The Midi Dump function allows the user to transfer the entire contents of the GM 1000 memory, or only a part of it, to a remote data storage device (computer, sequencer or data filer) connected to the Midi Out socket. This utility thus allows the user to preserve the valuable programming work carried out on the device. The GM 1000 has a selective Dump function, which permits selection in the tiniest detail of the exact part of the memory's contents to be copied.

Bank parameter. Range: A, B, C, ALL

OBERHEIM GM 1000

Digital Signal Processor

Allows the user to set the bank(s) with the location(s) to be transferred. With ALL, all the banks will be transferred together.

Location parameter. Range: 1 - 128, ALL

Allows the user to set the number(s) of the memory location(s) to be transferred. Naturally, when ALL is selected all the locations of a bank will be transferred together.

Group parameter. Range: CMP, DST, EQ, AMP, MOD, SP1, SP2, DLY, REV, ALL.

Allows the user to select the Group(s) to be transferred within the selected memory location. Naturally, ALL includes all the groups.

As the message on the LCD indicates, once the parameters required have been selected and the correct Midi connections have been made, the user simply starts the operation by pressing ENTER/WRITE.

- **N.B.:** *the data Dump is also carried out if the Group selected is deactivated or in Bypass status.*

The procedure for reloading the saved patches is very simple: just send the data to the GM 1000 through the Midi In socket when the display is showing the PLAY MODE: the multieffects unit will reply with a message which shows that data reception is in progress.

7.4 MIDI MONITOR

The MIDI MONITOR function enables the flow of the MIDI data arriving on the MIDI in 1 or 2 sockets of the GM-1000 to be seen on the display.

The practicality of such a function will be appreciated every time it is necessary to control the data transmitted by any MIDI unit: as the GM-1000 interpretes the data and also relays the type by writing in the display beside the value, it is very easy to distinguish note messages from control messages or clock messages, System exclusive etc.

To visualize Midi data received:

- Connect the MIDI IN1 or 2 socket of the GM-1000 to the MIDI OUT socket of the MIDI unit that is going to send the data.
- Select MIDI MONITOR in the UTILITY MODE display with the CURSOR keys or the VALUE knob.
- Observe the flow of data

To momentarily block the visualization:

- Press the key under PAUSE (local BYPASS)

To clear the display:

- Press the key under CLEAR (ENTER/WRITE)

To exclude the real time messages from the visualization:

- Press the key under RT OFF (EDIT)
- Press the key under RT ON (EDIT) to reactivate the function

OBERHEIM GM 1000

Digital Signal Processor

8. TOOLS

8.1 TUNER

In practice, this Tool is a digital tuner which can be used to check the tuning of an input signal.

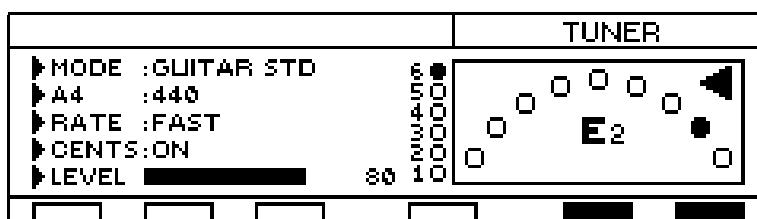

Mode parameter.

Selects the tuning mode. There are 12 operating options to cover the most widely varying uses.

CHROMATIC: suitable for any use.

GUITAR STD: standard guitar tuning

12ST OCT UP: for 12 string guitars, tunes the double strings in the octave above.

GUITAR FLAT: guitar tuning half a tone flat.

GTR D FLAT: guitar tuning a whole tone flat.

6-STR.BASS: tuning for 6-string bass.

5-STR.BASS: tuning for 5-string bass.

4-STR.BASS: tuning for 4-string bass.

OPEN G: open G major tuning

OPEN D: open D major tuning

OPEN Em: open E minor tuning

Dropped D: guitar tuning with the 6th string one tone flat (D).

- **CAUTION !!:** *the use of an instrument other than the one specified in the MODE parameter as input may lead to inaccuracies in evaluation of the tuning.*

A4 parameter. Range: 435 - 445

Allows the reference frequency of middle A to be varied.

Rate parameter. Range: SLOW, FAST

Regulates the speed of response and of display of the minimal variations in tuning of the input signal. The SLOW setting is very useful for tuning wind instruments or any instrument which does not have preset tuning.

Cents parameter. Range: ON, OFF.

Activates or deactivate real time numerical display of the hundredths of a tone above or below perfect tuning.

OBERHEIM GM 1000

Digital Signal Processor

Level parameter. Range: 0 - 100

Sets the level of the output signal. When set at zero, this parameter allows the user to tune the instrument without an output signal at the OUT connector, so that other musicians or listeners are not disturbed.

Graph.

To tune, send a sound to the GM 1000 and adjust the instrument's tuning until it is perfect.

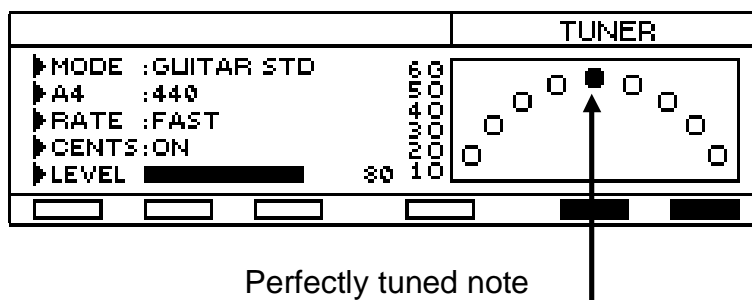

8.2 ANALYZER

The Tool called ANALYZER is able to transform the GM-1000 into a real 31-BAND spectrum analyzer.

By connecting a good quality microphone to the GUITAR INPUT socket on the front panel or a line signal to the rear INPUT L&R, it is in fact possible to carry out a real time analysis of the frequency content of the input signal.

One of the main applications that this function of the GM-1000 is destined to perform is without doubt the frequency response measurement in environments of audio amplification systems.

In fact is possible, by means of the spectrum analyzer, to visualize the analysis in realtime, 'freeze' it once an average value has been certified, save it in one of the 14 slots available and compare it at a later time with the analysis of different situation.

The GM-1000 will therefore be able to visualize on the display all the corrections made on the 31-band Graphic equalizer of the amplification system to make the actual response of the installation as close as possible to another, used as comparison.

With the exception of the equalizer in the amplification, the implementation of functions available in the spectrum analyzer of the GM-1000 makes it completely self-sufficient.

To recall the ANALYZER FUNCTION

- While in play mode press ANALYZER in the TOOLS section

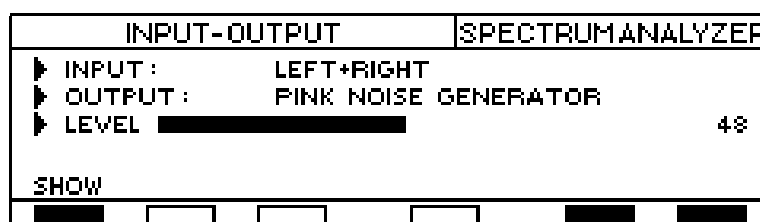

OBERHEIM GM 1000

Digital Signal Processor

SETTING THE PARAMETERS:

By pressing ANALYZER in the TOOLS section the initial settings are shown in the display; these are:

- INPUT: Selects the input or the sum of inputs from which the signal to be analyzed will be taken
- OUTPUT: Activate the generation of the control signals (Pink noise or Sweep), the monitoring of the input signal or the MUTE condition.
- LEVEL: Sets the level of the internally generated signal or those monitored externally.

N:B. When the display is recalled, the Analyzer function is automatically set in BYPASS. The reason for this is that the Analyzer, like all the control software section of GM 1000, "memorizes" the settings made by the user at the time of the last recall. In the probable case that the last tests involved the use of a function that generated a high volume control signal, an unexpected emission of this signal could happen, with dangerous consequences for the user's hearing. To avoid this happening, the analyzer function must be activated manually by the user each time.

To activate the analyzer:

- Select the initial options of the INPUT and OUTPUT parameters.
- Set the LEVEL parameter to values close to zero
- Press the BYPASS (local) key under the display

To begin the real time analysis:

- With the introductory page of the Spectrum Analyzer showing, press SHOW (edit)

The display will now graphically show the real time analysis of the 31 bands. The parameters T (TOP) and R (RANGE) both expressed in dB, should be noted: these respectively set the maximum level and the range of the bars in the display.



The press FREEZE (Edit) to block the analysis. By rotating the VALUE knob it will also be possible to obtain a numerical reading of the results of the analysis for each of the 31 bands.



OBERHEIM GM 1000

Digital Signal Processor

By pressing TEMPLT (Edit) it is possible to select one of the 15 memories (Template) which hold the relative data of the spectrum analyzer:

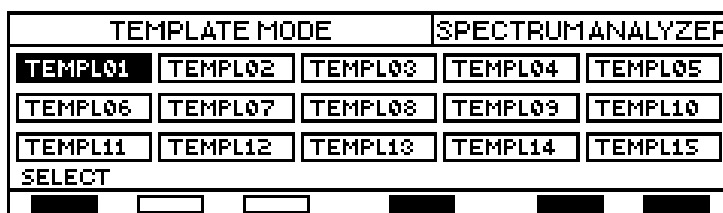

After selecting the Template with the VALUE knob, press WRITE to save the results of the analysis or SELECT (Edit) to compare the current analysis with that in the memory selected (by default, all the Template memories are empty)

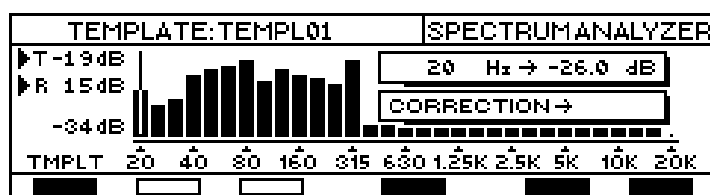

Proceeding with the analysis, the display will show the contents of the analysis present in the Template taken as a reference; by means of the VALUE knob, it is possible to read the corrections that has to be made for each band, in order to obtain a frequency response equal to that memorized in the template.

9. TIPS AND TRICKS

This section of the manual contains some Tips and Tricks to help you use GM 1000 Multi effects unit to the best of its capabilities.

9.1 Levels and digital technology

The GM 1000 is a totally digital unit: this characteristic means being aware of certain particulars during the programming.

With a difference to analog technology, digital technology does not recognize compromises as far as the flexibility of the audio signal is concerned.

In a digital system the maximum dynamic level is 0 dB ; above this threshold, even if exceeded for an instant, the so called "digital distortion" sets in.

Digital distortion is not to be confused with the that normally requested by guitarists, and produces an unpleasant effect, that is almost identified as an abnormality in the working of the unit.

As each filter in the GM 1000 can intervene within a range of ± 14 dB and its possible to superimpose the effect of more than on filter at a time, it can happen that the threshold of 0 dB is exceeded.

For this reason it is necessary that all the programming of any effects is carried out bearing in mind the gain in amplification that the effect produces.

In order to realize what percentage of gain is introduced by a selected effect, you are advised to use the LOCAL BYPASS function (under the display) extensively, comparing the difference in the levels with and without the effect.

It is advisable to set the master level of each effect so that the total gain is never excessive and is never much more than that with the effect bypass.

To control eventual digital distortion at the input

- Use the GUITAR INPUT LEVEL control on the front panel

N.B. *The last two led segments in red indicate when the signal exceeds the threshold of 0 dB. Due to the extreme speed at which the unit measures the level, the momentaneous lighting of these red leds on the signal peaks can be considered normal and will not create any audible digital distortion.*

On the other hand, any digital distortion introduced by an effect along the elaboration chain can become audible even in the case of a perfect setting of the input signal level

To control eventual digital distortion introduced while programming an effect

- With the EFFECT EDIT display showing during the programming, press BYPASS (local) under the display
- Set the parameter to a lower level
- Check the LEVEL parameter of all the effect involving pre-amplification (CMP, DST, EQ, AMP groups)

9.2 Programming

Fine control of the timbre

To be able to finely control the timbre of the instrument or the desired distortion, try experimenting with the COMB FILTER effect in the SP-1 group. This, in fact, excites the harmonics and will prove to be very useful for the imitation of particular sounds or to create a patch with characteristically personalized sounds.

A short cut

It is possible to accede to an effect selected in a Group in a direct manner (bypassing the intermediate display or displays) when in the first EDIT MODE display (Patch edit), that shows the route of the elaborated signal, by pressing the relative Group key.

The merging of two patches

You can merge effects coming from two different memory locations by using the following procedure:

1. Memorize the two patches to be merged in adjacent locations or in locations with the same number but in different banks: for example C121 and C122 or C121 and D121: for convenience the first patch is called SOURCE and the second DESTINATION.
2. Check that all that contain the effects to be taken from the SOURCE patch are active or in Bypass: if this not so, correct the condition and save in the same location number.
3. Resave the DESTINATION patch, making sure to deactivate all the groups will receive the effects that you need to transport (do not set in BYPASS)
4. Recall the SOURCE patch and straight afterwards the DESTINATION patch without passing through of the second
5. At this point you will have in memory a patch that contains the effects of the first plus those of the second
6. Activate in the DESTINATION patch all the groups that contain the new effects coming from the SOURCE patch and save everything in a third location of your choice.

9.3 Writing the patches

Fast memorizing of a patch

You can memorize a modification made in a patch by simply pressing the EDIT/WRITE key twice.

OBERHEIM GM 1000

Digital Signal Processor

How to copy the name of a patch

It is possible to copy the name of the source patch (besides its contents obviously) in to the DESTINATION patch with the following sequence ENTER/WRITE - NAME (Utility) - VALUE knob (to select the destination) - ENTER/WRITE.

Foot controller programming

It can happen that one or both the Foot Controllers are shown to be assigned to the WHA effect on the SP-1 group, even though it is in Bypass or deactivated. In this case it is not possible to intervene on the assignment parameters in the MIDI FOOT CTRL page.

To obviate this inconvenience it is sufficient to select a different effect in the SP-1 group by following this procedure: EXIT, SELECT SP-1, SELECT any effect other than WHA, press EXIT twice and repeat the operations.

10. INITIALIZATION PROCEDURE

The GM 1000 control software is very complex and its programming and optimization has required a considerable effort.

Every condition of use of the device has been analyzed, reproduced and verified, but it is impossible to ensure that unpredictable external factors such as magnetic fields or serious mains power disturbances will not impair its operation in specific situations.

For this reason, a number of special functions are grouped together in two video pages which can only be accessed using a special procedure to be used when the GM 1000 is switched on.

10.1 FACTORY SETTINGS

To access the GM 1000 multieffects unit initialization procedure, switch on the device keeping the EDIT and ENTER/WRITE keys simultaneously.

The service video page will offer the following functions:

CLEAR WORK VARIABLES: to be used only if the system becomes blocked (PANIC). The basic values of a number of parameters of the control software will be restored if the contents of the memory have been contaminated due to errors of any kind. This operation does not modify the contents of the data saved by the user in the patches.

BANK TO CLEAR: causes the total loss of the contents of the patches memorized in the selected bank. Restores the original conditions of the memory contents, recovering the 128 patches programmed in the factory and recopying them into one or more of the 3 banks selected with [Y].

- **CAUTION !!:** *Only use if the machine cannot be restored to correct operation in any other way.*

10.2 DSP SELF-TEST

The page described in the previous point contains a Self-Test or self-diagnostics page. This page shows the result of a self-test performed by the GM 1000 on the operation of its own digital signal processors, responsible for generating the effects.

- **CAUTION!!!:** *this section of the control software should only be used by the staff of authorized Oberheim service centres.*

OBERHEIM GM 1000

Digital Signal Processor

11. ANNEX

11.1 THE TYPES OF CONNECTORS USED

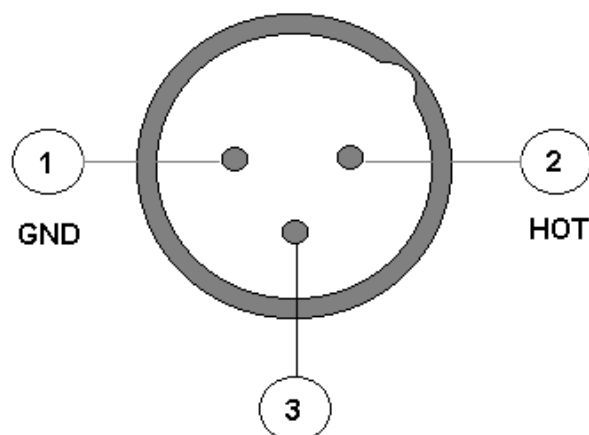
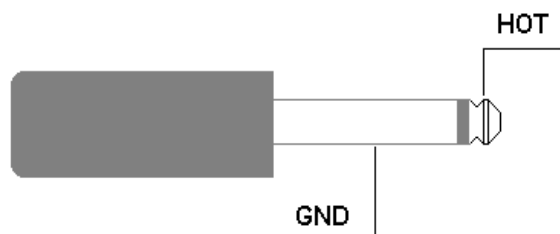

Unbalanced 6.3 mm jack connector

Used for the following sockets:

Inputs L/Mono,R - rear

Outputs L/Mono,R - rear

Guitar Input - front

Balanced Xlr Cannon connector

Used for the following sockets:

Inputs L/Mono,R - rear

Outputs L/Mono,R - rear

11.2 GLOSSARY OF TERMS USED

- **Bypass.** As its name suggests, allows the user to listen to the sound with and without one or more sound modification effects, in order to make comparisons.
- **Compare:** procedure for comparing two sounds. Normally used during editing to verify the quality of the changes made.
- **dB:** abbreviation of Decibel, unit of measurement of acoustic pressure.
- **Display:** liquid crystal display which shows all the information for the man/device dialogue in graphic or text form.
- **Dsp:** abbreviation of Digital Signal Processor.
- **Edit:** function for modification of the device parameters.
- **Foot Controller:** type of pedal control unit. Allows commands to be given to the device while playing is in progress, and of course the performer's hands are busy.
- **Jack:** type of connection very widely used in the musical sector (see diagram on types of connectors used).
- **LED:** abbreviation of Light Emitting Diode. An electronic component which is widely used thanks to its reliability and low energy consumption.
- **Overload:** situation where a circuit is overloaded because the input signal is too high. The main cause of distortion.
- **Patch:** a combination of programming parameters which are saved in a memory location for instantaneous recall.
- **Play:** condition of use where the device is actually performing the music.
- **Pedal Switch:** pedal which acts as an on/off switch.
- **Utility:** utility function. These are often device setting and setup functions.

OBERHEIM GM 1000
Digital Signal Processor

12. TECHNICAL SPECIFICATIONS

AUDIO PERFORMANCE

DIGITAL SIGNAL PROCESSING:

2 CHANNEL A/D	18 BIT 102 dB 128 X OVERSAMPLING SIGMA DELTA
2 CHANNEL D/A	18 BIT 102 dB 64 X OVERSAMPLING SIGMA DELTA
DATA PATH	24 BIT 138 dB
MULTIPLIER	56 BIT 330 dB
SAMPLING RATE	44.1 KHZ
AUDIO BANDWIDTH	20-20.000 HZ +/- 1 dB

DSP

DYNAMIC DELAY MEMORY	192 KWORDS (4,46 s)
STATIC DELAY MEMORY	768 KWORDS (17,41 ms)
DATA ALU PROCESSING	33.9 MIPS
ADDRESS ALU PROCESSING	39.5 MIPS
MULTIPLIER SIZE	32 x 24 BITS

MEMORY CAPACITY

4 BANKS X 128 PROGRAMS = 512 TOTAL PROGRAMS

TOOLS

TUNER:

CONCERT PITCH A4	435-445 HZ
TUNING RANGE	10-C8
TUNING ACCURACY	+/-1 CENT
MODES	CHROMATIC, 4/5/6 STRINGS BASS, STANDARD GUITAR, OPEN G, 12 STRINGS GUITAR, OPEN D GUITAR FLAT, OPEN Em, GUITAR DOUBLE FLAT DROPPED E

INPUTS

GUITAR FRONT:

CONNECTOR	UNBALANCED JACK TS
INPUT IMPEDANCE	500 KOHM
INPUT SENSIBILITY	-12 DBM

LINE IN REAR (JACK):

CONNECTORS	(2x) UNBALANCED JACK TS
INPUT IMPEDANCE	50 KOHM
INPUT SENSIBILITY	-10 DBM

OBERHEIM GM 1000

Digital Signal Processor

LINE IN REAR (CANNON):

CONNECTORS	(2x) BALANCED CANNON XLR
INPUT IMPEDANCE	10 KOHM
INPUT SENSIBILITY	10 KOHM
INPUT SENSIBILITY	+4 DMB NOMINAL

MIDI IN:

CONNECTORS	DIN 5 PIN x 2
------------	---------------

OUTPUTS**PHONES:**

CONNECTORS	JACK STEREO TRS
OUTPUT LEVEL	22 MW (WITH LOAD =50 OHM)
OUTPUT LEVEL	30 MW (WITH LOAD = 200 OHM)

LINE OUT REAR (JACK):

CONNECTORS	(2x) UNBALANCED JACK TS
MIN LOAD IMPEDENCE	600 OHM
NOMINAL OUT LEVEL	-4 DMB

LINE OUT REAR (CANNON):

CONNECTORS	(2x) BALANCED CANNON XLR
MIN LOAD IMPEDENCE	600 OHM
NOMINAL OUT LEVEL	-10 DBM + 10 DBM

MIDI OUT:

CONNECTOR	DIN 5 PIN
MIDI THRU:	
CONNECTORS	DIN 5 PIN

OTHER CONNECTIONS

VOLUME:	CONTINUOUS PEDAL TRS
TAP TEMPO:	FOOT SWITCHES TS
HOLD:	FOOT SWITCHES TS

POWER SUPPLY

MAIN VOLTAGE (EUROPE)	230 V.A.C. 50 HZ
MAIN VOLTAGE (U.S.A.)	120 V.A.C. 60 HZ
POWER ASSORBTION	30 WATTS MAX
MAX VOLTAGE FLUCTUATION	+/- 15%

OBERHEIM GM 1000
Digital Signal Processor

MIDI IMPLEMENTATION CHART

Oberheim **GM 1000**
Digital Signal Processor

Date:03-Lug-96
Version: 1.33

FUNCTION ...		TRANSMITTED	RECOGNIZED	REMARKS
BASIC	DEFAULT	1	1	
CHANNEL CHANGED		1 - 16	1 - 16	
MODE	Default Messages Altered	Mode 3 X *****	Mode 3 Mode 3	
NOTE NUMBER	True Voice	X X	0 - 127 0 - 127	
VELOCITY	Note ON Note OFF	X X	O X	
AFTER TOUCH	Key's Ch's	X X	X X	
PITCH BENDER		X	X	
CONTROL CHANGE	7 64 66 67 91 93	O O O O O O	O O O O O O	Volume Hold Sostenuto Soft Reverb Chorus
PROGRAM CHANGE	True #	0 - 6	0 - 6	
SYSTEM EXCLUSIVE		O	O	Sound txfer
SYSTEM COMMON	Song Pos Song Sel Tune	X X X	X X X	
SYSTEM REAL TIME	Clock Commands	X X	X X	
AUX MESSAGES	Local On-Off All note Off Active Sense Reset	X O O X	X O O X	
NOTES:				

Mode 1: Omni On, Poly
Mode 3: Omni Off, Poly

Mode 2: Omni On, Mono
Mode 4: Omni Off, Mono

O = YES
X = NO

LITHIUM BATTERY WARNING

CAUTION! This product contains a lithium battery. There is danger of explosion if battery is incorrectly replaced. Replace only with a Maxell CR2 32.

Replace only with the correct polarity. Discard used battery according to manufacturer's instructions.

ADVARSEL! Lithiumbatteri – Eksplosjonsfare. Vade utskifting benyttes kun batteri som anbefalt av apparatfabrikanten. Brukt batteri returneres apparatleverand ren.

ADVARSEL! Lithiumbatteri – Eksplosjonsfare ved feilagtig handling. Utskiftning må kun ske med batteri av samme fabrikat og type. Lever det brukte batteri tilbake til leverand ren.

VAROITUS! Paristo voi r f ht , jos se on virheellisesti asennettu. Vaihda paristo ainoastaan laitevalmistajan suosittelemaan tyyppin. Hvit kytetty paristovalmistajan ohjeiden mukaisesti.

WARNING! Explosionsfar vid felaktigt batteribyte. Använd samma batterityp eller en ekvivalent typ som rekommendars av apparatillverkaren. Kassera anvnt batteri enligt fabrikantens instructions.

The information contained in this manual is subject to change at any time without notification. Some information contained in this manual may also be inaccurate due to undocumented changes in the product or operating system since this version of the manual was completed. The information contained in this version of the version of the owner's manual supercedes all previous version.

FCC RULES

NOTE: This equipment has been tested and found to comply with the limits for a **Class B** digital Device, pursuant to Part 15 of the FCC Rules. These limits are designed to provide reasonable protection against harmful interference in a residential installation. This equipment generates, uses and can radiate radio frequency energy and, if not installed and used in accordance with the instructions, may cause harmful interference to radio communications. However, there is no guarantee that the interference will not occur in a particular installation. If this equipment does cause harmful interference to radio or television reception, which can be determined by turning the equipment off and on, the user is encouraged to try to correct the interference by one or more of the following measures:

- Reorient or relocate the receiving antenna.
- Increase the separation between the equipment and receiver.
- Connect the equipment into an outlet on a circuit different from that to which the receiver is connected.
- Consult the dealer or an experienced Radio Tv technician for help.

The user is cautioned that any changes or modification not expressly approved by the party responsible for compliance could void the user's authority operate the equipment.

