

# PRODUCT INFORMATION

840nm

**1A239**  
High-Performance LED

**Datacom, General Purpose**

This device is designed for Ethernet and general applications and offers an excellent price/performance ratio for cost-effective solutions. Since it operates at low drive current, it generates minimal heat — reducing cooling requirements in systems employing large numbers of LEDs.

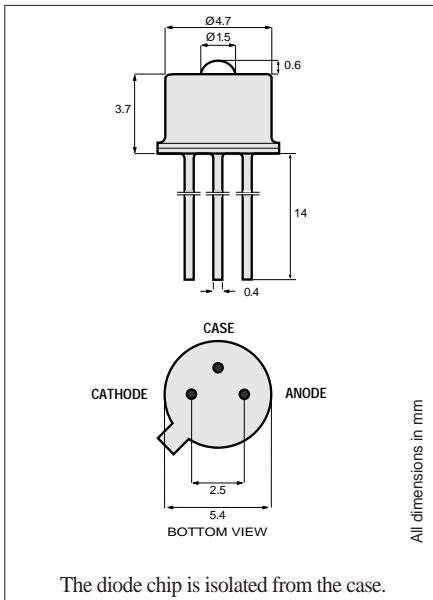

**TO-46 Package With Lens**

## Optical and Electrical Characteristics (25° C Case Temperature)

PARAMETER	SYMBOL	MIN.	TYP.	MAX.	UNIT	TEST CONDITION
Fiber-Coupled Power (Fig. 1, 2, & 3) (Table 1)	$P_{\text{fiber}}$	50	90		$\mu\text{W}$	$I_F=50\text{ mA}$ (Note 1,2) Fiber: 50/125 $\mu\text{m}$
Rise and Fall Time (10-90%)	$t_r, t_f$		7	10	ns	$I_F=50\text{ mA}$ (no bias) Graded Index
Bandwidth (3dB <sub>e</sub> )	$f_c$		50		MHz	$I_F=50\text{ mA}$ NA=0.20
Peak Wavelength	$\lambda_p$	820	840	860	nm	$I_F=50\text{ mA}$
Spectral Width (FWHM)	$\Delta\lambda$		50		nm	$I_F=50\text{ mA}$
Forward Voltage (Fig.5)	$V_F$		1.8	2.0	V	$I_F=50\text{ mA}$
Reverse Current	$I_R$			20	$\mu\text{A}$	$V_R=1\text{ V}$
Capacitance	$C$		250		pF	$V_R=0\text{ V}, f=1\text{ MHz}$

**Note 1:** Measured at the exit of 100 meters of fiber.

**Note 2:** 1A239A version with Fiber-Coupled Power > 80  $\mu\text{W}$  available on request.

## Absolute Maximum Ratings

PARAMETER	SYMBOL	LIMIT
Storage Temperature	$T_{\text{stg}}$	-55 to +125°C
Operating Temperature (derating: Fig.4)	$T_{\text{op}}$	-55 to +125°C
Electrical Power Dissipation (derating: Fig.4)	$P_{\text{tot}}$	130 mW
Continuous Forward Current ( $f \leq 10\text{ kHz}$ )	$I_F$	60 mA
Peak Forward Current (duty cycle $\leq 50\%$ , $f \geq 1\text{ MHz}$ )	$I_{\text{FRM}}$	100 mA
Reverse Voltage	$V_R$	1.5 V
Soldering Temperature (2mm from the case for 10 sec)	$T_{\text{sld}}$	260°C

## Thermal Characteristics

PARAMETER	SYMBOL	MIN.	TYP.	MAX.	UNIT
Thermal Resistance - Infinite Heat Sink	$R_{\text{thjc}}$			300	°C/W
Thermal Resistance - No Heat Sink	$R_{\text{thja}}$			600	°C/W
Temperature Coefficient - Optical Power	$dP/dT_j$		-0.4		%/°C
Temperature Coefficient - Wavelength	$d\lambda/dT_j$		0.3		nm/°C

11960.11 & .12 1996-01-23



Europe: Tel (46) 8 58 02 45 00 Fax (46) 8 58 02 01 10  
Tel (44) 1291 436180 Fax (44) 1291 436771

America: Tel 1-800-96MITEL Fax (613) 592-6909  
Asia: Tel (65) 293 5312 Fax (65) 293 8527

Typical Fiber-Coupled Power		
Core Diameter/Cladding Diameter Numerical Aperture		
50/125 $\mu\text{m}$ 0.20	62/125 $\mu\text{m}$ 0.275	100/140 $\mu\text{m}$ 0.29
90 $\mu\text{W}$	150 $\mu\text{W}$	250 $\mu\text{W}$

Table 1

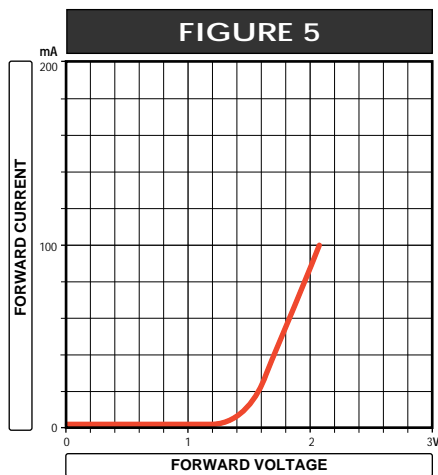
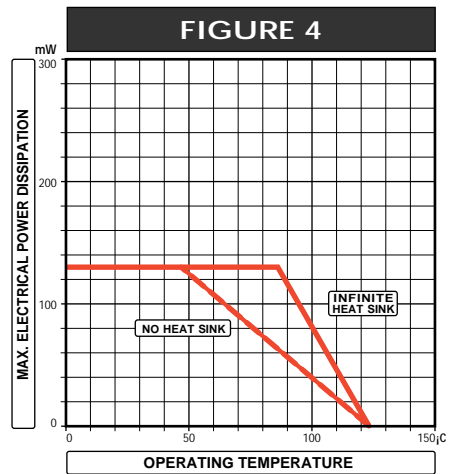
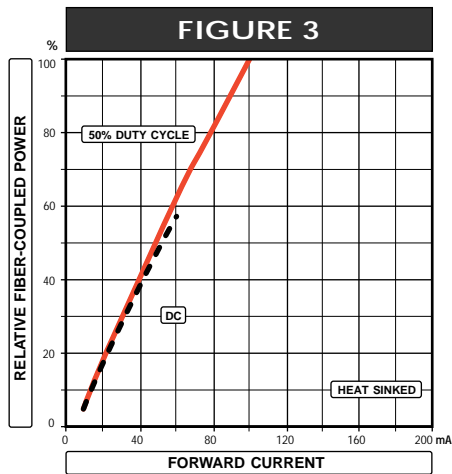
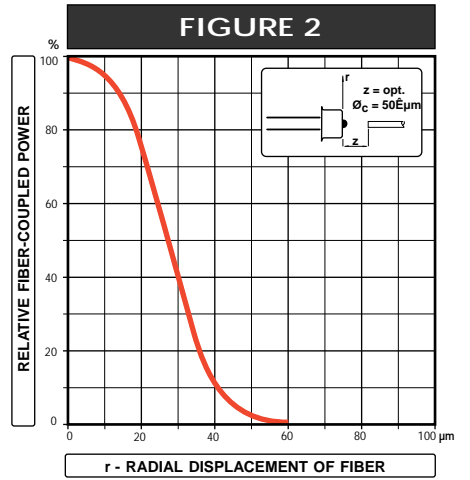
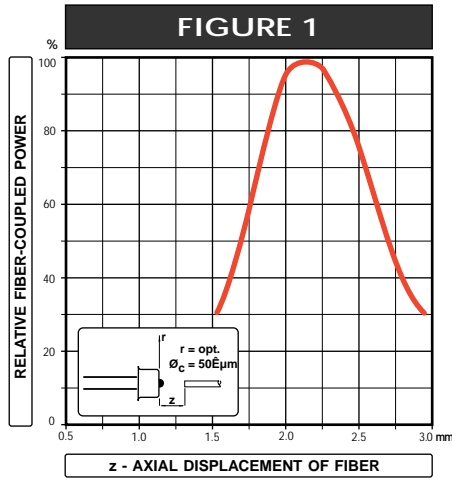

# Clip for SC-2A

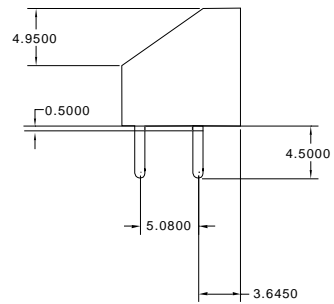

# Clip for Pigtail-3A

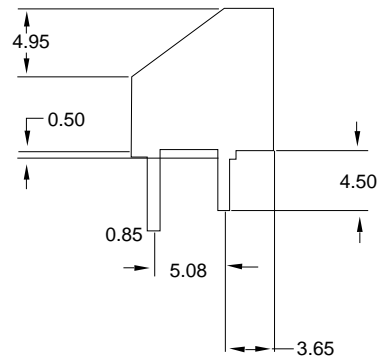

# PRODUCT INFORMATION

## ST-2A Package

## Emitter or Detector in ST® Package

Mitel emitters and detectors can be provided in this low-profile ST® package. The device is electrically isolated from the ST® receptacle to facilitate electrical connection. And optimum fiber-coupled power or responsivity is ensured by active alignment against the fiber.

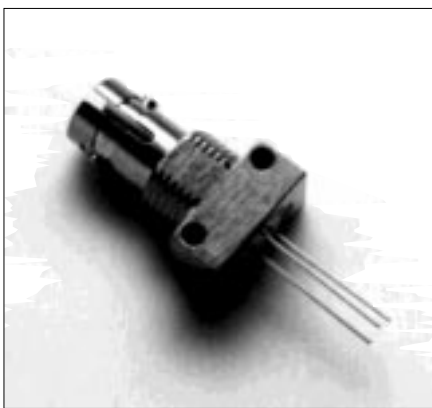

### Absolute Maximum Ratings

PARAMETER	SYMBOL	LIMIT
Operating & Storage Temperature ST-2A (Note 1)	$T_{stg}, T_{op}$	-40 to +85°C

Note 1: Temperature range can be extended to -55° to +125°C on request.

### Thermal Characteristics

PARAMETER	SYMBOL	MIN.	TYP.	MAX.	UNIT
Thermal Resistance - Infinite Heat Sink (Note 2)	$R_{thcc}$			40	°C/W
Thermal Resistance - No Heat Sink (Note 2)	$R_{thca}$			200	°C/W
Thermal Resistance - On PC Board (Note 2)	$R_{thca}$		80		°C/W

Note 2: Add  $R_{thjc}$  for emitter or detector to estimate the total thermal resistance.

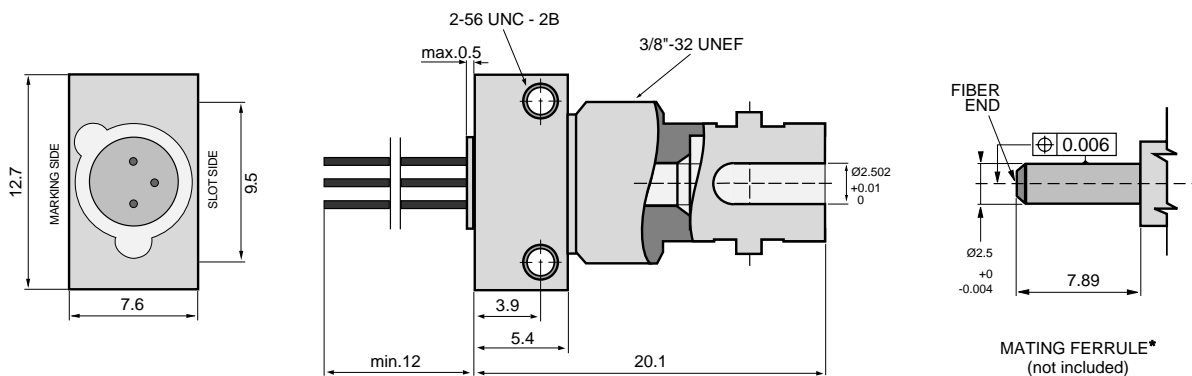

All Dimensions in mm

\*The fiber-coupled power/responsivity is guaranteed to meet the LED/PIN data sheet - provided a ferrule meeting this specification is used.

### Mechanical Outline of Diode in ST-2A Housing

(ST is a registered trademark of AT&T)

103326 1994-09-20



Europe: Tel (46) 8 58 02 45 00 Fax (46) 8 58 02 01 10  
Tel (44) 1291 436180 Fax (44) 1291 436771

America: Tel 1-800-96MITEL Fax (613) 592-6909  
Asia: Tel (65) 293 5312 Fax (65) 293 8527

# PRODUCT INFORMATION

## SMA-2A Package

## Emitter or Detector in SMA Package

Mitel emitters and detectors can be provided in this low-profile SMA package. The device is electrically isolated from the SMA receptacle to facilitate electrical connection. And optimum fiber-coupled power or responsivity is ensured by active alignment against the fiber.



### Absolute Maximum Ratings

PARAMETER	SYMBOL	LIMIT
Operating & Storage Temperature SMA-2A (Note 1)	$T_{stg}, T_{op}$	-40 to +85°C

Note 1: Temperature range can be extended to -55° to +125°C on request.

### Thermal Characteristics

PARAMETER	SYMBOL	MIN.	TYP.	MAX.	UNIT
Thermal Resistance - Infinite Heat Sink (Note 2)	$R_{thcc}$			40	°C/W
Thermal Resistance - No Heat Sink (Note 2)	$R_{thca}$			200	°C/W
Thermal Resistance - On PC Board (Note 2)	$R_{thca}$		80		°C/W

Note 2: Add  $R_{thjc}$  for emitter or detector to estimate the total thermal resistance.



All Dimensions in mm

\*The fiber-coupled power/responsivity is guaranteed to meet the LED/PIN data sheet - provided a ferrule meeting this specification is used.

### Mechanical Outline of Diode in SMA-2A Housing

103325 1994-09-20



Europe: Tel (46) 8 58 02 45 00 Fax (46) 8 58 02 01 10  
Tel (44) 1291 436180 Fax (44) 1291 436771

America: Tel 1-800-96MITEL Fax (613) 592-6909  
Asia: Tel (65) 293 5312 Fax (65) 293 8527

# PRODUCT INFORMATION

## SC-2A Package

## Emitter or Detector in SC Package

Mitel emitters and detectors can be provided in this low-profile SC package. The device is electrically isolated from the SC receptacle to facilitate electrical connection. And optimum fiber-coupled power or responsivity is ensured by active alignment against the fiber.

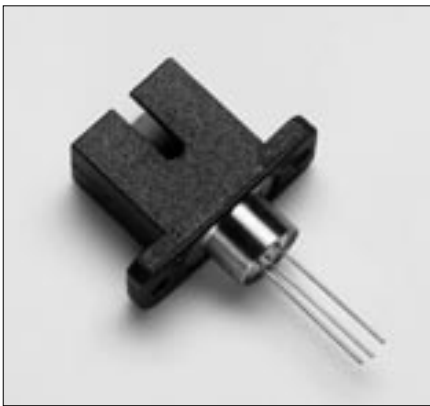

### Absolute Maximum Ratings

PARAMETER	SYMBOL	LIMIT
Operating & Storage Temperature	$T_{stg}, T_{op}$	-40 to +85°C

### Thermal Characteristics

PARAMETER	SYMBOL	MIN.	TYP.	MAX.	UNIT
Thermal Resistance - Infinite Heat Sink (Note 1)	$R_{thcc}$			40	°C/W
Thermal Resistance - No Heat Sink (Note 1)	$R_{thca}$			200	°C/W
Thermal Resistance - On PC Board (Note 1)	$R_{thca}$		125		°C/W

Note 1: Add  $R_{thjc}$  for emitter or detector to estimate the total thermal resistance.

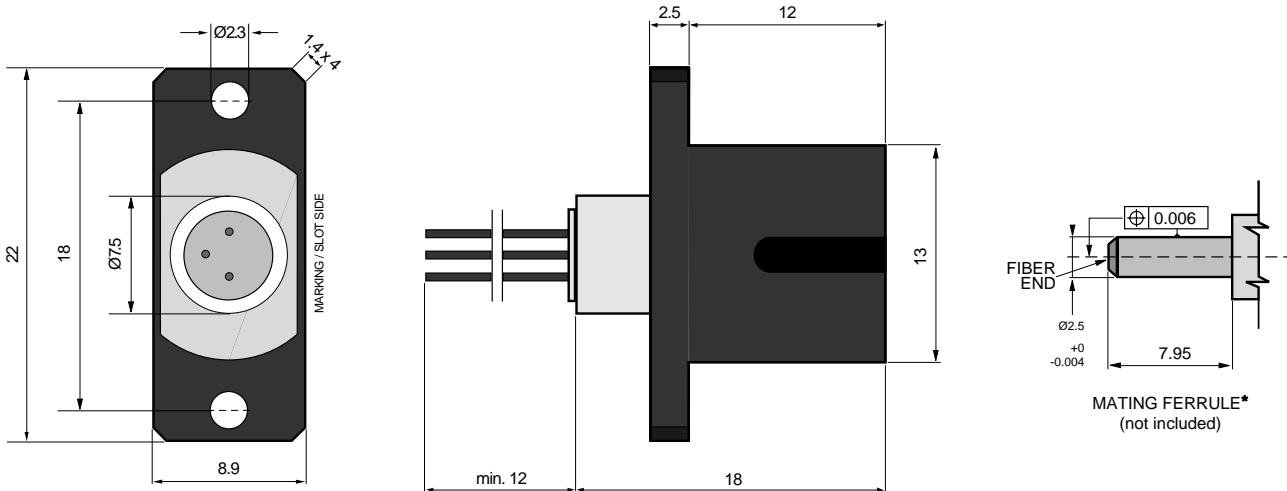

All Dimensions in mm

\* The fiber-coupled power/responsivity is guaranteed to meet the LED/PIN data sheet - provided a ferrule meeting this specification is used.

### Mechanical Outline of Diode in SC-2A Housing

105967 1994-09-20



Europe: Tel (46) 8 58 02 45 00 Fax (46) 8 58 02 01 10  
Tel (44) 1291 436180 Fax (44) 1291 436771

America: Tel 1-800-96MITEL Fax (613) 592-6909  
Asia: Tel (65) 293 5312 Fax (65) 293 8527

# PRODUCT INFORMATION

## Pigtail-3A Package

### Emitter or Detector in Pigtail Package

Mitel emitters and detectors can be provided in this pigtail package with a wide selection of fiber types. The device is electrically isolated from the pigtail receptacle to facilitate electrical connection. And optimum fiber-coupled power or responsivity is ensured by active alignment against the fiber. A special design maximizes the return loss for detectors in this package.



### Absolute Maximum Ratings

PARAMETER	SYMBOL	LIMIT
Operating & Storage Temperature (Note 1 & 2)	$T_{stg}, T_{op}$	-40 to +85°C

Note 1: Temperature range can be extended to -55/+125°C on request.

Note 2: Temperature range may be limited by the specification of the fiber.

### Thermal Characteristics

PARAMETER	SYMBOL	MIN.	TYP.	MAX.	UNIT
Thermal Resistance - Infinite Heat Sink (Note 3)	$R_{thcc}$			25	°C/W
Thermal Resistance - No Heat Sink (Note 3)	$R_{thca}$			250	°C/W
Thermal Resistance - On PC-Board (Note 3)	$R_{thca}$		120		°C/W

Note 3: Add  $R_{thjc}$  for LED to estimate the total thermal resistance.

### Optical Characteristics

PARAMETER	SYMBOL	MIN.	TYP.	MAX.	UNIT
Return Loss 10/125µm fiber (PIN only)	RL	40	55		dB

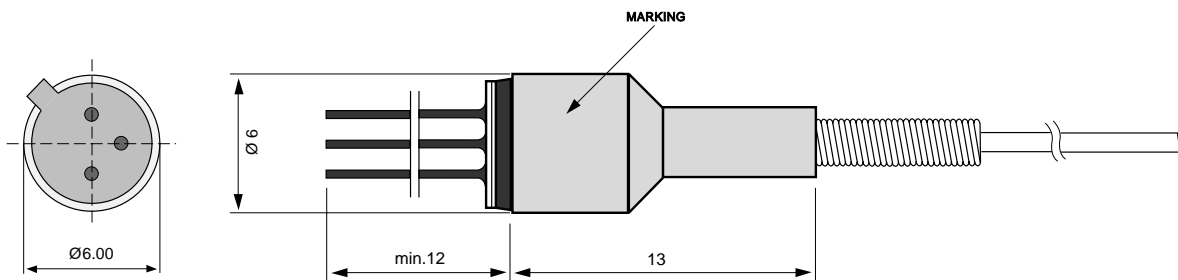

All Dimensions in mm

### Mechanical Outline of Diode in PIGTAIL-3A Housing

105429 1997-07-03



Europe: Tel (46) 8 58 02 45 00 Fax (46) 8 58 02 01 10  
Tel (44) 1291 436180 Fax (44) 1291 436771

America: Tel 1-800-96MITEL Fax (613) 592-6909  
Asia: Tel (65) 293 5312 Fax (65) 293 8527



# PRODUCT INFORMATION

## FC-2A Package

## Emitter or Detector in FC Package

Mitel emitters and detectors can be provided in this low-profile FC package. The device is electrically isolated from the FC receptacle to facilitate electrical connection. And optimum fiber-coupled power or responsivity is ensured by active alignment against the fiber.



### Absolute Maximum Ratings

PARAMETER	SYMBOL	LIMIT
Operating & Storage Temperature FC-2A (Note 1)	$T_{stg}, T_{op}$	-40 to +85°C

Note 1: Temperature range can be extended to -55° to +125°C on request.

### Thermal Characteristics

PARAMETER	SYMBOL	MIN.	TYP.	MAX.	UNIT
Thermal Resistance - Infinite Heat Sink (Note 2)	$R_{thcc}$			40	°C/W
Thermal Resistance - No Heat Sink (Note 2)	$R_{thca}$			200	°C/W
Thermal Resistance - On PC Board (Note 2)	$R_{thca}$		80		°C/W

Note 2: Add  $R_{thjc}$  for emitter or detector to estimate the total thermal resistance.

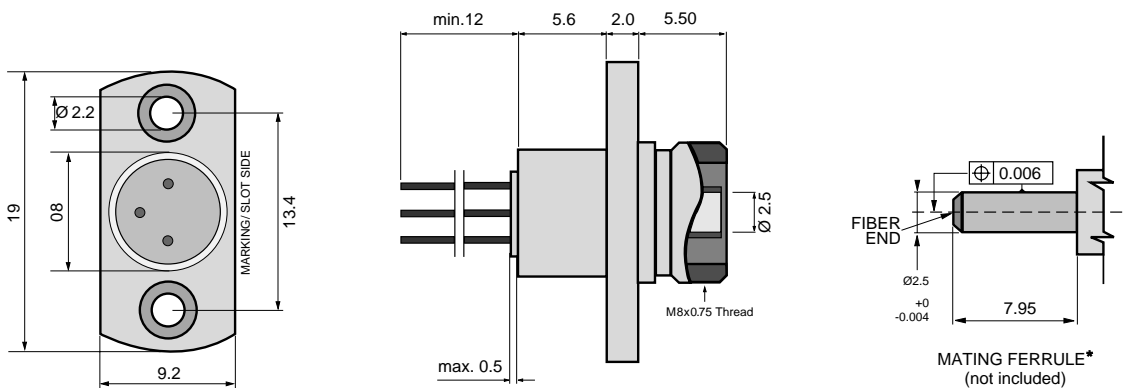

All Dimensions in mm

\* The fiber-coupled power/responsivity is guaranteed to meet the LED/PIN data sheet - provided a ferrule meeting this specification is used.

### Mechanical Outline of Diode in FC-2A Housing

105515 1994-09-20



Europe: Tel (46) 8 58 02 45 00 Fax (46) 8 58 02 01 10  
Tel (44) 1291 436180 Fax (44) 1291 436771

America: Tel 1-800-96MITEL Fax (613) 592-6909  
Asia: Tel (65) 293 5312 Fax (65) 293 8527



<http://www.mitelsemi.com>

**World Headquarters - Canada**

Tel: +1 (613) 592 2122  
Fax: +1 (613) 592 6909

**North America**

Tel: +1 (770) 486 0194  
Fax: +1 (770) 631 8213

**Asia/Pacific**

Tel: +65 333 6193  
Fax: +65 333 6192

**Europe, Middle East,  
and Africa (EMEA)**

Tel: +44 (0) 1793 518528  
Fax: +44 (0) 1793 518581

Information relating to products and services furnished herein by Mitel Corporation or its subsidiaries (collectively "Mitel") is believed to be reliable. However, Mitel assumes no liability for errors that may appear in this publication, or for liability otherwise arising from the application or use of any such information, product or service or for any infringement of patents or other intellectual property rights owned by third parties which may result from such application or use. Neither the supply of such information or purchase of product or service conveys any license, either express or implied, under patents or other intellectual property rights owned by Mitel or licensed from third parties by Mitel, whatsoever. Purchasers of products are also hereby notified that the use of product in certain ways or in combination with Mitel, or non-Mitel furnished goods or services may infringe patents or other intellectual property rights owned by Mitel.

This publication is issued to provide information only and (unless agreed by Mitel in writing) may not be used, applied or reproduced for any purpose nor form part of any order or contract nor to be regarded as a representation relating to the products or services concerned. The products, their specifications, services and other information appearing in this publication are subject to change by Mitel without notice. No warranty or guarantee express or implied is made regarding the capability, performance or suitability of any product or service. Information concerning possible methods of use is provided as a guide only and does not constitute any guarantee that such methods of use will be satisfactory in a specific piece of equipment. It is the user's responsibility to fully determine the performance and suitability of any equipment using such information and to ensure that any publication or data used is up to date and has not been superseded. Manufacturing does not necessarily include testing of all functions or parameters. These products are not suitable for use in any medical products whose failure to perform may result in significant injury or death to the user. All products and materials are sold and services provided subject to Mitel's conditions of sale which are available on request.

M Mitel (design) and ST-BUS are registered trademarks of MITEL Corporation  
Mitel Semiconductor is an ISO 9001 Registered Company  
Copyright 1999 MITEL Corporation  
All Rights Reserved  
Printed in CANADA

TECHNICAL DOCUMENTATION - NOT FOR RESALE