



## **SAW Components**

### **SAW filter**

Short range devices

<b>Series/type:</b>	<b>B3782</b>
<b>Ordering code:</b>	<b>B39431B3782Z810</b>
<b>Date:</b>	<b>December 13, 2006</b>
<b>Version:</b>	<b>2.0</b>



**Application**

- Low-loss RF filter for remote control receivers
- Balanced and unbalanced operation possible



**Features**

- Package size 3.8 x 3.8 x 1.5 mm<sup>3</sup>
- Package code QCC8B
- RoHS compatible
- Approximate weight 0.07 g
- Package for **Surface Mount Technology (SMT)**
- Ni, gold-plated terminals
- Lead free soldering compatible with J - STD20C
- Passivation layer Elpas
- AEC-Q200 qualified component family
- **Electrostatic Sensitive Device (ESD)**

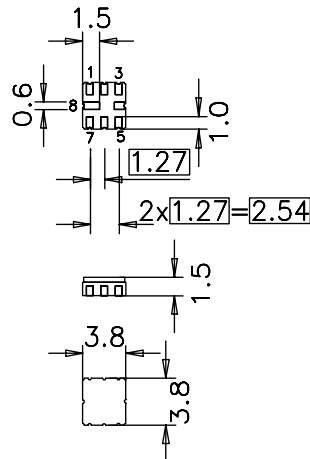

**Pin configuration<sup>1)</sup>**

- 1 Input ground (recommended) or input
- 2 Input (recommended) or input ground
- 5 Output (recommended) or output ground
- 6 Output ground (recommended) or output
- 4,8 Case - ground
- 3,7 To be grounded

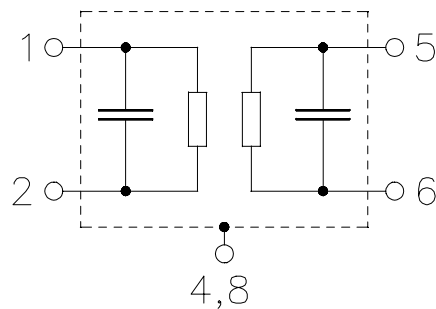

1) The recommended pin configuration usually offers best suppression of electrical crosstalk. The filter characteristics refer to this configuration.



**SAW Components**

**B3782**

**SAW filter**

**433.92 MHz**

**Data sheet**



**Characteristics**

Temperature range for specification:  $T = -40\text{ °C to }+105\text{ °C}$   
 Terminating source impedance:  $Z_S = 50\ \Omega$  and matching network  
 Terminating load impedance:  $Z_L = 50\ \Omega$  and matching network

		min.	typ. @ 25 °C	max.	
<b>Center frequency</b>	$f_C$	—	433.92	—	MHz
<b>Minimum insertion attenuation</b>	$\alpha_{min}$				
incl. loss in matching elements ( $Q_L = 46$ )		—	2.2	2.9	dB
excl. loss in matching elements		—	1.3	2.0	dB
<b>Pass band (relative to <math>\alpha_{min}</math>)</b>					
433.385 ... 434.455MHz		—	1.3	2.5	dB
433.370 ... 434.470MHz		—	1.4	3.0	dB
<b>Relative attenuation (relative to <math>\alpha_{min}</math>)</b>	$\alpha_{rel}$				
10.00 ... 390.00 MHz		50	55	—	dB
390.00 ... 425.00 MHz		45	50	—	dB
425.00 ... 430.00 MHz		29	33	—	dB
430.00 ... 432.80 MHz		18	23	—	dB
432.80 ... 433.00 MHz		7	14	—	dB
435.00 ... 435.40 MHz		8	12	—	dB
435.40 ... 441.50 MHz		15	19	—	dB
441.50 ... 450.00 MHz		35	40	—	dB
450.00 ... 550.00 MHz		48	53	—	dB
550.00 ... 1000.00 MHz		55	60	—	dB
1000.00 ... 2500.00 MHz		45	50	—	dB
<b>Impedance for pass band matching<sup>1)</sup></b>					
Input: $Z_{IN} = R_{IN} \parallel C_{IN}$		—	400    2.6	—	$\Omega \parallel \text{pF}$
Output: $Z_{OUT} = R_{OUT} \parallel C_{OUT}$		—	400    2.6	—	$\Omega \parallel \text{pF}$

1) Impedance for passband matching bases on an ideal, perfect matching of the SAW filter to source- and to load impedance (here 50 Ohm). After removal of the SAW filter the input impedance of the input and output matching network is calculated. The conjugate complex value of these characteristic impedances are the input and output impedances for flat passband. For more details we refer to EPCOS application note #4.

**Maximum ratings**

Operable temperature range	T	-45/+120	°C	
Storage temperature range	T <sub>stg</sub>	-45/+120	°C	
DC voltage	V <sub>DC</sub>	6	V	
Source power	P <sub>S</sub>	10	dBm	source impedance 50 $\Omega$

Please read *cautions and warnings and important notes* at the end of this document.



Matching network to 50  $\Omega$  (element values depend on pcb layout and equivalent circuit)

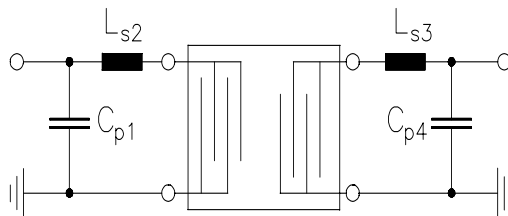

$$C_{p1} = 4.7 \text{ pF}$$

$$L_{s2} = 47 \text{ nH}$$

$$L_{s3} = 47 \text{ nH}$$

$$C_{p4} = 4.7 \text{ pF}$$

### Minimising the crosstalk

For a good ultimate rejection a low crosstalk is necessary. Low crosstalk can be realised with a good RF layout. The major crosstalk mechanism is caused by the “ground-loop” problem.

Grounding loops are created if input- and output transducer GND are connected on the top-side of the PCB and fed to the system grounding plane by a common via hole. To avoid the common ground path, the ground pin of the input- and output transducer are fed to the system ground plane (bottom PCB plane) by their own via hole. The transducers' grounding pins should be isolated from the upper grounding plane.

A common GND inductivity of 0.5nH degrades the ultimate rejection (crosstalk) by 20dB.

The optimised PCB layout, including matching network for transformation to 50 Ohm, is shown here. In this PCB layout the grounding loops are minimised to realise good ultimate rejection

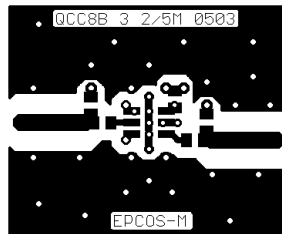

Optimised PCB layout for SAW filters in QCC8B package, pinning 2,5 (top side, scale 1:1)

The bottom side is a copper plane (system ground area). The input and output grounding pins are isolated and connected to the common ground by separated via holes.

For good contact of the upper grounding area with the lower side it is necessary to place enough via holes.



Transfer function

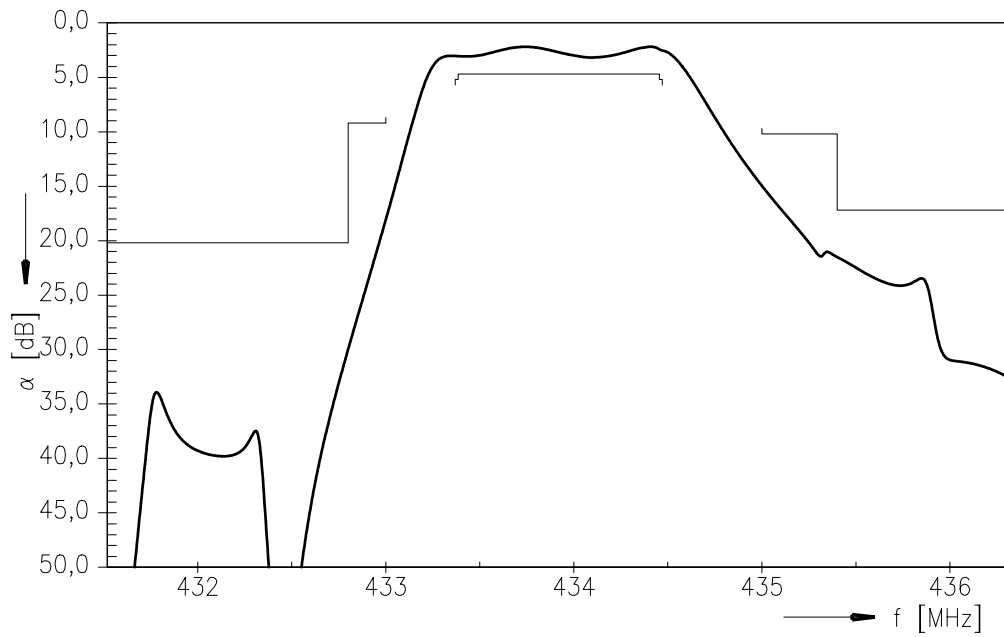

Transfer function (wideband)

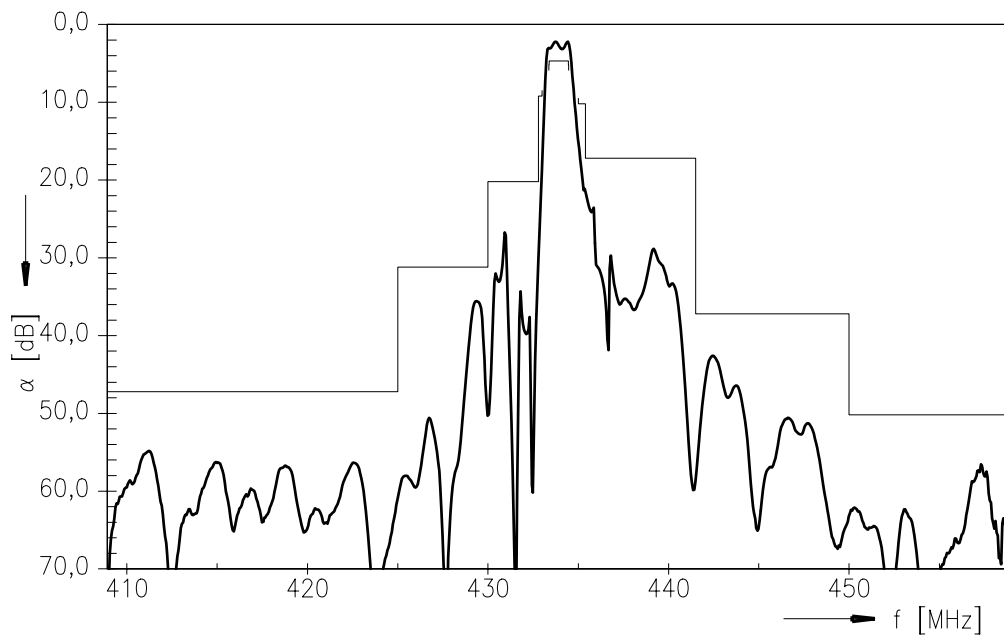

Important notes

Transfer function (ultimate rejection)

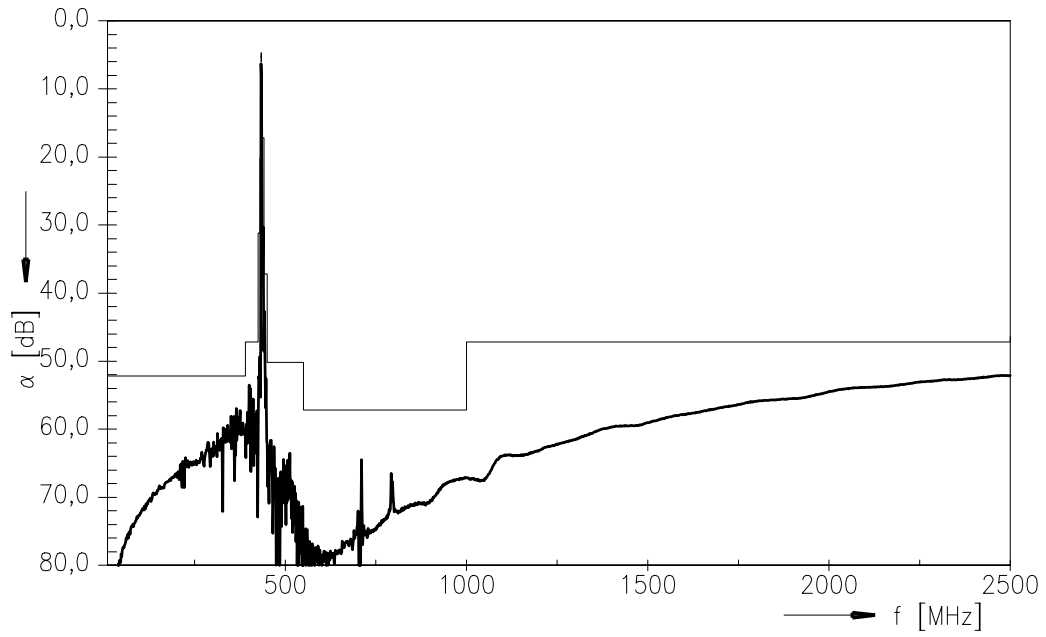



SAW Components

B3782

SAW filter

433.92 MHz

Data sheet



## References

Type	B3782
Ordering code	B39431B3782Z810
Marking and package	C61157-A7-A46
Packaging	F61074-V8167-Z000
Date codes	L_1126
S-parameters	B3782_SB.s2p B3782_WB.s2p
Soldering profile	S_6001
RoHS compatible	defined as compatible with the following documents: "DIRECTIVE 2002/95/EC OF THE EUROPEAN PARLIAMENT AND OF THE COUNCIL of 27 January 2003 on the restriction of the use of certain hazardous substances in electrical and electronic equipment. 2005/618/EC from April 18th, 2005, amending Directive 2002/95/EC of the European Parliament and of the Council for the purposes of establishing the maximum concentration values for certain hazardous substances in electrical and electronic equipment."

For further information please contact your local EPCOS sales office or visit our webpage at [www.epcos.com](http://www.epcos.com).

Published by EPCOS AG  
Surface Acoustic Wave Components Division  
P.O. Box 80 17 09, 81617 Munich, GERMANY

© EPCOS AG 2006. This brochure replaces the previous edition.

For questions on technology, prices and delivery please contact the Sales Offices of EPCOS AG or the international Representatives.

Due to technical requirements components may contain dangerous substances. For information on the type in question please also contact one of our Sales Offices.

Please read *cautions and warnings and important notes* at the end of this document.



## Important notes

The following applies to all products named in this publication:

1. Some parts of this publication contain **statements about the suitability of our products for certain areas of application**. These statements are based on our knowledge of typical requirements that are often placed on our products in the areas of application concerned. We nevertheless expressly point out **that such statements cannot be regarded as binding statements about the suitability of our products for a particular customer application**. As a rule, EPCOS is either unfamiliar with individual customer applications or less familiar with them than the customers themselves. For these reasons, it is always ultimately incumbent on the customer to check and decide whether an EPCOS product with the properties described in the product specification is suitable for use in a particular customer application.
2. We also point out that **in individual cases, a malfunction of passive electronic components or failure before the end of their usual service life cannot be completely ruled out in the current state of the art, even if they are operated as specified**. In customer applications requiring a very high level of operational safety and especially in customer applications in which the malfunction or failure of a passive electronic component could endanger human life or health (e.g. in accident prevention or life-saving systems), it must therefore be ensured by means of suitable design of the customer application or other action taken by the customer (e.g. installation of protective circuitry or redundancy) that no injury or damage is sustained by third parties in the event of malfunction or failure of a passive electronic component.
3. The warnings, cautions and product-specific notes must be observed.
4. In order to satisfy certain technical requirements, **some of the products described in this publication may contain substances subject to restrictions in certain jurisdictions (e.g. because they are classed as "hazardous")**. Useful information on this will be found in our Material Data Sheets on the Internet ([www.epcos.com/material](http://www.epcos.com/material)). Should you have any more detailed questions, please contact our sales offices.
5. We constantly strive to improve our products. Consequently, **the products described in this publication may change from time to time**. The same is true of the corresponding product specifications. Please check therefore to what extent product descriptions and specifications contained in this publication are still applicable before or when you place an order. We also **reserve the right to discontinue production and delivery of products**. Consequently, we cannot guarantee that all products named in this publication will always be available.
6. Unless otherwise agreed in individual contracts, **all orders are subject to the current version of the "General Terms of Delivery for Products and Services in the Electrical Industry" published by the German Electrical and Electronics Industry Association (ZVEI)**.
7. The trade names EPCOS, CeraDiode, CSSP, PhaseCap, PhaseMod, SIFI, SIKOREL, Silver-Cap, SIMID, SIOV, SIP5D, SIP5K, TOPcap, UltraCap, WindCap are **trademarks registered or pending** in Europe and in other countries. Further information will be found on the Internet at [www.epcos.com/trademarks](http://www.epcos.com/trademarks).