

PCA2002

32 kHz watch circuit with programmable output period and pulse width

Rev. 05 — 11 November 2008

Product data sheet

1. General description

The PCA2002 is a CMOS integrated circuit for battery operated wrist watches with a 32 kHz quartz crystal as the timing element and a bipolar stepping motor. The quartz crystal oscillator and the frequency divider are optimized for minimum current consumption. A timing accuracy of 1 ppm is achieved with a programmable, digital frequency adjustment.

The output period and the output pulse width can be programmed. It can be selected between a full output pulse or a chopped output pulse with a duty cycle of 75 %. In addition, a stretching pulse can be added to the primary driving pulse.

A pad RESET is provided (used for stopping the motor) for accurate time setting and for accelerated testing of the watch.

2. Features

- Amplitude-regulated 32 kHz quartz crystal oscillator, with excellent frequency stability and high immunity to leakage currents
- Electrically programmable time calibration with 1 ppm resolution stored in One Time Programmable (OTP) memory
- The quartz crystal is the only external component required
- Very low current consumption: typically 90 nA
- Output pulses for bipolar stepping motors
- Five different programmable output periods (1 s to 30 s)
- Output pulse width programmable between 1 ms and 8 ms
- Full or chopped motor pulse and pulse stretching, selectable
- Stop function for accurate time setting and current saving during shelf life
- Test mode for accelerated testing of the mechanical parts of the watch
- Test bits for type recognition

3. Applications

- Driver circuits for bipolar stepping motors
- High immunity motor drive circuits
- High production volumes

4. Ordering information

Table 1. Ordering information

Type number	Package			
	Name	Description	Delivery form	Version
PCA2002U/AB/1	PCA200xU	wire bond die; 8 bonding pads; 1.16 × 0.86 × 0.22 mm	bare die; chip in tray	PCA200xU
PCA2002U/10AB/1	PCA200xU	wire bond die; 8 bonding pads; 1.16 × 0.86 × 0.22 mm	bare die; chip on film frame carrier	PCA200xU
PCA2002CX8/5/1	PCA200xCX	wafer level chip-size package; 8 bumps; 1.16 × 0.86 × 0.31 mm	unsawn wafer with lead free solder bumps	PCA200xCX

5. Block diagram

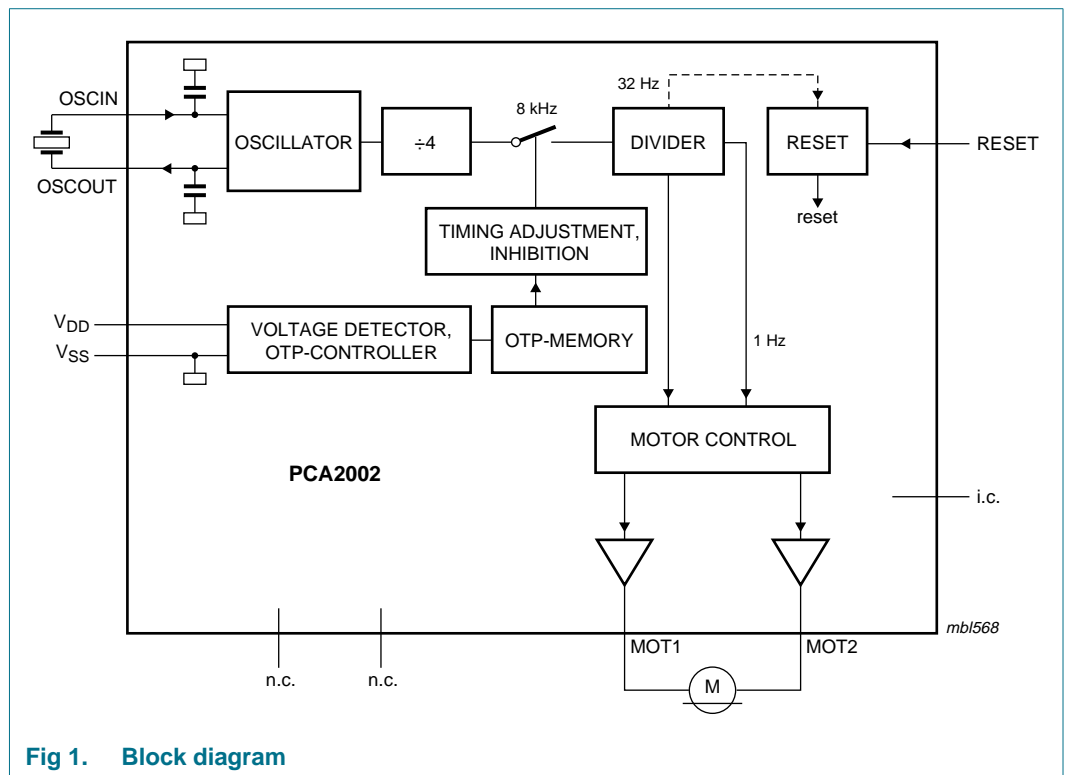

6. Pinning information

6.1 Pinning

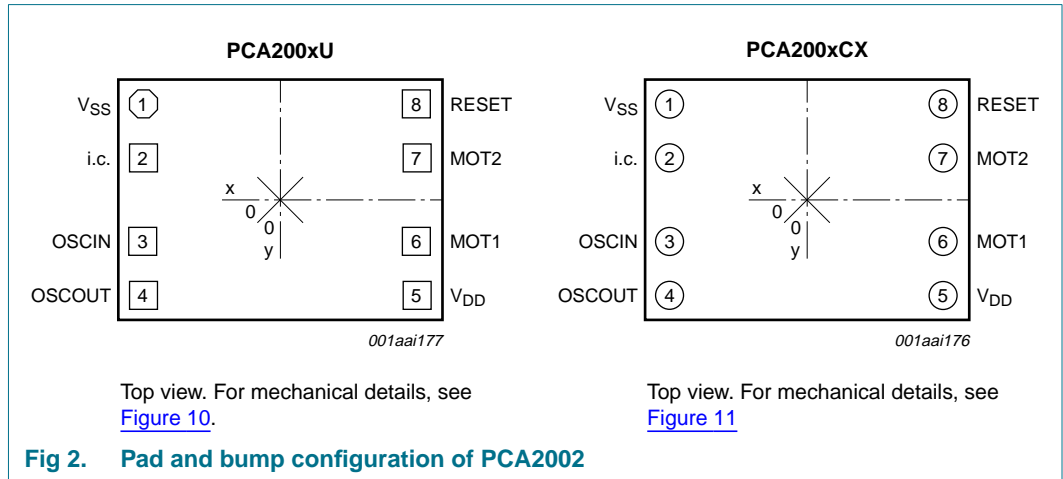

6.2 Pin description

Table 2. Pin description for PCA2002

Symbol	Pin	Description
V _{SS}	1	ground
i.c.	2	internally connected
OSCIN	3	oscillator input
OSCOUT	4	oscillator output
V _{DD}	5	supply voltage
MOT1	6	motor 1 output
MOT2	7	motor 2 output
RESET	8	reset input

7. Functional description

7.1 Motor pulse

The motor driver delivers pulses with an alternating polarity. The output waveform across the motor terminals is illustrated in [Figure 3](#). Between the motor pulses, both terminals are connected to V_{DD} which means that the motor is short-circuit.

The following parameters can be selected and are stored in a One Time Programmable (OTP) memory:

- Output periods of 1 s, 5 s, 10 s, 20 s and 30 s
- Pulse width (t_p) between 0.98 ms and 7.8 ms in steps of 0.98 ms
- Full or chopped (75 %) output pulse
- Pulse stretching: an enlargement pulse is added to the primary motor pulse. This enlargement pulse has a duty cycle of 25 % and a width which is twice the programmed motor pulse width.

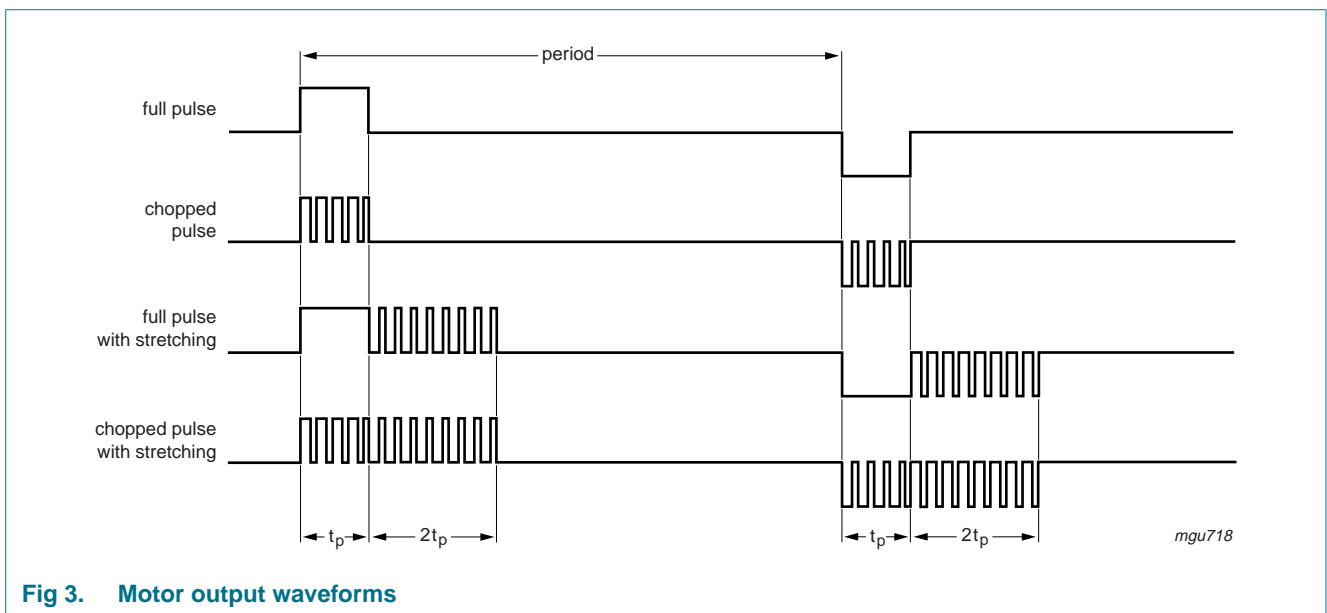

Fig 3. Motor output waveforms

7.2 Time calibration

The quartz crystal oscillator has an integrated capacitance of 5.2 pF, which is lower than the specified capacitance (C_L) of 8.2 pF for the quartz crystal (see [Table 9](#)). Therefore, the oscillator frequency is typically 60 ppm higher than 32.768 kHz. This positive frequency offset is compensated by removing the appropriate number of 8 192 Hz pulses in the divider chain (maximum 127 pulses), every 1 or 2 minutes. The time correction is given in [Table 3](#).

Table 3. Time calibration

Calibration period	Correction per step (n = 1)		Correction per step (n = 127)	
	ppm	seconds per day	ppm	seconds per day
1 minute	2.03	0.176	258	22.3
2 minutes	1.017	0.088	129	11.15

After measuring the effective oscillator frequency, the number of correction pulses must be calculated and stored together with the calibration period in the OTP memory (see [Section 7.6](#)).

The oscillator frequency can be measured at pad RESET, where a square wave signal with the frequency of $\frac{1}{1024} \times f_{osc}$ is provided.

This frequency shows a jitter every minute or every two minutes, depending on the programmed calibration period, which originates from the time calibration.

Details on how to measure the oscillator frequency and the programmed inhibition time are given in [Section 7.10](#).

7.3 Reset

At pin RESET an output signal with a frequency of $\frac{1}{1024} \times f_{osc} = 32Hz$ is provided.

Connecting pin RESET to V_{DD} stops the motor drive and opens the motor switches.

After releasing pin RESET, the first motor pulse is generated exactly one period later with the opposite polarity to the last pulse before stopping. The debounce time for the reset function is between 31 ms and 62 ms.

Connecting pin RESET to V_{SS} activates the test mode. In this mode the motor output frequency is 32 Hz, which can be used to test the mechanical function of the watch.

7.4 Programming possibilities

The programming data is organized in an array of 8-bit words (see [Table 4](#)). A contains the time calibration, B the setting for the monitor pulses, C is not used and D contains the type recognition (see [Table 7](#)).

Table 4. Words and bits

Word	Bit							
	1	2	3	4	5	6	7	8
A	number of 8192 Hz pulses to be removed							calibration period
B	pulse width			output period			duty cycle	pulse stretching
C								
D	type				factory test bit			

Table 5. Description of word A bits

Bit	Value	Description
Inhibit time		
1 to 7	-	adjust the number of the 8192 Hz pulses to be removed; bit 1 is the MSB and bit 7 is the LSB
Calibration period		
8	0	1 minute
	1	2 minutes

Table 6. Description of word B bits

Bit	Value	Description
Pulse width t_p (ms)		
1 to 3	000	0.98
	001	1.95
	010	2.9
	011	3.9
	100	4.9
	101	5.9
	110	6.8
	111	7.8
Output period (s)		
4 to 6	000	1
	001	5
	010	10
	011	20
	100	30
Duty cycle of motor pulse		
7	0	75 %
	1	100 %
Pulse stretching		
8	0	no pulse stretching
	1	a pulse width of $2 \times t_p$ and a duty factor of 25 % are added

7.5 Type recognition

Byte D is read to determine which type of the PCA200x family is used in a particular application.

Table 7. Description of word D bits

Bit	Value	Description
Type recognition		
1 to 4	0000	PCA2002
	1000	PCA2000
	0100	PCA2001
	1100	PCA2003

7.6 Programming procedure

To ensure that the oscillator starts up correctly you must execute a reset sequence (see [Figure 4](#)).

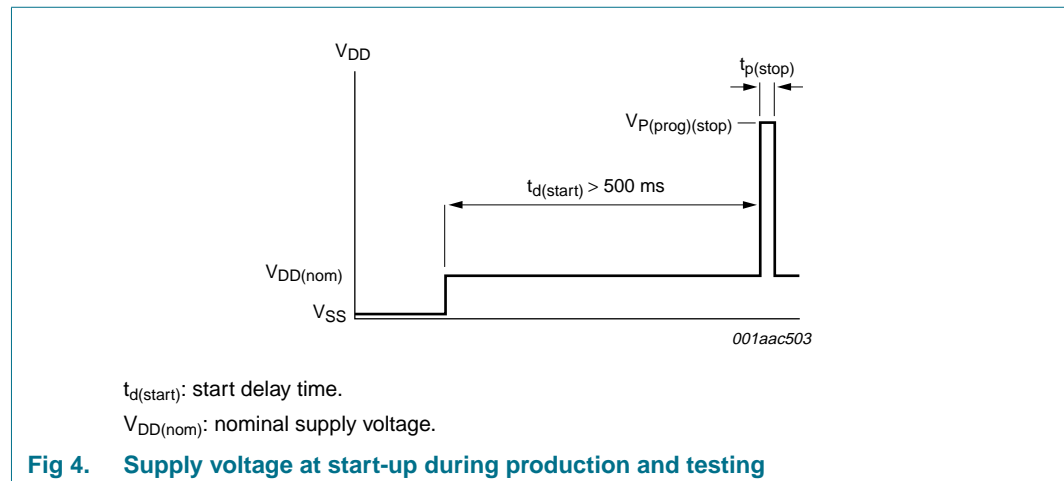

For a watch it is essential that the timing calibration can be made after the watch is fully assembled. In this situation, the supply pins are often the only terminals which are still accessible.

Writing to the OTP cells and performing the related functional checks is achieved in the PCA2002 by modulating the supply voltage. The necessary control circuit consists basically of a voltage level detector, an instruction counter which determines the function to be performed, and an 8-bit shift register which allows writing the OTP cells of an 8-bit word in one step and which acts as data pointer for checking the OTP content.

- State 1; measurement of the crystal oscillator frequency (divided by 1024)
- State 2; measurement of the inhibition time
- State 3; write/check word A
- State 4; write/check word B
- State 5; check word C (don't care since no meaning)
- State 6; check word D (type recognition)

Each instruction state is switched on with a pulse to $V_{P(prog)(start)}$. After this large pulse, an initial waiting time of t_0 is required. The programming instructions are then entered by modulating the supply voltage with small pulses (amplitude $V_{P(mod)}$ and pulse width t_{mod}). The first small pulse defines the start time, the following pulses perform three different functions, depending on the time delay (t_d) from the preceding pulse (see [Figure 5](#), [Figure 6](#), [Figure 7](#), [Figure 8](#) and [Figure 9](#)):

- $t_d = t_1$ (0.7 ms); increments the instruction counter
- $t_d = t_2$ (1.7 ms); clocks the shift register with data = logic 0
- $t_d = t_3$ (2.7 ms); clocks the shift register with data = logic 1

The programming procedure requires a stable oscillator, which means that a waiting time, determined by the start-up time of the oscillator, is necessary after power-up of the circuit.

After the $V_{P(prog)(start)}$ pulse, the instruction counter is in state 1 and the data shift register is cleared.

The instruction state ends with a second pulse to $V_{P(prog)(stop)}$ or with the pulse to V_{store} .

In any case, the instruction states are terminated automatically 2 seconds after the last supply modulation pulse.

7.7 Programming the memory cells

Applying the two-stage programming pulse (see [Figure 5](#)) transfers the stored data in the shift register to the OTP cells.

Perform the following to program a memory word:

1. Starting with a $V_{P(prog)(start)}$ pulse, wait for the time period t_0 then set the instruction counter to the word to be written ($t_d = t_1$).
2. Enter the data to be stored into the shift register ($t_d = t_2$ or t_3), LSB first (bit 8) and MSB last (bit 1).
3. Applying the two-stage programming pulse $V_{prestore}$ followed by V_{store} stores the word. The delay between the last data bit and the pre-store pulse $V_{prestore}$ is $t_d = t_4$. Store the word by raising the supply voltage to V_{store} ; the delay between the last data bit and the store pulse is t_d .

The example shown in [Figure 5](#) performs the following functions:

- Start
- Setting the instruction counter to state 4 (word B)
- Entering data word 110101 into the shift register (sequence: LSB first and MSB last)
- Writing the OTP cells for word B

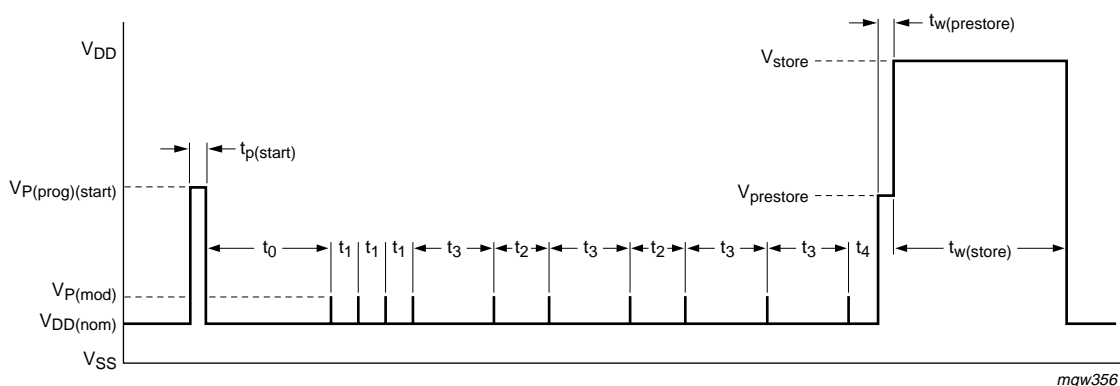

The example shows the programming of B = 110101 (the sequence is MSB first and LSB last).
 $V_{DD(nom)}$: nominal supply voltage.

Fig 5. Supply voltage modulation for programming

7.8 Checking the memory content

The stored data of the OTP array can be checked bit wise by measuring the supply current (see [Figure 6](#)). The array word is selected by the instruction state and the bit is addressed by the shift register.

To read a word, the word is first selected ($t_d = t_1$) and a logic 1 is written into the first cell of the shift register ($t_d = t_3$). This logic 1 is then shifted through the entire shift register ($t_d = t_2$), so that it points with each clock pulse to the next bit.

If the addressed OTP cell contains a logic 1, a 30 kΩ resistor is connected between V_{DD} and V_{SS} ; this increases the supply current accordingly.

[Figure 6](#) shows the supply voltage modulation for reading word B, with the corresponding supply current variation for word B = 110101 (sequence: first MSB and last LSB).

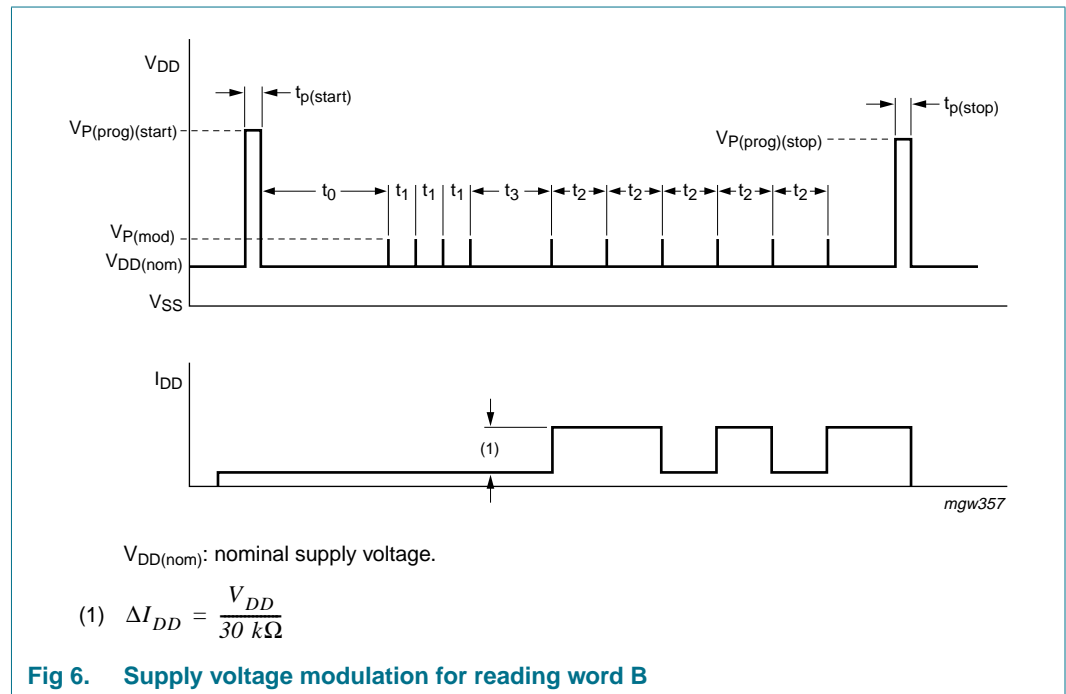

7.9 Frequency tuning at assembled watch

Figure 7 shows the test set-up for frequency tuning the assembled watch.

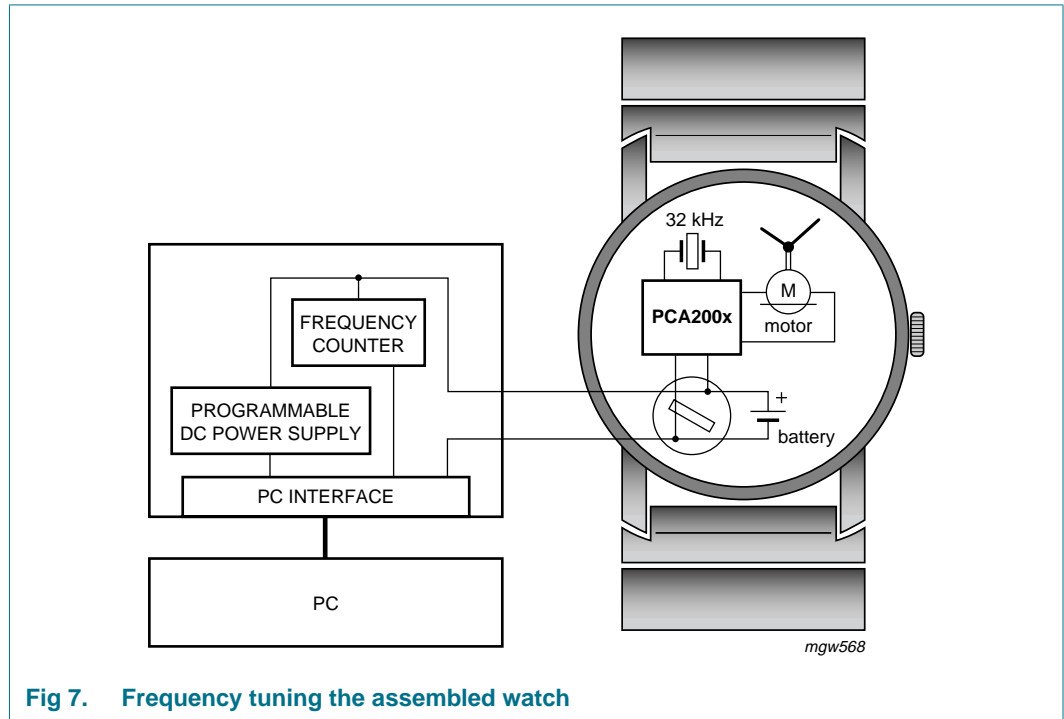

Fig 7. Frequency tuning the assembled watch

7.10 Measurement of the oscillator frequency and the inhibition time

The output of the two measuring states can either be monitored directly at pin RESET or as a modulation of the supply current (a modulating resistor of 30 kΩ is connected between V_{DD} and V_{SS} when the signal at pin RESET is at HIGH-level).

The supply voltage modulation must be followed as shown in Figure 4 in order to guarantee the correct start-up of the circuit during production and testing.

Measuring states:

- State 1; quartz crystal oscillator frequency divided by 1024; state 1 starts with a pulse to V_P and ends with a second pulse to V_P
- State 2; inhibition time has a value of n × 0.122 ms. A signal with the periodicity of 31.25 ms + n × 0.122 ms appears at pin RESET and as current modulation at pin V_{DD} (see Figure 8 and Figure 9)

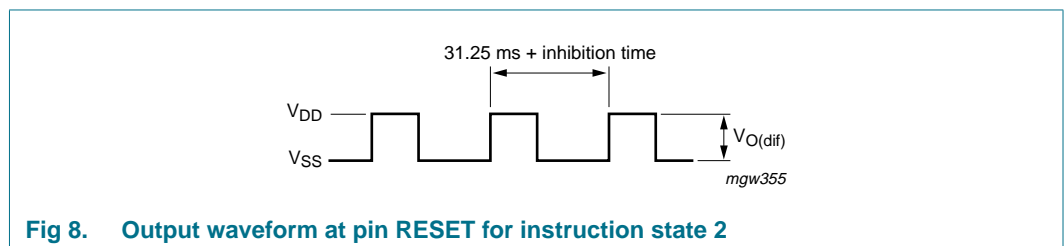
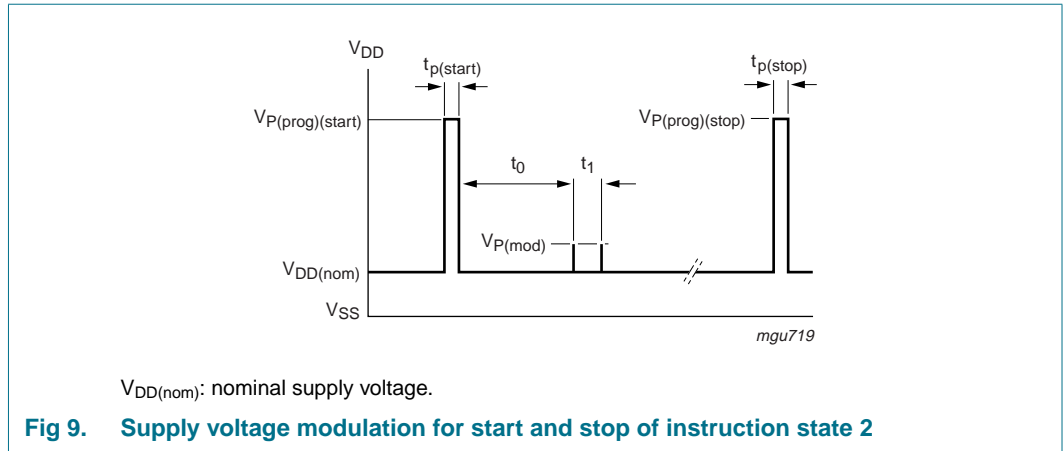

Fig 8. Output waveform at pin RESET for instruction state 2



8. Limiting values

Table 8. Limiting values

In accordance with the Absolute Maximum Rating System (IEC 60134).

Symbol	Parameter	Conditions	Min	Max	Unit
V_{DD}	supply voltage	$V_{SS} = 0\text{ V}$	[1][2] -1.8	+7.0	V
V_I	input voltage		-0.5	+7.5	V
t_{sc}	short circuit duration time	output	-	indefinite	s
T_{amb}	ambient temperature		-10	+60	°C
T_{stg}	storage temperature		-30	+100	°C
V_{esd}	electrostatic discharge voltage	HBM	[3] -	±2000	V
		MM	[4] -	±200	V
I_{lu}	latch-up current		[5] -	100	mA

- [1] When writing to the OTP cells, the supply voltage (V_{DD}) can be raised to a maximum of 12 V for a time period of 1 s.
- [2] Connecting the battery with reversed polarity does not destroy the circuit, but in this condition a large current flows which rapidly discharges the battery.
- [3] Pass level; Human Body Model (HBM) according to JESD22-A114.
- [4] Pass level; Machine Model (MM), according to JESD22-A115.
- [5] Pass level; Latch-up testing, according to JESD78.

9. Characteristics

Table 9. Characteristics

$V_{DD} = 1.55\text{ V}$; $V_{SS} = 0\text{ V}$; $f_{osc} = 32.768\text{ kHz}$; $T_{amb} = 25\text{ °C}$; quartz crystal: $R_s = 40\text{ k}\Omega$, $C_1 = 2\text{ fF}$ to 3 fF , $C_L = 8.2\text{ pF}$; unless otherwise specified.

Symbol	Parameter	Conditions	Min	Typ	Max	Unit
Supplies						
V_{DD}	supply voltage	normal operating mode; $T_{amb} = -10\text{ °C}$ to $+60\text{ °C}$	1.1	1.55	3.6	V
ΔV_{DD}	supply voltage variation	$\Delta V/\Delta t = 1\text{ V}/\mu\text{s}$	-	-	0.25	V
I_{DD}	supply current	between motor pulses	-	90	120	nA
		between motor pulses at $V_{DD} = 3.5\text{ V}$	-	120	180	nA
		$T_{amb} = -10\text{ °C}$ to $+60\text{ °C}$	-	-	200	nA
		stop mode; pin RESET connected to V_{DD}	-	100	135	nA
Motor output						
V_{sat}	saturation voltage	$R_{motor} = 2\text{ k}\Omega$; $T_{amb} = -10\text{ °C}$ to $+60\text{ °C}$	-	150	200	mV
$Z_{o(sc)}$	output impedance (short circuit)	between motor pulses; $I_{motor} < 1\text{ mA}$	-	200	300	Ω
Oscillator						
V_{start}	start voltage		1.1	-	-	V
g_m	transconductance	$V_{i(osc)} \leq 50\text{ mV(p-p)}$	5	10	-	μS
$t_{startup}$	start-up time		-	0.3	0.9	s
$\Delta f/f$	frequency stability	$\Delta V_{DD} = 100\text{ mV}$	-	0.05	0.2	ppm
$C_{L(itg)}$	integrated load capacitance		4.3	5.2	6.3	pF
R_{par}	parasitic resistance	allowed resistance between adjacent pins	20	-	-	$\text{M}\Omega$
Pad RESET						
f_o	output frequency		-	32	-	Hz
$V_{O(dif)}$	differential output voltage	$R_L = 1\text{ M}\Omega$; $C_L = 10\text{ pF}$	[1] 1.4	-	-	V
t_r	rise time	$R_L = 1\text{ M}\Omega$; $C_L = 10\text{ pF}$	[1] -	1	-	μs
t_f	fall time	$R_L = 1\text{ M}\Omega$; $C_L = 10\text{ pF}$	[1] -	1	-	μs
$I_{i(AV)}$	average input current	pin RESET connected to V_{DD} or V_{SS}	-	10	20	nA

[1] R_L and C_L are a load resistor and load capacitor, externally connected to pad RESET.

10. OTP programming characteristics

Table 10. Specifications for OTP programming

Symbol	Parameter ^[1]	Conditions	Min	Typ	Max	Unit
V_{DD}	supply voltage	during programming procedure	1.5	-	3.0	V
$V_{P(prog)(start)}$	programming supply voltage (start)		6.6	-	6.8	V
$V_{P(prog)(stop)}$	programming supply voltage (stop)		6.2	-	6.4	V
$V_{P(mod)}$	supply voltage modulation	for entering instructions	320	350	380	mV
$V_{prestore}$	prestore voltage	for prestore pulse	6.2	-	6.4	V
V_{store}	supply voltage	for writing to the OTP cells	9.9	10.0	10.1	V
I_{store}	store current	for writing to the OTP cells	-	-	10	mA
$t_{p(start)}$	start pulse width		8	10	12	ms
$t_{p(stop)}$	pulse width of stop pulse		0.05	-	0.5	ms
t_{mod}	modulation pulse width		25	30	40	μ s
$t_{w(prestore)}$	prestore pulse width		0.05	-	0.5	ms
$t_{w(store)}$	store pulse width	for writing to the OTP cells	95	100	110	ms
t_0	time 0	waiting time after start pulse	20	-	30	ms
t_1	time 1	pulse distance for incrementing the state counter	0.6	0.7	0.8	ms
t_2	time 2	pulse distance for clocking the data register with data = logic 0	1.6	1.7	1.8	ms
t_3	time 3	pulse distance for clocking the data register with data = logic 1	2.6	2.7	2.8	ms
t_4	time 4	waiting time for writing to OTP cells	0.1	0.2	0.3	ms
SR	slew rate	for modulation of the supply voltage	0.5	-	5.0	V/ μ s
R_{mod}	modulation resistance	supply current modulation read-out resistor	18	30	45	k Ω

[1] Program each word once only.

11. Bare die outline

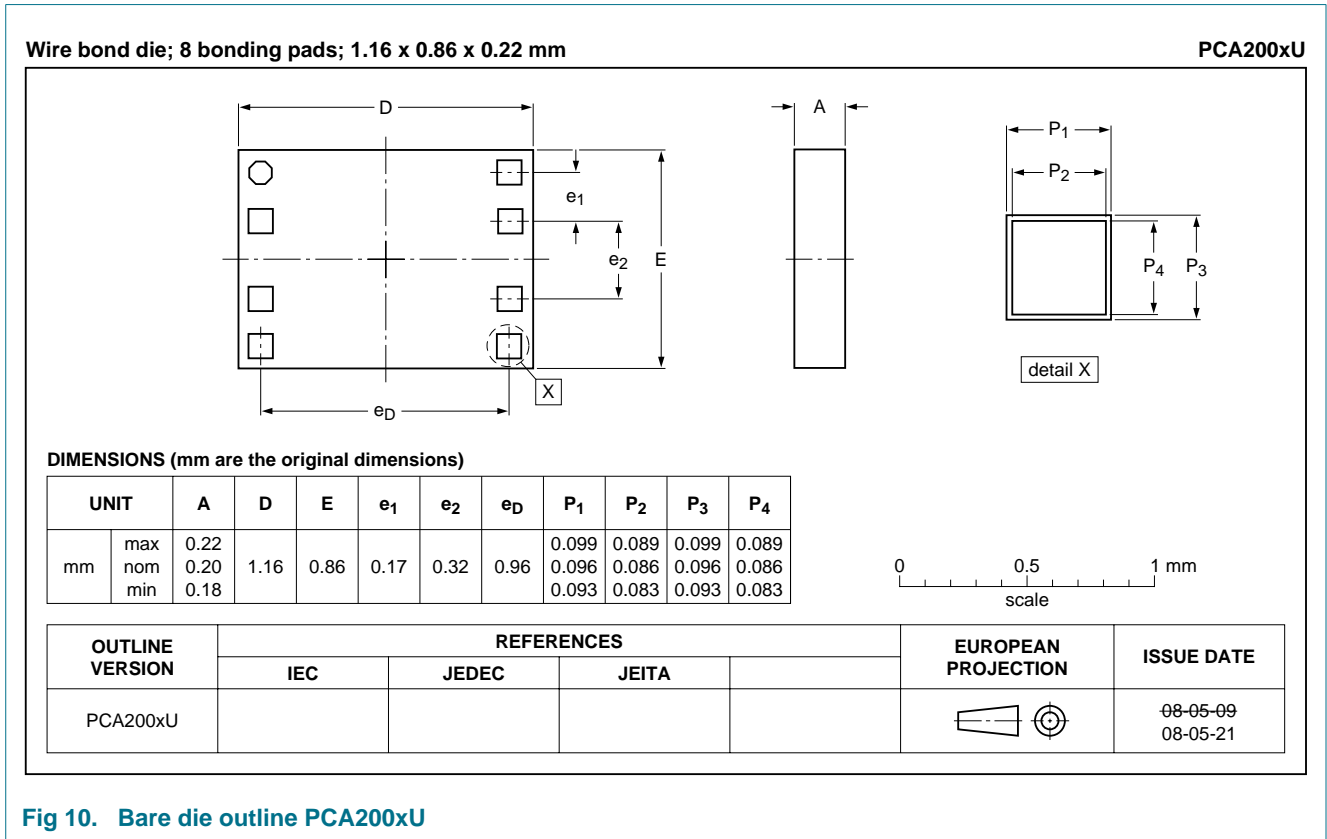

Fig 10. Bare die outline PCA200xU

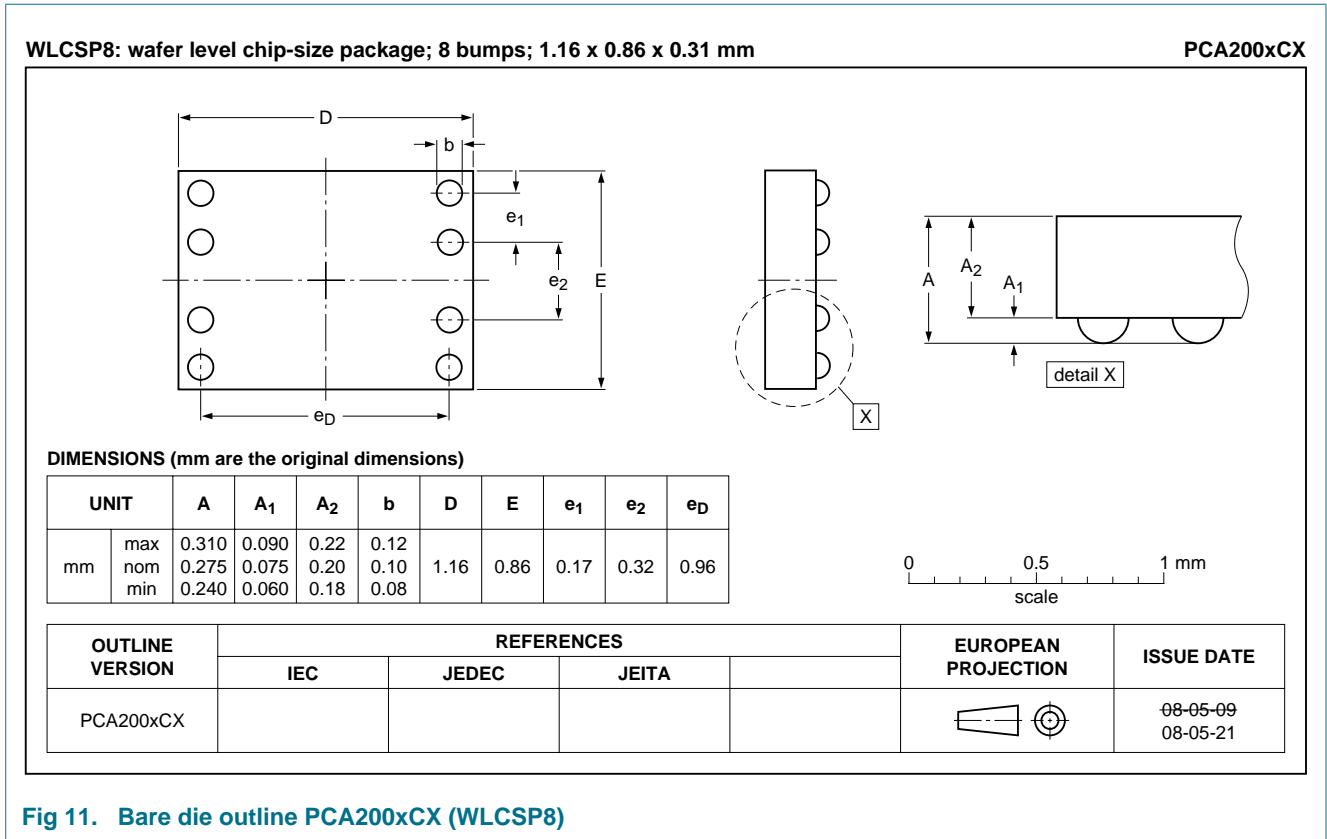

Fig 11. Bare die outline PCA200xCX (WLCSP8)

Table 11. Bonding pad and solder bump locations

Symbol	Pad	Coordinates ^[1]	
		x	y
V _{SS} ^[2]	1	-480	+330
i.c. ^[3]	2	-480	+160
OSCIN	3	-480	-160
OSCOU	4	-480	-330
V _{DD}	5	+480	-330
MOT1	6	+480	-160
MOT2	7	+480	+160
RESET	8	+480	+330

[1] All coordinates are referenced, in μm , to the center of the die (see Figure 10 and Figure 11).

[2] The substrate (rear side of the chip) is connected to V_{SS}. Therefore, the die pad must be either floating or connected to V_{SS}.

[3] Pad i.c. is used for factory test; in normal operation it must be left open-circuit, and it has an internal pull-down resistor connected to V_{SS}.

12. Packing information

12.1 Tray information

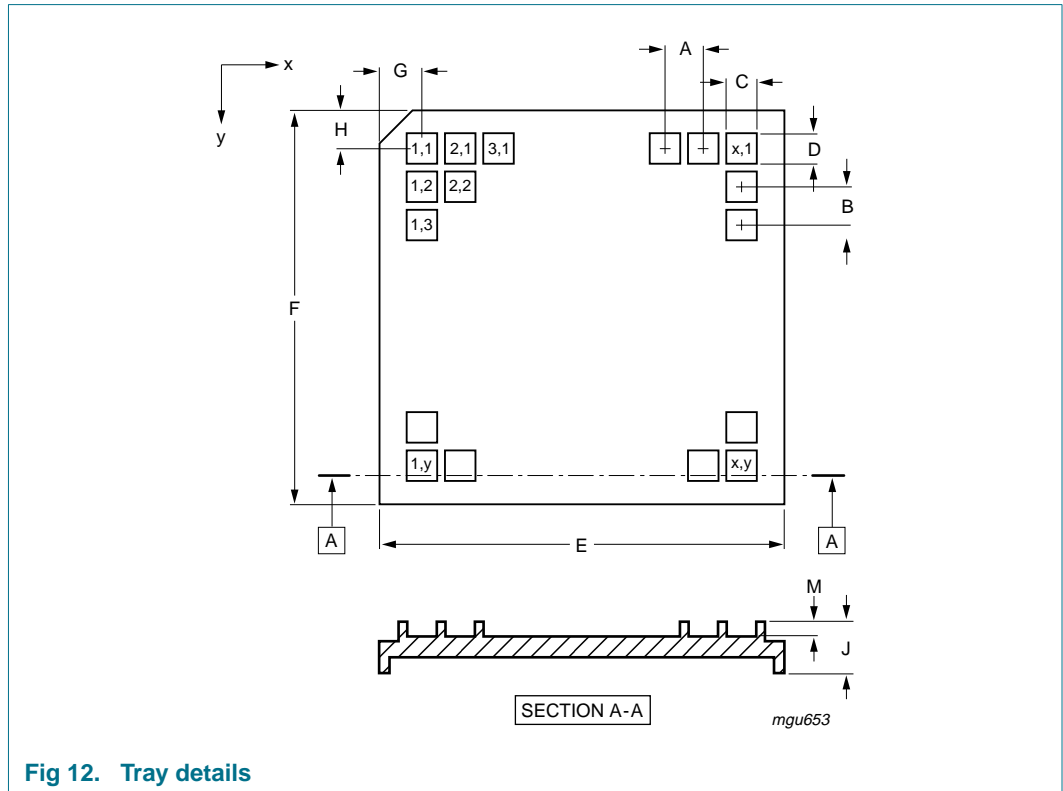
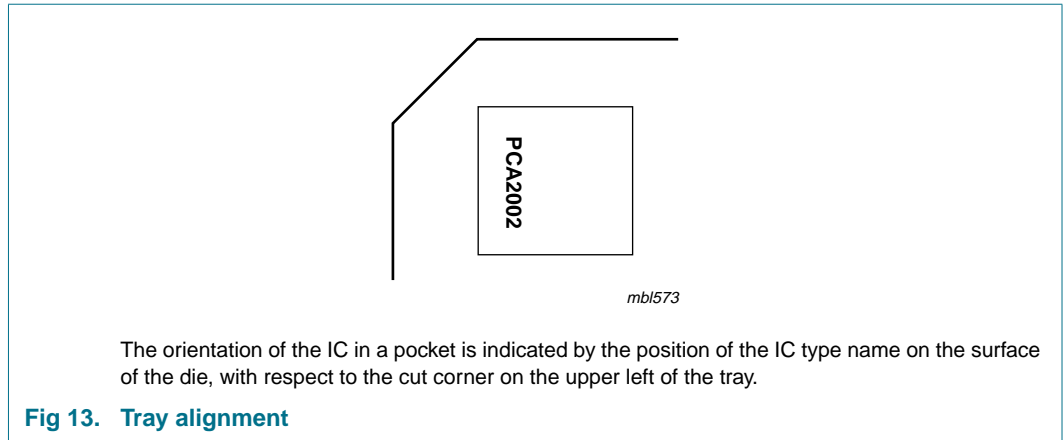
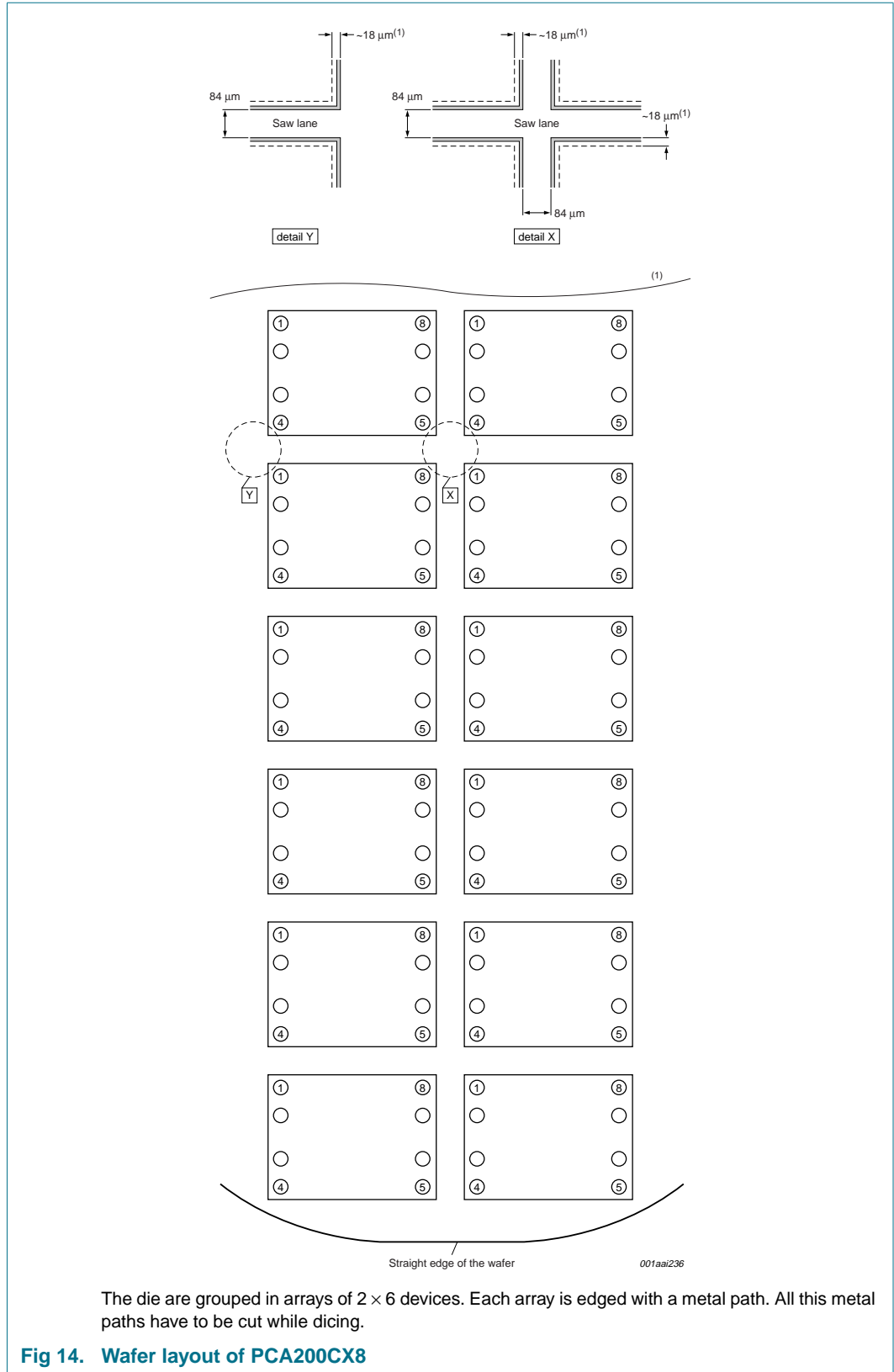

Table 12. Tray dimensions

Dimension	Description	Value
A	pocket pitch; x direction	2.15 mm
B	pocket pitch; y direction	2.43 mm
C	pocket width; x direction	1.01 mm
D	pocket width; y direction	1.39 mm
E	tray width; x direction	50.67 mm
F	tray width; y direction	50.67 mm
G	distance from cut corner to pocket (1 and 1) center	4.86 mm
H	distance from cut corner to pocket (1 and 1) center	4.66 mm
J	tray thickness	3.94 mm
M	pocket depth	0.61 mm
x	number of pockets in x direction	20
y	number of pockets in y direction	18



12.2 Unsaun wafer information



The die are grouped in arrays of 2 × 6 devices. Each array is edged with a metal path. All this metal paths have to be cut while dicing.

Fig 14. Wafer layout of PCA200CX8

13. Soldering of WLCSP packages

13.1 Introduction to soldering WLCSP packages

This text provides a very brief insight into a complex technology. A more in-depth account of soldering WLCSP (Wafer Level Chip-Size Packages) can be found in application note AN10439 "Wafer Level Chip Scale Package" and in application note AN10365 "Surface mount reflow soldering description".

Wave soldering is not suitable for this package.

All NXP WLCSP packages are lead-free.

13.2 Board mounting

Board mounting of a WLCSP requires several steps:

1. Solder paste printing on the PCB
2. Component placement with a pick and place machine
3. The reflow soldering itself

13.3 Reflow soldering

Key characteristics in reflow soldering are:

- Lead-free versus SnPb soldering; note that a lead-free reflow process usually leads to higher minimum peak temperatures (see [Figure 15](#)) than a PbSn process, thus reducing the process window
- Solder paste printing issues, such as smearing, release, and adjusting the process window for a mix of large and small components on one board
- Reflow temperature profile; this profile includes preheat, reflow (in which the board is heated to the peak temperature), and cooling down. It is imperative that the peak temperature is high enough for the solder to make reliable solder joints (a solder paste characteristic) while being low enough that the packages and/or boards are not damaged. The peak temperature of the package depends on package thickness and volume and is classified in accordance with [Table 13](#)

Table 13. Lead-free process (from J-STD-020C)

Package thickness (mm)	Package reflow temperature (°C)		
	Volume (mm ³)		
	< 350	350 to 2000	> 2000
< 1.6	260	260	260
1.6 to 2.5	260	250	245
> 2.5	250	245	245

Moisture sensitivity precautions, as indicated on the packing, must be respected at all times.

Studies have shown that small packages reach higher temperatures during reflow soldering, see [Figure 15](#).

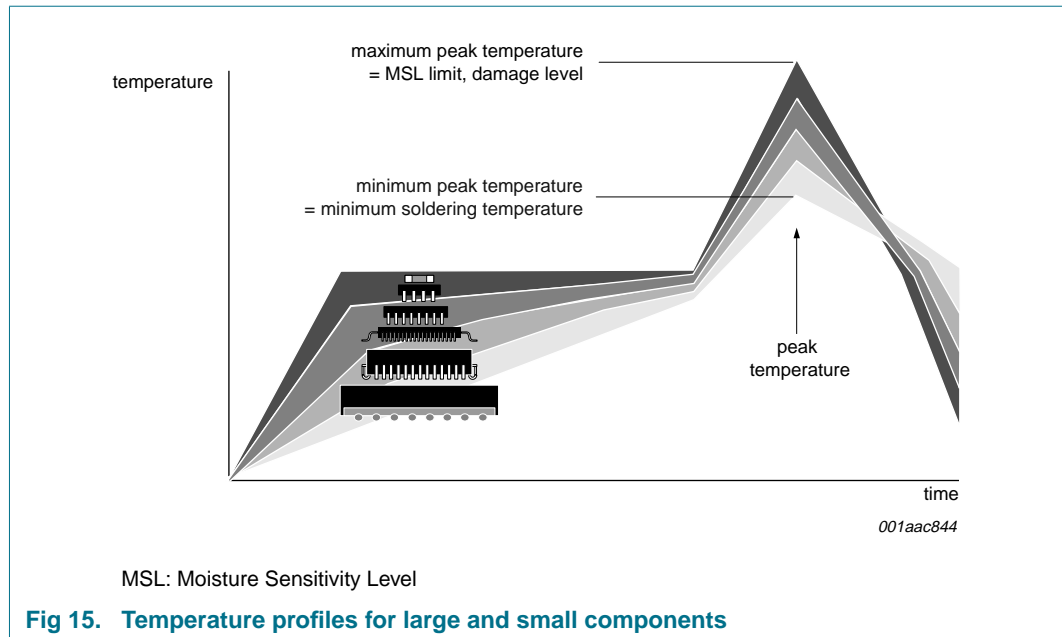

For further information on temperature profiles, refer to application note *AN10365 "Surface mount reflow soldering description"*.

13.3.1 Stand off

The stand off between the substrate and the chip is determined by:

- The amount of printed solder on the substrate
- The size of the solder land on the substrate
- The bump height on the chip

The higher the stand off, the better the stresses are released due to TEC (Thermal Expansion Coefficient) differences between substrate and chip.

13.3.2 Quality of solder joint

A flip-chip joint is considered to be a good joint when the entire solder land has been wetted by the solder from the bump. The surface of the joint should be smooth and the shape symmetrical. The soldered joints on a chip should be uniform. Voids in the bumps after reflow can occur during the reflow process in bumps with high ratio of bump diameter to bump height, i.e. low bumps with large diameter. No failures have been found to be related to these voids. Solder joint inspection after reflow can be done with X-ray to monitor defects such as bridging, open circuits and voids.

13.3.3 Rework

In general, rework is not recommended. By rework we mean the process of removing the chip from the substrate and replacing it with a new chip. If a chip is removed from the substrate, most solder balls of the chip will be damaged. In that case it is recommended not to re-use the chip again.

Device removal can be done when the substrate is heated until it is certain that all solder joints are molten. The chip can then be carefully removed from the substrate without damaging the tracks and solder lands on the substrate. Removing the device must be done using plastic tweezers, because metal tweezers can damage the silicon. The surface of the substrate should be carefully cleaned and all solder and flux residues and/or underfill removed. When a new chip is placed on the substrate, use the flux process instead of solder on the solder lands. Apply flux on the bumps at the chip side as well as on the solder pads on the substrate. Place and align the new chip while viewing with a microscope. To reflow the solder, use the solder profile shown in application note AN10365 "Surface mount reflow soldering description".

13.3.4 Cleaning

Cleaning can be done after reflow soldering.

14. Abbreviations

Table 14. Abbreviations

Acronym	Description
HBM	Human Body Model
LSB	Least Significant Bit
MM	Machine Model
MSB	Most Significant Bit
OTP	One Time Programmable

15. Revision history

Table 15. Revision history

Document ID	Release date	Data sheet status	Change notice	Supersedes
PCA2002_5	20081111	Product data sheet	-	PCA2002_4
Modifications:		<ul style="list-style-type: none">• The format of this data sheet has been redesigned to comply with the new identity guidelines of NXP Semiconductors.• Legal texts have been adapted to the new company name where appropriate.• Implemented new drawings and wafer information• Added new bare die outline drawing		
PCA2002_4	20050907	Product data sheet	-	PCA2002_3
PCA2002_3	20040120	Product specification	-	PCA2002_2
PCA2002_2	20030204	Objective specification	-	PCA2002_1
PCA2002_1	20021025	Objective specification	-	-

16. Legal information

16.1 Data sheet status

Document status ^{[1][2]}	Product status ^[3]	Definition
Objective [short] data sheet	Development	This document contains data from the objective specification for product development.
Preliminary [short] data sheet	Qualification	This document contains data from the preliminary specification.
Product [short] data sheet	Production	This document contains the product specification.

[1] Please consult the most recently issued document before initiating or completing a design.

[2] The term 'short data sheet' is explained in section "Definitions".

[3] The product status of device(s) described in this document may have changed since this document was published and may differ in case of multiple devices. The latest product status information is available on the Internet at URL <http://www.nxp.com>.

16.2 Definitions

Draft — The document is a draft version only. The content is still under internal review and subject to formal approval, which may result in modifications or additions. NXP Semiconductors does not give any representations or warranties as to the accuracy or completeness of information included herein and shall have no liability for the consequences of use of such information.

Short data sheet — A short data sheet is an extract from a full data sheet with the same product type number(s) and title. A short data sheet is intended for quick reference only and should not be relied upon to contain detailed and full information. For detailed and full information see the relevant full data sheet, which is available on request via the local NXP Semiconductors sales office. In case of any inconsistency or conflict with the short data sheet, the full data sheet shall prevail.

16.3 Disclaimers

General — Information in this document is believed to be accurate and reliable. However, NXP Semiconductors does not give any representations or warranties, expressed or implied, as to the accuracy or completeness of such information and shall have no liability for the consequences of use of such information.

Right to make changes — NXP Semiconductors reserves the right to make changes to information published in this document, including without limitation specifications and product descriptions, at any time and without notice. This document supersedes and replaces all information supplied prior to the publication hereof.

Suitability for use — NXP Semiconductors products are not designed, authorized or warranted to be suitable for use in medical, military, aircraft, space or life support equipment, nor in applications where failure or malfunction of an NXP Semiconductors product can reasonably be expected to result in personal injury, death or severe property or environmental damage. NXP Semiconductors accepts no liability for inclusion and/or use of NXP Semiconductors products in such equipment or applications and therefore such inclusion and/or use is at the customer's own risk.

Applications — Applications that are described herein for any of these products are for illustrative purposes only. NXP Semiconductors makes no representation or warranty that such applications will be suitable for the specified use without further testing or modification.

Limiting values — Stress above one or more limiting values (as defined in the Absolute Maximum Ratings System of IEC 60134) may cause permanent damage to the device. Limiting values are stress ratings only and operation of the device at these or any other conditions above those given in the Characteristics sections of this document is not implied. Exposure to limiting values for extended periods may affect device reliability.

Terms and conditions of sale — NXP Semiconductors products are sold subject to the general terms and conditions of commercial sale, as published at <http://www.nxp.com/profile/terms>, including those pertaining to warranty, intellectual property rights infringement and limitation of liability, unless explicitly otherwise agreed to in writing by NXP Semiconductors. In case of any inconsistency or conflict between information in this document and such terms and conditions, the latter will prevail.

No offer to sell or license — Nothing in this document may be interpreted or construed as an offer to sell products that is open for acceptance or the grant, conveyance or implication of any license under any copyrights, patents or other industrial or intellectual property rights.

Bare die — All die are tested on compliance with their related technical specifications as stated in this data sheet up to the point of wafer sawing and are handled in accordance with the NXP Semiconductors storage and transportation conditions. If there are data sheet limits not guaranteed, these will be separately indicated in the data sheet. There are no post-packing tests performed on individual die or wafers.

NXP Semiconductors has no control of third party procedures in the sawing, handling, packing or assembly of the die. Accordingly, NXP Semiconductors assumes no liability for device functionality or performance of the die or systems after third party sawing, handling, packing or assembly of the die. It is the responsibility of the customer to test and qualify their application in which the die is used.

All die sales are conditioned upon and subject to the customer entering into a written die sale agreement with NXP Semiconductors through its legal department.

16.4 Trademarks

Notice: All referenced brands, product names, service names and trademarks are the property of their respective owners.

17. Contact information

For more information, please visit: <http://www.nxp.com>

For sales office addresses, please send an email to: salesaddresses@nxp.com

18. Contents

1	General description	1
2	Features	1
3	Applications	1
4	Ordering information	2
5	Block diagram	2
6	Pinning information	3
6.1	Pinning	3
6.2	Pin description	3
7	Functional description	4
7.1	Motor pulse	4
7.2	Time calibration	4
7.3	Reset	5
7.4	Programming possibilities	5
7.5	Type recognition	6
7.6	Programming procedure	7
7.7	Programming the memory cells	8
7.8	Checking the memory content	9
7.9	Frequency tuning at assembled watch	10
7.10	Measurement of the oscillator frequency and the inhibition time	10
8	Limiting values	12
9	Characteristics	13
10	OTP programming characteristics	14
11	Bare die outline	15
12	Packing information	17
12.1	Tray information	17
12.2	Unsawn wafer information	19
13	Soldering of WLCSP packages	20
13.1	Introduction to soldering WLCSP packages ..	20
13.2	Board mounting	20
13.3	Reflow soldering	20
13.3.1	Stand off	21
13.3.2	Quality of solder joint	21
13.3.3	Rework	21
13.3.4	Cleaning	22
14	Abbreviations	22
15	Revision history	23
16	Legal information	24
16.1	Data sheet status	24
16.2	Definitions	24
16.3	Disclaimers	24
16.4	Trademarks	24
17	Contact information	24
18	Contents	25

Please be aware that important notices concerning this document and the product(s) described herein, have been included in section 'Legal information'.

founded by

PHILIPS

© NXP B.V. 2008.

All rights reserved.

For more information, please visit: <http://www.nxp.com>

For sales office addresses, please send an email to: salesaddresses@nxp.com

Date of release: 11 November 2008

Document identifier: PCA2002_5