



RXXLD20

Linear Integrated Circuit

2A OUTPUT TYPE LOW POWER-LOSS VOLTAGE REGULATOR

FEATURES

- *Low power-loss(Dropout voltage: 0.5V(max) at Io=2.0A)
- *2.0A output type
- *Output voltage precision: $\pm 3.0\%$
- *Built-in ON/OFF control function and over-current protection circuit.
- *Thermal shutdown protection.

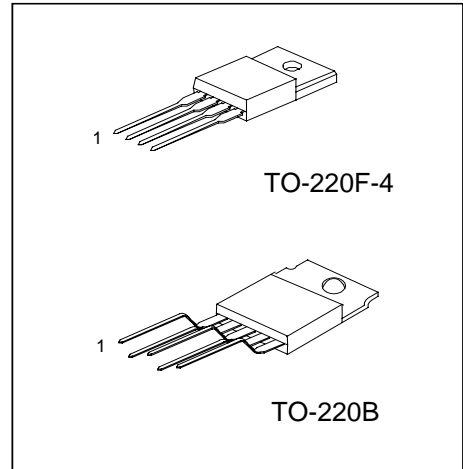

*Pb-free plating product number:RXXLD20L

PIN DESCRIPTION

PIN NO.		PIN NAME
TO-220F-4	TO-220B	
	1	NC
1	2	INPUT
2	3	OUTPUT
3	4	GND
4	5	ON/OFF

ORDERING INFORMATION

Order Number		Package	Packing
Normal	Lead Free Plating		
RXXLD20-TF4-T	RXXLD20L-TF4-T	TO-220F-4	Tube
RXXLD20-TB5-T	RXXLD20L-TB5-T	TO-220B	Tube

Note: xx: Output Voltage, refer to Marking Information.

MARKING INFORMATION

PACKAGE	VOLTAGE CODE	MARKING
TO-220F-4 TO-220B	33 :3.3V 05 :5.0V 09 :9.0V 12 :12 V	

■ BLOCK DIAGRAM

TO-220F-4

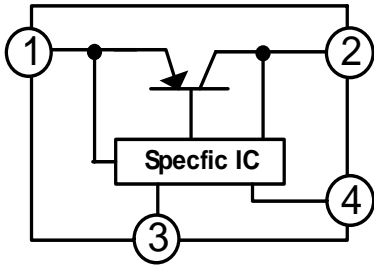

TO-220B

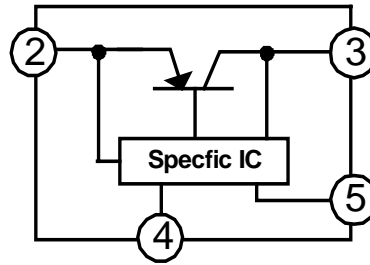

■ ABSOLUTE MAXIMUM RATINGS (Ta=25°C)

PARAMETER	SYMBOL	RATINGS	UNIT
Input Voltage	V _{IN}	20	V
ON/OFF Control Terminal Voltage	V _C	20	V
Output Current	I _{OUT}	2.0	A
Power Dissipation	No Heat Sink	1.4	W
	With Heat Sink	15	W
Junction Temperature	T _J	125	°C
Operating Temperature	T _{OPR}	-20 ~ +85	°C
Storage Temperature	T _{STG}	-40 ~ +150	°C

Note: The device is guaranteed to meet performance specification within 0°C~70°C operating temperature range and assured by design from -20°C~85°C, characteristic and correlation with static process control.

■ ELECTRICAL CHARACTERISTICS (Refer to the test circuits, unless otherwise specified, Ta=25°C)

For R33LD20(3.3V)

PARAMETER	SYMBOL	TEST CONDITIONS	MIN	TYP	MAX	UNIT
Output Voltage	V _{OUT}	V _{IN} =5V, I _{OUT} =1A	3.201	3.3	3.399	V
Line Regulation	ΔV _{OUT}	V _{IN} =4 ~ 10V, I _{OUT} =5mA		0.1	2.5	%
Load Regulation	ΔV _{OUT}	V _{IN} =5V, I _{OUT} =5mA ~ 2.0A		0.1	2.0	%
Temperature Coefficient of Output Voltage	TcVo	T _J =0 ~ 125°C, I _{OUT} =5mA		±0.02		%/°C
Ripple Rejection	RR	Refer to Fig.2	45	55		dB
Dropout Voltage	V _D	(Note1), I _{OUT} =2A			0.5	V
Voltage for Control(Note2)	ON	V _{C(ON)} V _{IN} =5V	2.0			V
	OFF	V _{C(OFF)} V _{IN} =5V			0.8	V
Current for Control	ON	I _{C(ON)} V _C =2.7V, V _{IN} =5V			20	μA
	OFF	I _{C(OFF)} V _C =0.4V, V _{IN} =5V			-0.4	mA
Quiescent Current	I _D	I _{OUT} =0A, V _{IN} =5V			10	mA

For R05LD20(5V)

PARAMETER	SYMBOL	TEST CONDITIONS	MIN	TYP	MAX	UNIT
Output Voltage	V _{OUT}	V _{IN} =7V, I _{OUT} =2\1A	4.85	5.0	5.15	V
Line Regulation	ΔV _{OUT}	V _{IN} =6 ~ 12V, I _{OUT} =5mA		0.5	2.5	%
Load Regulation	ΔV _{OUT}	V _{IN} =7V, I _{OUT} =5mA ~ 2.0A		0.1	2.0	%
Temperature Coefficient of Output Voltage	TcVo	T _J =0 ~ 125°C, I _{OUT} =5mA		±0.02		%/°C
Ripple Rejection	RR	Refer to Fig.2	45	55		dB
Dropout Voltage	V _D	(Note1), I _{OUT} =2A			0.5	V
Voltage for Control(Note2)	ON	V _{C(ON)} V _{IN} =7V	2.0			V
	OFF	V _{C(OFF)} V _{IN} =7V			0.8	V
Current for Control	ON	I _{C(ON)} V _C =2.7V, V _{IN} =7V			20	μA
	OFF	I _{C(OFF)} V _C =0.4V, V _{IN} =7V			-0.4	mA
Quiescent Current	I _D	I _{OUT} =0A, V _{IN} =7V			10	mA

For R09LD20(9V)

PARAMETER	SYMBOL	TEST CONDITIONS	MIN	TYP	MAX	UNIT
Output Voltage	V_{OUT}	$V_{IN}=11V, I_{OUT}=1A$	8.73	9.0	9.27	V
Line Regulation	ΔV_{OUT}	$V_{IN}=10 \sim 16V, I_{OUT}=5mA$		0.5	2.5	%
Load Regulation	ΔV_{OUT}	$V_{IN}=11V, I_{OUT}=5mA \sim 2.0A$		0.1	2.0	%
Temperature Coefficient of Output Voltage	$TcVo$	$T_J=0 \sim 125^{\circ}C, I_{OUT}=5mA$		± 0.02		%/ $^{\circ}C$
Ripple Rejection	RR	Refer to Fig.2	45	55		dB
Dropout Voltage	V_D	(Note1), $I_{OUT}=2A$			0.5	V
Voltage for Control(Note2)	ON	$V_{C(ON)}$ $V_{IN}=11V$	2.0			V
	OFF	$V_{C(OFF)}$ $V_{IN}=11V$			0.8	V
Current for Control	ON	$I_{C(ON)}$ $V_C=2.7V, V_{IN}=11V$			20	μA
	OFF	$I_{C(OFF)}$ $V_C=0.4V, V_{IN}=11V$			-0.4	mA
Quiescent Current	I_D	$I_{OUT}=0A, V_{IN}=11V$			10	mA

For R12LD20(12V)

PARAMETER	SYMBOL	TEST CONDITIONS	MIN	TYP	MAX	UNIT
Output Voltage	V_{OUT}	$V_{IN}=14V, I_{OUT}=1A$	11.64	12.0	12.36	V
Line Regulation	ΔV_{OUT}	$V_{IN}=13 \sim 19V, I_{OUT}=5mA$		0.5	2.5	%
Load Regulation	ΔV_{OUT}	$V_{IN}=14V, I_{OUT}=5mA \sim 2.0A$		0.1	2.0	%
Temperature Coefficient of Output Voltage	$TcVo$	$T_J=0 \sim 125^{\circ}C, I_{OUT}=5mA$		± 0.02		%/ $^{\circ}C$
Ripple Rejection	RR	Refer to Fig.2	45	55		dB
Dropout Voltage	V_D	(Note1), $I_{OUT}=2A$			0.5	V
Voltage for Control(Note2)	ON	$V_{C(ON)}$ $V_{IN}=14V$	2.0			V
	OFF	$V_{C(OFF)}$ $V_{IN}=14V$			0.8	V
Current for Control	ON	$I_{C(ON)}$ $V_C=2.7V, V_{IN}=14V$			20	μA
	OFF	$I_{C(OFF)}$ $V_C=0.4V, V_{IN}=14V$			-0.4	mA
Quiescent Current	I_D	$I_{OUT}=0A, V_{IN}=14V$			10	mA

Note: 1.Input voltage shall be the value when output voltage is 95% in comparison with the initial value.

2.In case of opening control terminal(pin 5 of TO-220B, pin 4 of TO-220F-4), output voltage turns on.

TEST CIRCUIT

Note : ○: TO-220F-4, (): TO-220B

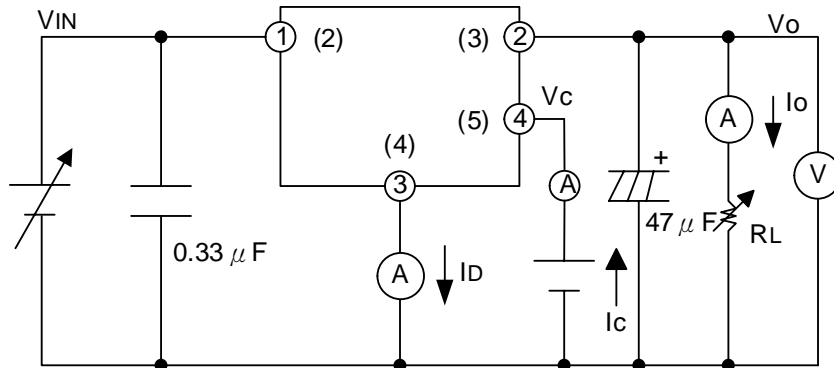
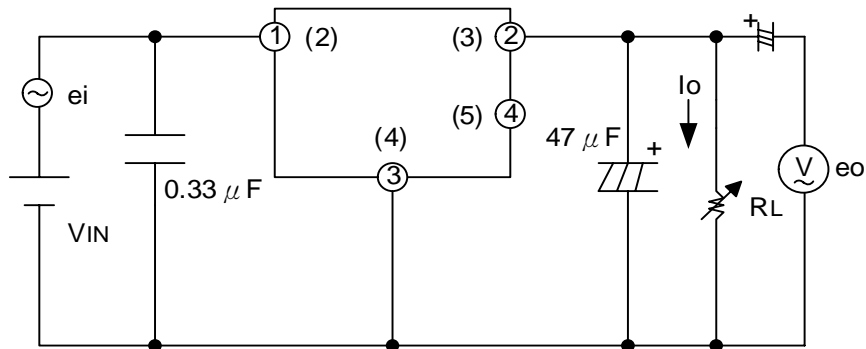

Fig.1



$V_{IN}=5V(R33LD30)$ $f=120Hz$
 $7V(R05LD30)$ $e_i=0.5V_{rms}$
 $11V(R09LD30)$ $i_o=0.5A$
 $14V(R12LD30)$ $RR=20\log(e_i/e_o)$

Fig.2 For Ripple Rejection

TYPICAL APPLICATION

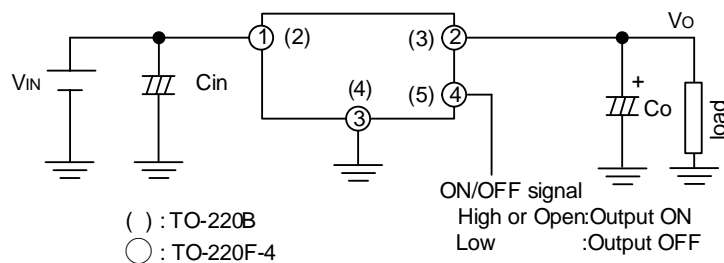

TYPICAL CHARACTERISTICS

Fig.3 Power Dissipation vs. Ambient Temperature

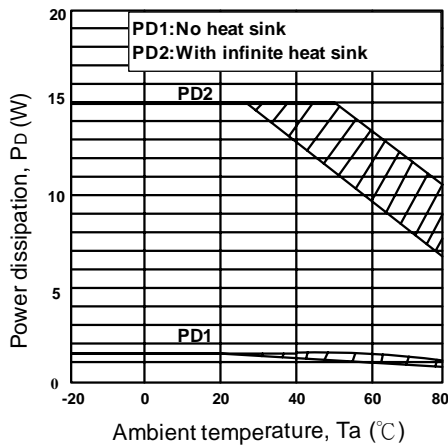

Note: Oblique line portion:Overheat protection may operate in this area .

Fig.4 Overcurrent Protection Characteristics(Typical Value) (R33LD20)

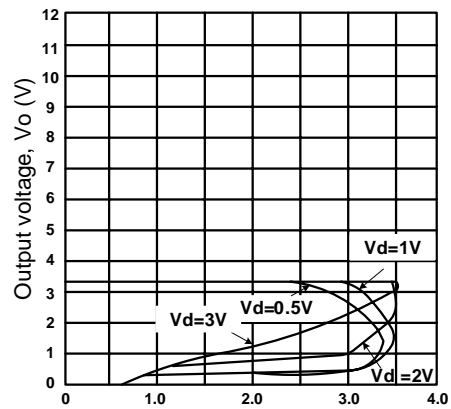

Fig.5 Overcurrent Protection Characteristics (Typical Value)(R05LD20)

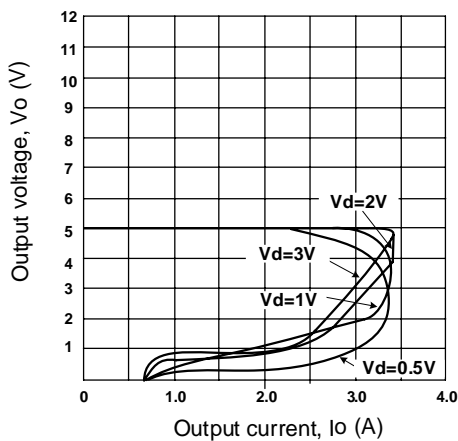

Fig.6 Overcurrent Protection Characteristics (Typical Value)(R09LD20)

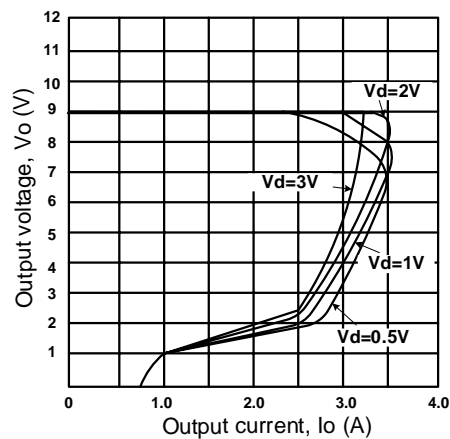

Fig.7 Overcurrent Protection Characteristics (Typical Value)(R12LD20)

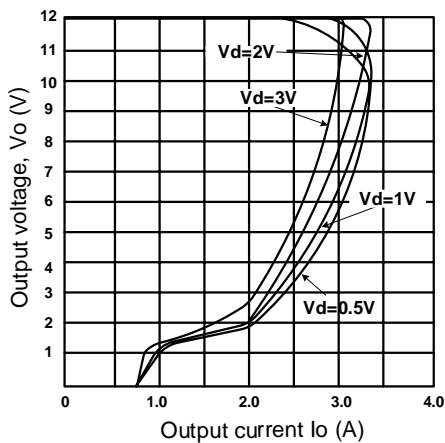
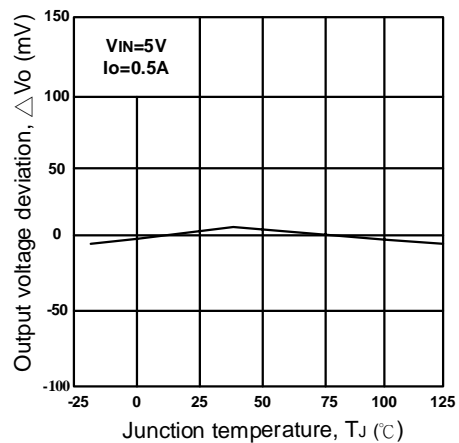

Fig.8 Output Voltage Deviation vs .Junction Temperature (R03LD20)



■ TYPICAL CHARACTERISTICS(cont.)

Fig.9 Output Voltage Deviation vs .Junction Temperature (R05LD20)

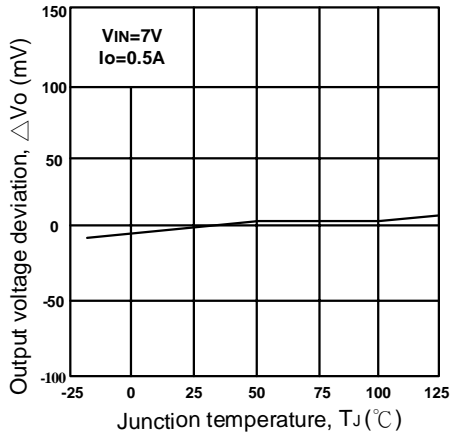

Fig.10 Output Voltage Deviation vs .Junction Temperature (R09LD20)

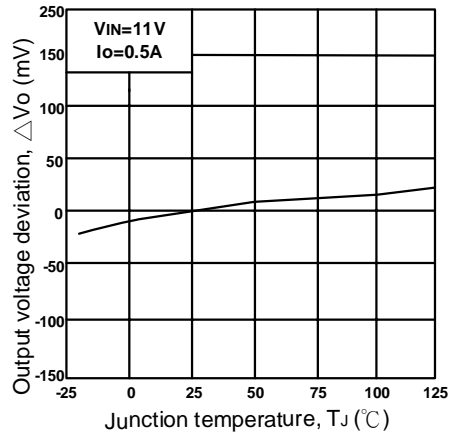

Fig.11 Output Voltage Deviation vs .Junction Temperature (R12LD20)

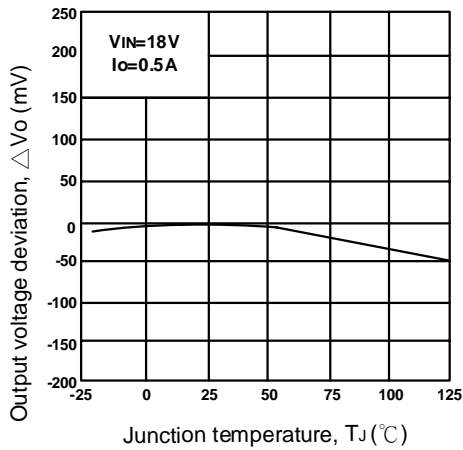

Fig.12 Output Voltage vs .Input Voltage (R33LD20)

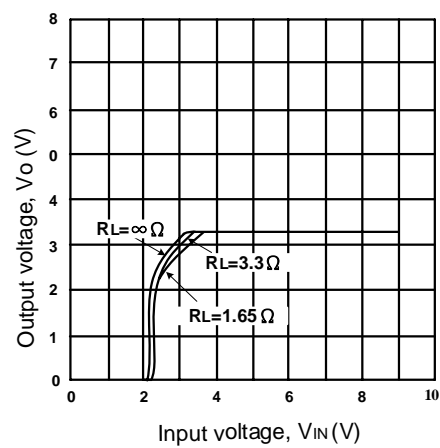

Fig.13 Output Voltage vs .Input Voltage (R05LD20)

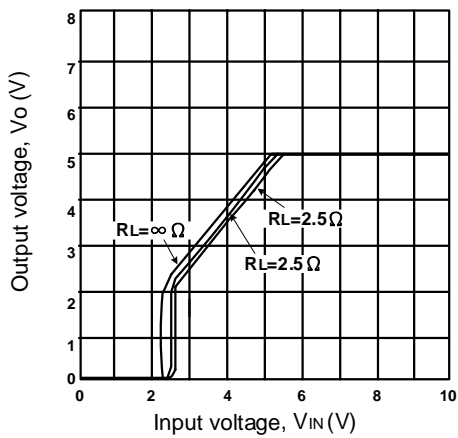
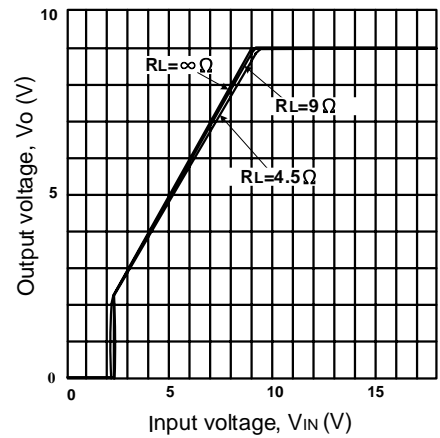

Fig.14 Output Voltage vs .Input Voltage (R09LD20)



TYPICAL CHARACTERISTICS(cont.)

Fig.15 Output Voltage vs .Input Voltage (R12LD30)

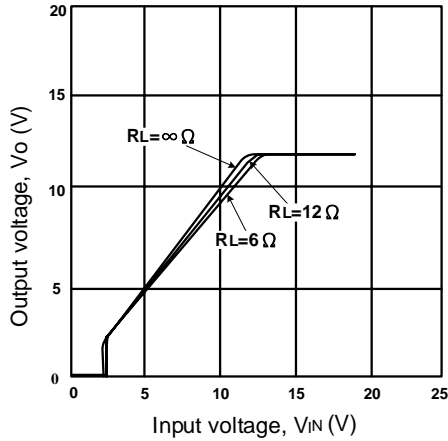

Fig.16 Circuit Operating Current vs .Input Voltage (R33LD30)

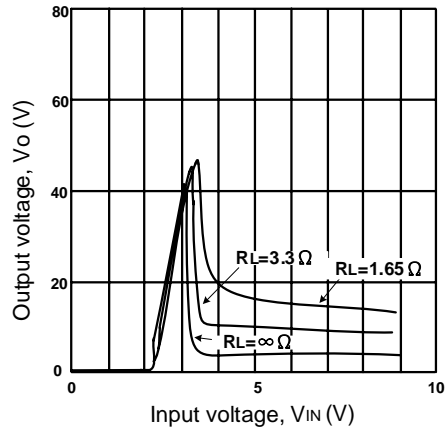

Fig.17 Circuit Operating Current vs .Input Voltage (R05LD30)

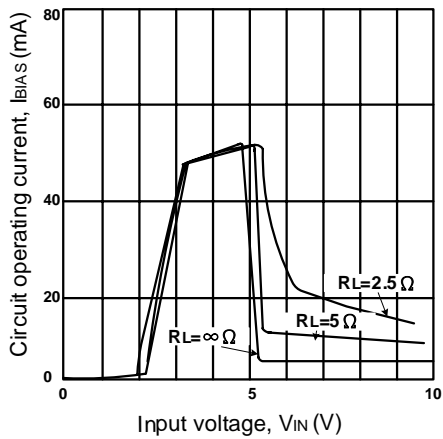

Fig.18 Circuit Operating Current vs .Input Voltage (R09LD30)

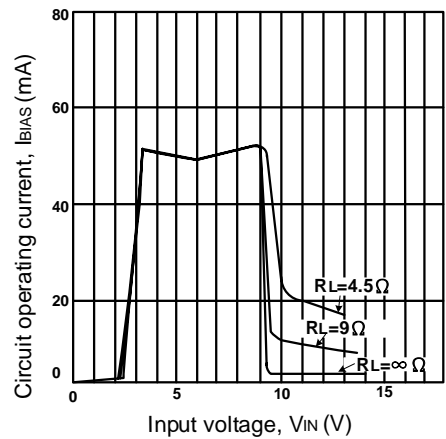

Fig.19 Circuit Operating Current vs .Input Voltage (R12LD30)

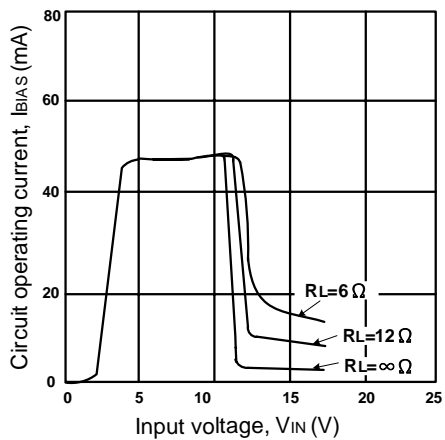
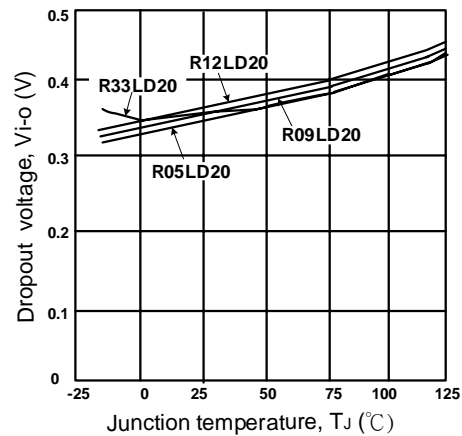

Fig.20 Dropout Voltage vs .Junction Temperature



■ TYPICAL CHARACTERISTICS(cont.)

Fig.21 Quiescent Current vs .Junction Temperature

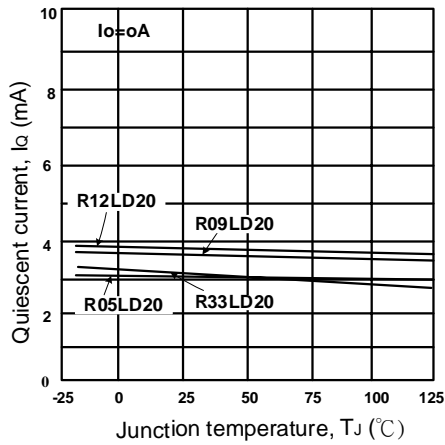
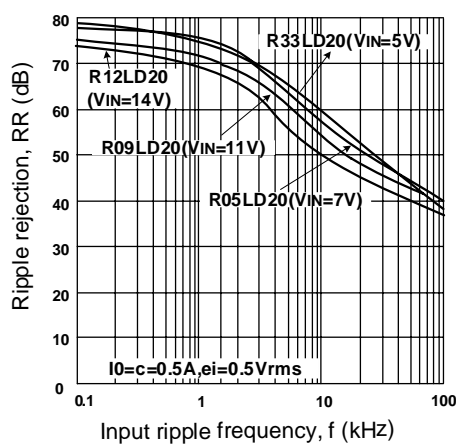

Fig.22 Ripple Rejection vs .Input Ripple Frequency



UTC assumes no responsibility for equipment failures that result from using products at values that exceed, even momentarily, rated values (such as maximum ratings, operating condition ranges, or other parameters) listed in products specifications of any and all UTC products described or contained herein. UTC products are not designed for use in life support appliances, devices or systems where malfunction of these products can be reasonably expected to result in personal injury. Reproduction in whole or in part is prohibited without the prior written consent of the copyright owner. The information presented in this document does not form part of any quotation or contract, is believed to be accurate and reliable and may be changed without notice.