

C&K Rafx 16 Series Selector Switches



Models Available
(Contact block only)

Features/Benefits

- Quick connect terminals
- Illuminated indicator available
- Momentary or latching
- 2 or 3 positions

Typical Applications

- Machine process control
- Printing machinery
- Metal working machinery

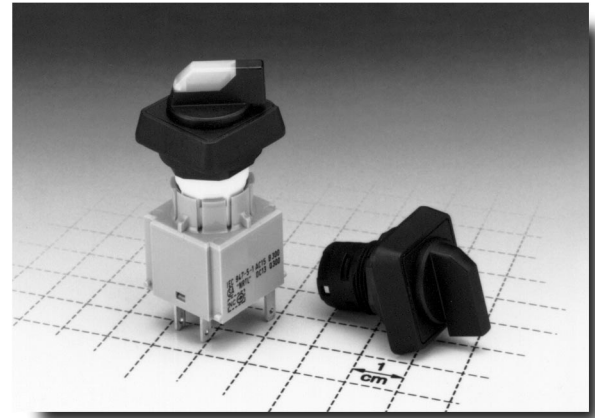

Rotary

How To Order

To order, select actuator and contact block part numbers. Accessories, filament lamps and LEDs available separately, see section L. Other frame styles, contact arrangements, lens colors, LEDs and flush models available, consult Customer Service Center.

Specifications

CONTACT RATING: Ag: 6 AMPS @ 250 V AC;
Au: 250 mA @ 42 V AC/DC.
CONTACT SYSTEM: Self cleaning bridge contact.
CONTACT ARRANGEMENT: 1 N.C. & 1 N.O./2 N.O./2 N.C.
CONTACT RESISTANCE: Ag: 20 mΩ; Au: < 50 mΩ.
ILLUMINATION: Wedge base filament lamp or LED.
FIXING: Hexagon nut
OPERATING LIFE: 30,000 cycles.
OPERATING TEMPERATURE: Non-illuminated: -25°C to +70°C;
-13°F to +158°F. Illuminated: -25°C to +55°C; -13°F to +131°F.

DEGREE OF PROTECTION: IP65; Dust-proof, water splash and dew condensation.

INDEXING: Varies by part number.

Materials

SWITCH HOUSING: PA.
COLLAR: PBTB.
CONTACT BLOCK HOUSING: PA 12.
LENS: PA 12.
CONTACT MATERIAL: Silver nickel/gold.
TERMINALS: Quick connect 2.8 x 0.8 tin plated.
FLAMMABILITY OF PLASTIC MATERIALS: UL 94V-0.

Illuminated Momentary and Latching Selector Switches

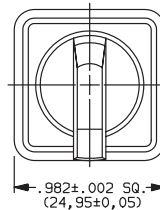
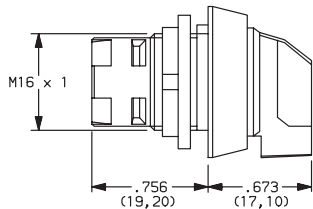

1.30073.5510241

SWITCH			HANDLE COLOR	
PART NUMBER	SWITCH CONFIGURATION	INDEXING	PART NUMBER	TRANSLUCENT COLOR
1.30073.551	POS. 1 	40° momentary	0241 0318 0417 0526 0619	White Red Yellow Green Blue
1.30073.651*	POS. 1 	40° momentary		
1.30073.501	POS. 1 	90° latching		
1.30073.601	POS. 1 	90° latching		
1.30073.701*	POS. 1 	60° latching		
1.30073.751*	POS. 1 	90° latching 40° momentary		

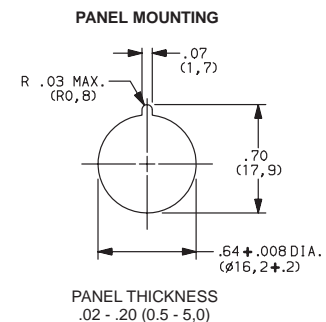

*Requires universal contact block.
All others require standard contact block.

C&K Rafix 16 Series Selector Switches

Standard Contact Block for illuminated Momentary and Latching Selector Switches

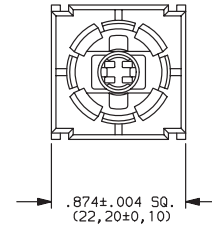
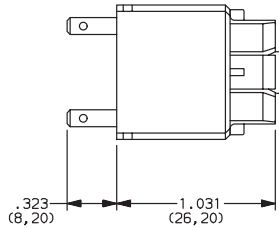

1.20122.0010000
1 N.C. + 1 N.O.

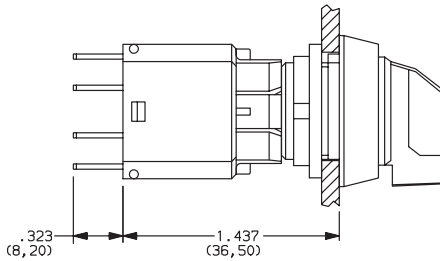

Contact Block with Momentary and Latching Selector Switch

STANDARD CONTACT BLOCK			
PART NUMBER	FUNCTION	MATERIAL/ CONTACT RATING	CONTACT ARRANGEMENT
1.20122.0010000 1.20122.0020000 1.20122.0030000	Momentary	Silver 250 V/ 6 A (4 A)	1 N.C. & 1 N.O. 2 N.O. 2 N.C.
1.20122.0110000 1.20122.0120000 1.20122.0130000	Momentary	Gold 42 V/ 250 mA	1 N.C. & 1 N.O. 2 N.O. 2 N.C.

Universal Contact Block for illuminated Momentary and Latching Selector Switches

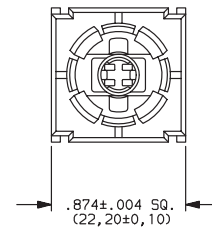
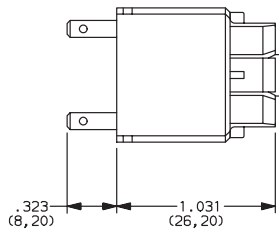

1.20123.0010000
1 N.C. + 1 N.O.

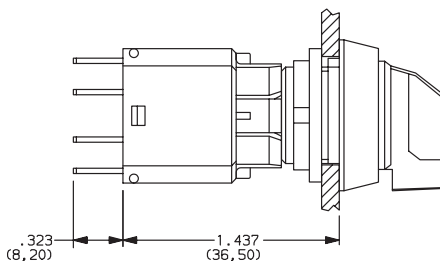

Contact Block with Momentary and Latching Selector Switch

UNIVERSAL CONTACT BLOCK			
PART NUMBER	FUNCTION	MATERIAL/ CONTACT RATING	CONTACT ARRANGEMENT
1.20123.0010000 1.20123.0020000 1.20123.0030000 1.20123.0040000 1.20123.0050000	Momentary	Silver 250 V/ 6 A (4 A)	1 N.C. & 1 N.O. 1 N.C. 1 N.O. 2 N.C. 2 N.O.
1.20123.0110000 1.20123.0120000 1.20123.0130000 1.20123.0140000 1.20123.0150000	Momentary	Gold 42 V/ 250 mA	1 N.C. & 1 N.O. 1 N.C. 1 N.O. 2 N.C. 2 N.O.



Rotary

C&K Rafx 16 Series Selector Switches

Non-illuminated Momentary and Latching Selector Switches

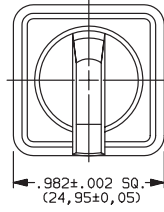
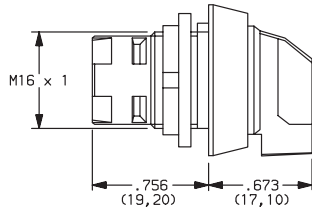

1.30073.550.0200

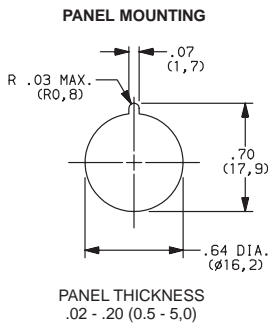

SWITCH			HANDLE COLOR	
PART NUMBER	FUNCTION	SWITCH CONFIGURATION	PART NUMBER	COLOR
1.30073.550	1 x 40° momentary	POS. 1 2	0200	Opaque white
1.30073.650*	2 x 40° momentary	POS. 1 3 2		
1.30073.500	1 x 90° latching	POS. 1 2		
1.30073.600	1 x 90° latching	POS. 1 2		
1.30073.700*	2 x 60° latching	POS. 1 3 2		
1.30073.750*	1 x 90° latching 1 x 40° momentary	POS. 1 3 2		

*Requires universal contact block. All others require standard contact block.

Standard Contact Block for Non-illuminated Momentary and Latching Selector Switches

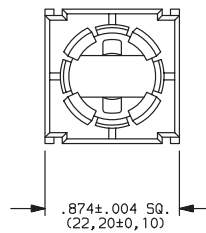
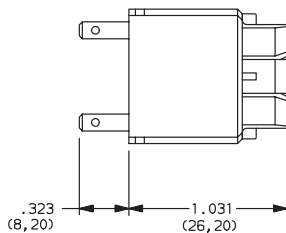

1.20122.0210000

1 N.C. + 1 N.O.

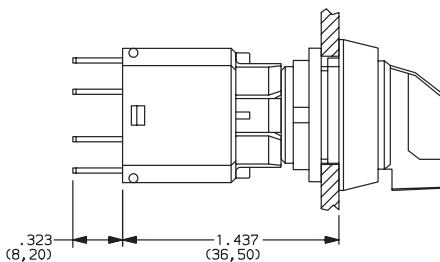

Contact Block with Momentary and Latching Selector Switch

STANDARD CONTACT BLOCK			
PART NUMBER	FUNCTION	MATERIAL/ CONTACT RATING	CONTACT ARRANGEMENT
1.20122.0210000 1.20122.0220000 1.20122.0230000	Momentary	Silver 250 V/ 6 A (4 A)	1 N.C. & 1 N.O. 2 N.O. 2 N.C.
1.20122.0310000 1.20122.0320000 1.20122.0330000	Momentary	Gold 42 V/ 250 mA	1 N.C. & 1 N.O. 2 N.O. 2 N.C.

C&K Rafix 16 Series Selector Switches

Universal Contact Block for Non-illuminated
Momentary and Latching Selector Switches



1.20123.0210000
1 N.C. + 1 N.O.

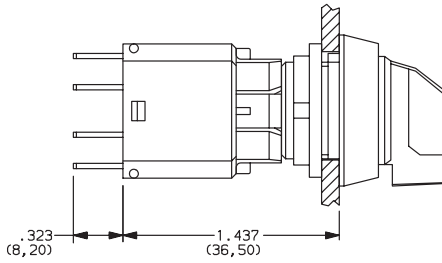
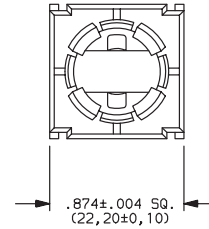
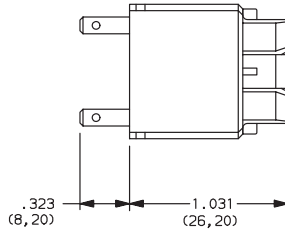

Contact Block with Momentary
and Latching Selector Switch

UNIVERSAL CONTACT BLOCK			
PART NUMBER	FUNCTION	MATERIAL/ CONTACT RATING	CONTACT ARRANGEMENT
1.20123.0210000	Momentary	Silver 250 V/ 6 A (4 A)	1 N.C. & 1 N.O.
1.20123.0220000			1 N.C.
1.20123.0230000			1 N.O.
1.20123.0240000			2 N.C.
1.20123.0250000			2 N.O.
1.20123.0310000	Momentary	Gold 42 V/ 250 mA	1 N.C. & 1 N.O.
1.20123.0320000			1 N.C.
1.20123.0330000			1 N.O.
1.20123.0340000			2 N.C.
1.20123.0350000			2 N.O.

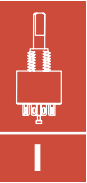

Rotary